

# ESTCO

From Facility to Everyday Utility

ISO 9001 CERTIFIED | ISO | IMSG | RoHS Compliant  
ISO 9001 CERTIFIED | CERTIFICATE #08-511

VERS. 05

# SUPPLY CATALOG

ENGINEERING SOLUTIONS  
THROUGH QUALITY PRODUCTS



OVER  
FIFTEEN MILLION  
INVENTORIED  
ITEMS!

# FORWARD

## STANDARD MOLDED PARTS

This catalog represents one of the most extensive offerings of standard molded rubber small parts. Its value lies in its use. Tremendous savings in new mold and tooling charges can be accomplished if engineers and designers will use tooling that is already in existence such as illustrated in this catalog. The illustrations indicate parts as molded in a standard rubber compound, however variations from this standard can be obtained by requesting other materials, hardness or colors.

We have made some significant improvements in the usability of this book. Grommets, bumpers, and other molded parts are now listed in the order of their sizes by at least one critical dimension. We've also added metric and decimal equivalents to all standard molded parts except those of irregular design.

## MOLDED SPECIAL PARTS

Where standard parts are not usable, savings in special rubber parts can result by contacting a specialist in molding of small parts. Special techniques and equipment are used which cannot be used by a general rubber manufacturer. This means lower mold costs, better piece price, with the capability of continued large volume production.

## GENERAL INFORMATION

For your guidance, and quick reference, we have included a complete new section which outlines, in general, the characteristics of the most common elastomers used in the manufacturing of small molded parts. In addition there is extensive engineering information including an explanation of ASTM D-2000 and tolerance tables.

## HOLD HARMLESS PROVISION

The Purchaser agrees to and does indemnify and hold the Manufacturer harmless against any claims, actions, causes of action, or other legal proceedings which might be brought against the Manufacturer by the ultimate user of the product, or others, for injury or other damages which might be occasioned by the use in any manner of the product. Such indemnity and hold harmless shall apply whether such action is based upon a theory of negligence on the part of Manufacturer, breach of warranty by the Manufacturer (whether express or implied), strict liability, or other. The Purchaser will, if requested by the Manufacturer, assume the defense of any action or other proceeding and will pay on behalf of the Manufacturer the amount of any costs, judgments or penalties entered or incurred by the Manufacturer in such action, including attorney's fees.

# GLOSSARY OF RUBBER TERMS

## **ABRASION RESISTANCE**

This property may be defined as the resistance to abrasive wear. It is very important in tire treads, soles and heels, hose, and the covers of conveyor belts and cables.

## **ACID RESISTANCE**

The resistance to action of acid either concentrated or diluted.

## **ACRYLIC**

Polymer for which resistance to air and hot oil at temperatures above 300°F are required.

## **AGING**

Accelerated aging tests are run on various rubbers to find out in as short a period as possible the destructive influence of light, oxygen, heat and ozone. Natural or shelf aging requires many years for proper evaluation, so accelerated aging tests will give comparative values in short periods of time; however, there is no absolute correlation between natural aging and accelerated aging.

## **ATMOSPHERIC AGING RESISTANCE**

The loss of physical properties due to the normal action of its surroundings (weather).

## **BUNA-S**

See SBR.

## **BUTAPRENE**

See Nitrite Rubber.

## **BUTYL**

Copolymer of isobutylene and isoprene. (Commonly used for inner tubes.)

## **CHEMIGUM**

See Nitrite Rubber.

## **COMPRESSION SET**

This property is similar to permanent set in that it has a tendency to take a permanent deformation under application of stress. It is actually a characteristic of liquids and is sometimes referred to as hot-flow or cold-flow. It is measured (1) as the amount by which a standard test piece fails to return to its original thickness after being subjected to a standard compressive load or deflection for a fixed period of time; or (2) as the distance returned relative to the amount deflected.

## **CORONA RESISTANCE**

The ability of rubber acting as an insulator to withstand the effects of high voltage discharge. Indication of failure appears as surface cracks.

## **DIELECTRIC PROPERTIES**

The ability of material to resist the puncture due to electrical stress. This property is expressed in terms of volts per MIL thickness.

## **DUROMETER**

See Hardness.

## **ELASTOMER**

A term used to describe elastic polymers with rubber-like behavior.

## **ELONGATION**

The term "elongation" is used to describe the ability of a rubber compound to stretch without breaking. To describe this property as measured it is more accurate to speak of "ultimate elongation" or "elongation at break" since its value, expressed as per cent of original length, is taken at the moment of rupture.

## **EPDM (EPT, NORDEL)**

Terpolymer of ethylene - propylene - diene (noted for excellent ozone resistance).

## **FLAME RESISTANCE**

The resistance to burning or material that will not support combustion under ordinary conditions.

## **FLEX CRACKING**

Rubber articles subjected to repeated flexing have been found to develop small cracks on the surface.

## **FLUOROCARBON**

A polymer designed to meet the most rigid requirements. (Viton A, Fluorel) in oils, solvents, synthetic lubricants and corrosive chemicals, at elevated temperatures.

## **GRS**

See SBR

## **HARDNESS (DUROMETER)**

Hardness as a property of rubber stocks is difficult to define except according to the methods used to determine it. These methods measure the resistance of the stock to indentation by the blunt point of a metal rod, ball or needle. Thus the hardness of rubber can best be described as resistance to indentation. Various instruments measure indentation. The most common instrument used on rubber is the Durometer. Several scales are used depending on the hardness range (00, 0, A, B, C, D), but the A scale, ASTM 02240, is used for most compounds. Readings on each scale are from 0 to 100. Durometer hardness is a convenient nondestructive method of testing which can also be correlated to other properties such as tensile strength, tensile modulus, plasticity, and resilience. Since indentation hardness is dependent upon elastic modulus and viscoelastic behavior of the compound, rubber compounds which are not completely elastic will "creep" during the test. This creep should be noted as the difference between the initial hardness reading after 15 seconds of engagement with the specimen. A properly noted reading: Durometer A 61, creep 4 at 15 seconds. 73°F.

## **HEAT RESISTANCE**

The ability of rubber to retain its useful properties under the destructive influence of heat.

## **HYDROCARBON SOLVENTS - AROMATIC**

Solvents having basic benzene structure, usually coal tar types such as benzene, toluene and xylene.

## **HYPALON**

A polymer that is completely resistant to ozone attack under the most extreme conditions; possesses excellent color stability plus the action of acids, bases, and many other chemicals.

# GLOSSARY OF RUBBER TERMS CONT.

## **LOW TEMPERATURE FLEXIBILITY**

The temperature at which the rubber becomes too stiff to function in its intended manner.

## **NEOPRENE (GR-M)**

A polymer of chloroprene which is prepared from coal, salt and limestone.

## **NITRILE RUBBER (BUNA-N)**

Copolymer of butadiene and acrylonitrile. Butadiene generally is derived from petroleum and acrylonitrile from ethylene oxide and hydrogen cyanide. Names for Nitrile rubbers include: Butraprene, Chemigum, Hycar, Perbunan and Paracril.

## **NON-AROMATIC**

Straight chain organic carbon structures such as petroleum type solvents.

## **OXIDATION RESISTANCE**

The ability of rubber to resist the reaction of atmospheric oxygen.

## **PERMANENT SET**

When a piece of rubber is stretched and released it does not return to its exact original length but comes to rest somewhat longer than it was before stretching. The increase in length of the rubber strip, expressed as per cent of its original length, is termed "permanent set."

## **PERMEABILITY**

Ability or ease in which a liquid or gas can pass through a film of rubber.

## **PH**

Determine the concentration of either an acid or base.

## **PLASTICITY**

When subjected to sufficient shearing stress any given body will be deformed. If, after the stress is removed there is no recovery, the body is completely elastic. A proper balance between these two factors is required. The three methods most commonly used in measuring the amount of plasticity in an unvulcanized rubber stock are the Williams Plastometer and the Mooney Viscometer and the Firestone Plastometer. These machines measure the plasticity by compression, shear and extrusion respectively.

## **POLYMER**

A term used to express the new material formed by a polymerization reaction.

## **POLYMERIZATION**

Chemical reaction whereby simple materials, either one or more, are converted to a complex material which possesses properties entirely different than original materials used at the start of the reaction.

## **POLYURETHANE**

An organic material noted for its high abrasion, ozone, corona and radiation characteristics.

## **PURE GUM STATE**

A non-pigmented, translucent, basic polymer.

## **RESILIENCE**

Capability of a material to return to its original size and shape after deformation. It is generally expressed in percentage of ratio of energy returned by rubber to the energy used in compressing rubber.

## **RUBBER, NATURAL**

Most commonly used forms are smoked sheet and pale crepe organic material-latex.

## **S.A.E.**

Society of Automotive Engineers.

## **SBR**

Copolymer of Butadiene and Styrene. Butadiene is a gaseous material generally obtained from Petroleum, and Styrene is a reaction product of ethylene and benzene. SBR is an all-purpose type synthetic similar to natural rubber.

## **SILICONE RUBBER**

A semi-organic material containing a silicone.

## **SPECIFIC GRAVITY**

The ratio of the weight to the given bulk to that of the same bulk of water (solids and liquids).

## **TEAR RESISTANCE**

The resistance to growth of a nick or cut when tension is applied to the cut specimen. (ASTM D-624).

## **TENSION MODULUS**

The term "modulus" or "stress" is used to denote resistance to being stretched. It is defined as the force in pounds necessary to stretch a piece of rubber, one square inch in cross section, a specified amount. This amount of stretch is normally expressed as a percentage of original length and the "stress" as pounds per square inch at the fixed elongation.

## **TENSILE STRENGTH**

The tensile strength of a rubber compound is in its resistance to rupture under tension. It is measured as strength at break and expressed in pounds per square inch of cross section. This property has an absolute value in some applications where the product is actually subjected to tension in service but, like the other tensile properties, it is most frequently used in evaluating compounding materials on a cooperative basis. In a series of cures with a variable time factor the tensile strength either passes through a maximum or exhibits a marked change in the slope of its curve. Therefore, the tensile strength may be considered either separately or together with the modulus and elongation in defining an optimum state of cure for any specific compound.

## **THIOKOL**

An organic polysulfide.

## ASTM D-2000

### Classification System for Elastometric Materials

#### Example: 2BA610 A14 C12 L14

While not a part of the specification itself, the following chart presents the assigned material prefix letters and the polymer such prefix would normally call out. This is the conversion equivalent applicable under:

D-2000 and J-200	D-735 and J-14
AA-Natural, SBR, Butyl, Isoprene.....	R
AK-Polysulphide.....	SA
BA-Ethylene-Propylene, Heat Resistant SBR and Butyl.....	-
BC-Chloroprene-Neoprene.....	SC
BE-Chloroprene-Neoprene (lower oil swell and comp.set)....	-
BF-Nitrile-E24-E34 Requirements.....	-
BG-Nitrile-E51-E61 Requirements.....	SB
BK-Organic Thialide (Thiokol).....	SA
CA-Ethylene-Propylene.....	-
CE-Chlorosulfanated Polyethylene (Hypalon).....	-
CH-Nitrile.....	-
DF-Polyacrillic (Butyl-Acrylate Type).....	-
DH-Polyacrillic.....	TB
FC-Silicone.....	TA
FE-Silicone.....	-
FK-Fluorinated Silicone.....	-
GE-Silicone.....	-
HK-Fluorinated Elastomers (Viton TM*).....	-

#### 1st Designate (2)

Grade number - used to designate supplemental requirements beyond the basic call out. Your supplier can develop this.

#### 2nd Designate (B)

Indicative of heat resistant requirements at which polymer shall be tested. (See Table 1.)

**Table 1**

Basic Requirements for establishing type by temperature.

Test Temperature Type	°C	°F	Test Temperature Type	°C	°F
A	70	158	F	200	392
B	100	212	G	225	437
C	125	257	H	250	482
D	150	302	J	275	527
E	175	347			

#### 3rd Designate (A)

Indicative of degree oil resistance as measured by volume swell under test procedures. (See Table 2.)

**Table 2**

Basic Requirements for establishing class by volume swell.

Class	Volume Swell, Max. %	Class	Volume Swell, Max. %
A	No Requirement	F	60
B	140	G	40
C	120	H	30
D	100	J	20
E	80	K	10

#### 4th Designate (6)

Indicative of hardness required, as 60±5 Shore "A".

#### 5th & 6th Designate (1 & 0)

Indicative of tensile strength required, as 1,000 PSI written in hundreds of PSI.

#### 7th Designate

The suffix letters (A, C, L) indicate supplemental requirements for particular applications that set up more rigid test procedures - beyond the basic call out. (See Table 3.)

**Table 3**

Meaning of Suffix Letters

Suffix Letter	Test Required
A	Heat Resistance
B	Compression Set
C	Ozone or Weather Resistance
D	Compression Deflection Resistance
E	Fluid Resistance
F	Low Temperature Resistance
G	Tear Resistance
H	Flex Resistance
J	Abrasion Resistance
K	Adhesion
L	Water Resistance
M	Flammability Resistance
N	Impact Resistance
P	Staining Resistance
R	Resilience
Z	Any special requirement to be specified in detail.

#### 8th Designate

The suffix numbers (14, 12, 14) indicate the ASTM test method applicable by the first digit.

#### 9th Designate

The suffix numbers, (in this case 14-12-14) the second digit denotes the temperature at which the test shall be conducted. (See Table 5.)

**Table 5**

For Suffix Letters A, B, C, E, G, K, & L	For Suffix Letter F
1 = 73 Deg. F.	4 = Zero Deg. F.
2 = 100 Deg. F.	5 = Minus 13 Deg. F.
3 = 158 Deg. F.	6 = Minus 31 Deg. F.
4 = 212 Deg. F.	7 = Minus 40 Deg. F.
5 = 257 Deg. F.	8 = Minus 58 Deg. F.
6 = 302 Deg. F.	9 = Minus 67 Deg. F.
	10 = Minus 85 Deg. F.
	11 = Minus 103 Deg. F.

\* Viton is a registered trademark of DuPont

## TABLES FOR CONVERSION FROM INCHES INTO MILLIMETERS

DECIMALS    MILLIMETERS

DECIMALS    MILLIMETERS

	1/64.....	0.015625.....	.0397
	1/32.....	.03125.....	0.794
	3/64.....	.046875.....	1.191
	<b>1/16.....</b>	<b>.0625.....</b>	<b>1.588</b>
<b>1/8</b>	5/64.....	.078125.....	1.984
	3/32.....	.09375.....	2.381
	7/64.....	.109375.....	2.778
	.....	<b>.1250.....</b>	<b>3.175</b>
	9/64.....	.140625.....	3.572
	5/32.....	.15625.....	3.969
	11/64.....	.171875.....	4.366
	<b>3/16.....</b>	<b>.1875.....</b>	<b>4.763</b>
	13/64.....	.203125.....	5.159
	7/32.....	.21875.....	5.556
<b>1/4</b>	15/64.....	.234375.....	5.953
	.....	<b>.2500.....</b>	<b>6.350</b>
	17/64.....	.265625.....	6.747
	9/32.....	.28125.....	7.144
	19/64.....	.296875.....	7.541
	<b>5/16.....</b>	<b>.3125.....</b>	<b>7.938</b>
	21/64.....	.328125.....	8.334
	11/32.....	.34375.....	8.731
<b>3/8</b>	23/64.....	.359375.....	9.128
	.....	<b>.3750.....</b>	<b>9.525</b>
	25/64.....	.390625.....	9.922
	13/32.....	.40625.....	10.319
	27/64.....	.421875.....	10.716
	<b>7/16.....</b>	<b>.4375.....</b>	<b>11.113</b>
	29/64.....	.453125.....	11.509
	15/32.....	.46875.....	11.906
<b>1/2</b>	31/64.....	.484375.....	12.303
	.....	<b>.5000.....</b>	<b>12.700</b>

1 mm = .03937"

	33/64.....	0.515625.....	13.097
	17/32.....	.53125.....	13.494
	35/64.....	.546875.....	13.891
	<b>9/16.....</b>	<b>.5625.....</b>	<b>14.288</b>
<b>5/8</b>	37/64.....	.578125.....	14.684
	19/32.....	.59375.....	15.081
	39/64.....	.609375.....	15.478
	.....	<b>.6250.....</b>	<b>15.875</b>
	41/64.....	.640625.....	16.272
	21/32.....	.65625.....	16.669
	43/64.....	.671875.....	17.066
	<b>11/16.....</b>	<b>.6875.....</b>	<b>17.463</b>
	45/64.....	.703125.....	17.859
	23/32.....	.71875.....	18.256
<b>3/4</b>	47/64.....	.734375.....	18.653
	.....	<b>.7500.....</b>	<b>19.050</b>
	49/64.....	.765625.....	19.447
	25/32.....	.78125.....	19.844
	51/64.....	.796875.....	20.241
	<b>13/16.....</b>	<b>.8125.....</b>	<b>20.638</b>
	53/64.....	.828125.....	21.034
	27/32.....	.84375.....	21.431
<b>7/8</b>	55/64.....	.859375.....	21.828
	.....	<b>.8750.....</b>	<b>22.225</b>
	57/64.....	.890625.....	22.622
	29/32.....	.90625.....	23.019
	59/64.....	.921875.....	23.416
	<b>15/16.....</b>	<b>.9375.....</b>	<b>23.813</b>
	61/64.....	.953125.....	24.209
	31/32.....	.96875.....	24.606
<b>1</b>	63/64.....	.984375.....	25.003
	.....	<b>1.000.....</b>	<b>25.400</b>

.001" = .0254 mm

MULTIPLY BY	FROM → TO		MULTIPLY BY
	← TO	← FROM	
0.0394	inch	millimeter	25.4
0.0016	inch <sup>2</sup>	millimeter <sup>2</sup>	645.16
0.061	inch <sup>3</sup>	centimeter <sup>3</sup>	16.3871
0.2642	gallon (U.S.)	liter	3.7854
0.03527	oz. (avdp.)	gram	28.3495
2.2044	pound	kilogram	0.4536
62.43	lbs/ft <sup>3</sup>	g/cm <sup>3</sup>	0.0160
1.8°C + 32	°F	°C	(°F-32)/1.8
0.145	psi	kPa	6.8948
14.2247	psi	kg/cm <sup>3</sup>	0.0703

# GAUGE THICKNESS CONVERSION TABLE

Gauge	Inches	Millimeters
0	.325	8.26
1	.289	7.35
2	.257	6.54
3	.229	5.83
4	.204	5.19
5	.182	4.62
6	.162	4.12
7	.144	3.66
8	.128	3.26
9	.114	2.91
10	.102	2.59
11	.091	2.30
12	.081	2.05
13	.072	1.83
14	.064	1.63
15	.057	1.45
16	.051	1.29
17	.045	1.15
18	.040	1.02
19	.036	.912
20	.032	.812

Gauge	Inches	Millimeters
21	.028	.723
22	.025	.644
23	.023	.573
24	.020	.511
25	.018	.455
26	.016	.405
27	.014	.360
28	.013	.321
29	.011	.286
30	.010	.255
31	.0089	.2266
32	.0080	.2019
33	.0071	.1798
34	.0063	.1600
35	.0056	.1425
36	.0050	.1270
37	.0045	.1130
38	.0040	.1006
40	.0031	.0798

# THE ELASTOMERS

## Natural Rubber

Common Name.....Natural Rubber  
 ASTM D-2000 Classification.....AA  
 Military (MIL-STD 417).....RN  
 Chemical Definition.....Polyisoprene

### General Characteristics

Durometer Range (Shore A).....20-100  
 Tensile Range (P.S.I.).....500-3500  
 Elongation(Max % ).....700  
 Compression Set.....Excellent  
 Resilience - Rebound.....Excellent  
 Abrasion Resistance.....Excellent  
 Tear Resistance.....Excellent  
 Solvent Resistance.....Poor  
 Oil Resistance.....Poor  
 Low Temperature Usage (°F).....-20° to -60°  
 High Temperature Usage (°F).....to 212°  
 Aging Weather - Sunlight.....Poor  
 Adhesion to Metals.....Excellent

### Comments

Natural Rubber has many good characteristics. It has high resilience, good compression set, and molding properties; very good friction surface, but not a fine smooth surface when ground; high tear strength; low crack growth; usable for ketones and alcohol; and good low temperature properties.

Natural Rubber is not recommended for oil and solvent resistance and ozone attacks it.

## Neoprene

Common Name.....Neoprene®  
 ASTM D-2000 Classification.....BC, BE  
 Military (MIL-STD 417).....SC  
 Chemical Definition.....Polychloroprene

### General Characteristics

Durometer Range (Shore A).....20-95  
 Tensile Range (P.S.I.).....500-3000  
 Elongation (Max % ).....600  
 Compression Set.....Good  
 Resilience - Rebound.....Excellent  
 Abrasion Resistance.....Excellent  
 Tear Resistance.....Good  
 Solvent Resistance.....Fair  
 Oil Resistance.....Fair  
 Low Temperature Usage (°F).....+10° to -50°  
 High Temperature Usage (°F).....to 250°  
 Aging Weather - Sunlight.....Good  
 Adhesion to Metals.....Good to Excellent

## Comments

Neoprene is an all purpose polymer with many desirable characteristics. It has additional plus features: high resilience with low compression set; flame resistant; compounds free of sulphur are easily made; and animal and vegetable oil resistant, generally not affected by moderate chemicals, fats, greases, and many oils and solvents.

Neoprene is generally attacked by strong oxidizing acids, esters, ketones, chlorinated aromatic and nitro hydrocarbons.

## SBR

Common Name.....SBR, GRS  
 ASTM D-2000 Classification.....AA, BA  
 Military (MIL-STD 417).....RS  
 Chemical Definition.....Styrene Butadiene

### General Characteristics

Durometer Range (Shore A).....30-100  
 Tensile Range (P.S.I.).....500-3000  
 Elongation (Max % ).....600  
 Compression Set.....Good  
 Resilience - Rebound.....Good  
 Abrasion Resistance.....Excellent  
 Tear Resistance.....Fair  
 Solvent Resistance.....Poor  
 Oil Resistance.....Poor  
 Low Temperature Usage (°F).....0° to -50°  
 High Temperature Usage (°F).....to 225°  
 Aging Weather - Sunlight.....Poor  
 Adhesion to Metals.....Excellent

### Comments

SBR is a low cost non-oil resistant material. It has good water resistance and resilience up to 70 durometer; compression set becomes poorer with higher durometer; generally satisfactory for most moderate chemicals and wet or dry organic acids.

SBR is not recommended for ozone, strong acids, oils, greases, fats, and most hydrocarbons.



# THE ELASTOMERS

## Butyl

Common Name.....Butyl  
 ASTM D-2000 Classification.....AA, BA  
 Military (MIL-STD 417).....RS  
 Chemical Definition.....Isobutylene Isoprene

### General Characteristics

Durometer Range (Shore A).....40-90  
 Tensile Range (P.S.I.).....500-3000  
 Elongation (Max %).....850  
 Compression Set.....Fair to Good  
 Resilience - Rebound .....Fair  
 Abrasion Resistance.....Fair  
 Tear Resistance.....Good  
 Solvent Resistance.....Poor  
 Oil Resistance.....Poor  
 Low Temperature Usage (°F).....10° to -60°  
 High Temperature Usage (°F).....to 250°  
 Aging Weather – Sunlight.....Excellent  
 Adhesion to Metals.....Good

### Comments

Butyl rubber is impermeable to most common gasses and has good resistance to sunlight and ozone. Butyl is normally satisfactory when exposed to animal and vegetable oils and oxidizing chemicals.

Butyl is not recommended for use with petroleum solvent, coal tar, and aromatic hydrocarbons.

## EPR

Common Name.....EPR, EPT, EPDM  
 ASTM D-2000 Classification.....CA  
 Military (MIL-STD 417).....RS  
 Chemical Definition.....Ethylene Propylene

### General Characteristics

Durometer Range (Shore A).....30-90  
 Tensile Range (P.S.I.).....500-2500  
 Elongation (Max %).....600  
 Compression Set.....Good  
 Resilience - Rebound.....Good  
 Abrasion Resistance.....Good  
 Tear Resistance.....Fair  
 Solvent Resistance.....Poor  
 Oil Resistance.....Poor  
 Low Temperature Usage (°F).....20° to -60°  
 High Temperature Usage (°F).....to 350°  
 Aging Weather - Sunlight.....Excellent  
 Adhesion to Metals.....Fair to Good

### Comments

Ethylene Propylene is a polymer with outstanding properties. It has exceptionally good weather aging and ozone resistance; excellent water and chemical resistance; excellent resistance to gas permeability, and excellent resistance to aging due to exposure to steam; and heat, resistance excellent up to 350°F. Ethylene Propylene is a polymer where oil and solvent resistance is poor, however, it is fairly good in ketones and alcohols. It is not recommended for food applications or exposure to aromatic hydrocarbons.

## Buna-N

Common Name.....Buna N, Nitrile, NBR  
 ASTM D-2000 Classification.....BF, BG, BK  
 Military (MIL-STD 417).....SB  
 Chemical Definition.....Butadiene Acrylonitrile

### General Characteristics

Durometer Range (Shore A).....20-95  
 Tensile Range (P.S.I.).....200-3000  
 Elongation (Max %).....600  
 Compression Set.....Good  
 Resilience - Rebound.....Good  
 Abrasion Resistance.....Excellent  
 Tear Resistance.....Good  
 Solvent Resistance.....Good to Excellent  
 Oil Resistance.....Good to Excellent  
 Low Temperature Usage (°F).....+30° to -40°  
 High Temperature Usage (°F).....to 250°  
 Aging Weather - Sunlight.....Poor  
 Adhesion to Metals.....Good to Excellent

### Comments

Nitrile (Buna-N) is a general purpose oil resistant polymer which has good solvent, oil, water, and hydraulic fluid resistance, good compression set, abrasion resistance and tensile strength. Nitrile should not be used in highly polar solvents such as acetone, and MEK, ozone, chlorinated hydrocarbons, and nitro hydrocarbons.

# THE ELASTOMERS

## Silicone

Common Name.....Silicone  
 ASTM D-2000 Classification.....FC, FE, GE  
 Military (MIL-STD 417).....TA  
 Chemical Definition.....Polysiloxane

### General Characteristics

Durometer Range (Shore A).....30-90  
 Tensile Range (P.S.I.).....200-1500  
 Elongation (Max %).....700  
 Compression Set.....Good  
 Resilience - Rebound.....Good  
 Abrasion Resistance.....Fair to Poor  
 Tear Resistance.....Poor  
 Solvent Resistance.....Poor  
 Oil Resistance.....Fair to Poor  
 Low Temperature Usage (°F).....60° to 150°  
 High Temperature Usage (°F).....to 450°  
 Aging Weather - Sunlight.....Excellent  
 Adhesion to Metals.....Good

## Comments

Silicone Rubber has a great many variations and can be compounded to meet any number of applications, Silicone can be compounded to have tensile in the area of 1500 PSI and tear up to 200 lbs.; low compression set and good resilience; moderate solvent resistance; excellent heat resistance; good release characteristics; extreme low temperature properties; and can be highly resistant to oxidation and ozone attack.

Silicone is generally attacked by most concentrated solvents, oils, concentrated acids, and diluted sodium hydroxide.

# STANDARD TOLERANCES FOR MOLDED PARTS

Standard Dimensional Tolerance Table - Molded Solid Rubber Products  
 Drawing Designation "A3" Commercial

Size (inches) Above-Incl.	Fixed	Closure	Size (Millimeters) Above-Incl.	Fixed	Closure
0-.40	±.008	±.013	0-10	±.20	±.32
.40-.63	.010	.016	10-16	.25	.40
.63-1.00	.013	.020	16-25	.32	.50
1.00-1.60	.016	.025	25-40	.40	.63
1.60-2.50	.020	.032	40-63	.50	.80
2.50-4.00	.025	.040	63-100	.63	1.00
4.00-6.30	.032	.050	100-160	.80	1.25
6.30 & over -	To find fixed dimensional tolerances multiply by 0.5%.		160 & over -	To find fixed dimensional tolerances multiply by 0.5%.	

### Note:

1. Fixed dimension tolerances apply individually to each fixed dimension by its own size.
2. Closure dimension tolerances are determined by the largest closure dimension and this single tolerance is used for all other closure dimensions.

Drawing Designation "A3" tolerances indicate a "commercial" product and will normally be used for most products.

# THE GENERAL CHEMICAL RESISTANCE OF VARIOUS RUBBERS & PLASTICS

Chemical	Key												
	(S) Satisfactory	(U) Unsatisfactory	(-) Unknown	Natural Rubber	S.B.R	Neoprene	Buna N	Viton	Hypalon	E.P.T	Butyl	Polyethylene	Teflon
Acetic Acid - Dilute.....	U	U	U	U	U	U	U	S	S	S	S	S	S
- 30%.....	U	U	U	U	U	U	U	S	U	S	S	S	S
- Glacial.....	U	U	U	U	U	U	U	S	U	S	S	S	S
Acetone.....	U	S	U	U	U	U	U	S	S	S	S	S	S
Acrolein.....	U	U	-	-	-	-	-	-	-	-	-	-	S
Allyl Alcohol.....	S	S	S	S	S	S	S	S	S	S	S	S	S
Allyl Chloride.....	U	-	U	U	-	U	-	-	-	-	S	S	S
Alum.....	S	S	S	S	S	S	S	S	S	S	S	S	S
Ammonia Anhydrous.....	S	S	S	U	U	U	U	S	S	S	S	S	S
Ammonium Hydroxide.....	U	U	U	U	U	S	S	S	S	S	S	S	S
Ammonium Nitrate.....	S	S	S	S	S	S	S	S	S	S	S	S	S
Aniline.....	U	U	U	U	U	S	S	S	S	S	S	S	S
Asphalt.....	U	U	S	S	-	U	U	U	S	S	S	S	S
Benzene.....	U	U	U	U	S	U	U	U	S	S	S	S	S
Butyl Acetate.....	U	U	U	U	U	U	U	S	S	S	S	S	S
Butyl Carbitol.....	S	S	S	S	S	S	S	S	S	S	S	S	S
Butyl Cellosolve.....	U	U	S	S	S	S	S	S	S	S	S	S	S
Calcium Chloride.....	U	U	S	S	S	S	S	S	S	S	S	S	S
Carbital.....	S	S	S	S	S	S	S	S	S	S	S	S	S
Carbon Tetrachloride.....	U	U	S	S	-	-	S	S	-	S	-	S	-
Cellosolve.....	U	U	U	U	S	U	U	U	S	S	S	S	S
Cellosolve Acetate.....	U	U	S	S	-	S	S	S	S	S	S	S	S
Corn Syrup.....	U	U	U	U	U	U	-	-	-	-	S	S	S
Cyclehexanone.....	U	U	U	S	S	U	U	S	S	S	S	S	S
Di-Acetone Alcohol.....	U	U	U	-	U	-	U	S	S	S	S	S	S
Di-Ison Butyl Ketone.....	U	U	S	U	U	S	S	S	S	S	S	S	S
Di-Isopropyl Ether.....	U	U	U	U	U	U	U	S	S	S	S	S	S
Di-Octyl Phthalate.....	U	U	U	S	U	U	-	-	-	-	-	-	-
Epichlorohydrin.....	U	U	U	-	U	S	S	S	S	S	S	S	S
Ethyl Acetate.....	U	-	U	U	-	U	-	-	-	-	S	S	S
Ethyl Alcohol.....	U	U	U	U	U	U	U	S	S	S	S	S	S
Ethyl Amyl Ketone.....	S	S	S	S	S	S	S	S	S	S	S	S	S
Ethyl Chloride.....	U	U	U	U	-	S	U	S	S	S	S	S	S
2-Ethyl Hexanol.....	S	S	S	S	S	S	U	S	S	S	S	S	S
Ethylene Glycol.....	U	-	U	U	-	U	-	-	-	-	S	S	S
Formaldehyde.....	S	S	S	S	S	S	S	S	S	S	S	S	S
Freon 12.....	U	S	U	U	S	S	S	S	S	S	S	S	S
Freon 13.....	S	U	S	S	S	S	S	S	S	S	S	S	S
Freon 21.....	U	U	S	S	U	U	S	S	S	S	S	S	S
Freon 22.....	U	U	S	S	U	U	U	S	S	S	S	S	S
Gasoline.....	U	U	S	S	U	U	U	S	S	S	S	S	S
Glycerine.....	S	S	S	S	S	S	S	S	S	S	S	S	S
Grease.....	U	U	S	S	S	S	U	S	S	S	S	S	S
Hexane.....	U	U	S	S	S	S	U	U	S	S	S	S	S
Hexylene Glycol.....	S	S	S	S	S	S	-	S	S	S	S	S	S
Hydrochloric Acid -10%....	S	U	U	U	S	S	S	S	S	S	S	S	S
- 38%....	U	U	U	U	S	S	S	S	S	S	S	S	S
Isophorone.....	U	U	U	U	-	-	-	-	-	-	-	-	S

Chemical	Key												
	(S) Satisfactory	(U) Unsatisfactory	(-) Unknown	Natural Rubber	S.B.R	Neoprene	Buna N	Viton	Hypalon	E.P.T	Butyl	Polyethylene	Teflon
Jet Fuel (JP-1 to JP-5).....	U	U	S	S	S	U	U	U	S	S	S	S	S
Kerosene.....	U	U	S	S	S	U	U	U	S	S	S	S	S
Mesital Oxide.....	U	U	U	-	-	-	-	-	-	-	-	-	-
Methyl Alcohol.....	S	S	S	S	S	S	S	S	S	S	S	S	S
Methyl Amyl Acetate.....	U	U	U	U	U	U	-	-	-	-	S	S	S
Methyl Cellosolve.....	U	U	S	-	-	-	-	-	-	-	S	-	S
Methyl Ethyl Ketone.....	U	U	U	U	U	S	U	S	U	S	S	S	S
Methyl Isobutyl Carbinol.....	S	S	S	S	S	S	S	S	S	S	S	S	S
Methyl Isobutyl Ketone.....	U	U	U	U	U	S	U	S	U	S	S	S	S
Methyl Methacrylate.....	U	U	U	U	S	U	U	S	U	S	S	S	S
Mehtylene Chloride.....	U	U	U	U	S	U	U	-	S	S	S	S	S
Milk.....	U	S	S	S	U	S	-	S	S	-	S	S	S
Molasses.....	S	U	S	U	U	U	U	S	S	S	S	S	S
Monochlorobenzene.....	U	U	U	S	U	U	U	S	S	S	S	S	S
Naptha.....	U	U	U	S	S	U	U	U	S	S	S	S	S
Nitric Acid - 10%.....	U	U	S	U	U	S	S	S	S	S	S	S	S
- 70%.....	U	U	U	U	U	S	U	U	S	S	S	S	S
- Fuming..	U	U	U	U	U	U	U	U	S	S	S	S	S
Oil, Crude.....	U	U	S	S	S	S	U	U	S	S	S	S	S
Oil, Lubricating.....	U	U	S	S	S	S	U	U	S	S	S	S	S
Oil, Vegetable.....	U	U	S	S	S	S	U	U	S	S	S	S	S
Oleic Acid.....	U	U	S	-	U	S	S	S	S	S	S	S	S
Palmitic Acid.....	U	U	S	U	U	-	-	-	-	-	S	S	S
Phenol.....	U	U	-	U	S	-	-	-	-	-	U	S	S
Phosphoric Acid - 50%....	S	S	S	S	S	S	S	S	S	S	S	S	S
- 80%....	S	S	S	S	S	S	S	S	S	S	S	S	S
Propane Gas, Liquid.....	U	U	S	U	U	U	U	S	S	S	S	S	S
Propyl Acetate.....	U	U	U	U	U	U	U	S	S	S	S	S	S
Propyl Alcohol.....	S	S	S	S	S	S	S	S	S	S	S	S	S
Propylene Glycol.....	-	-	-	-	-	-	-	-	-	-	S	S	S
Sodium Hydroxide.....	U	U	U	U	U	U	S	S	S	S	S	S	S
Sodium Silicate.....	S	S	S	S	S	S	S	S	S	S	S	S	S
Stearic Acid.....	U	U	S	-	S	-	-	-	-	-	S	S	S
Styrene.....	U	U	U	S	U	U	U	-	-	-	-	-	-
Sulfur.....	U	U	S	U	S	S	U	U	U	S	S	S	S
Sulfur, Molten.....	U	U	U	U	U	U	U	U	U	S	S	S	S
Sulfuric Acid - 10%.....	S	S	S	S	S	S	S	S	S	S	S	S	S
- 70%.....	U	U	U	U	U	S	S	S	S	S	S	S	S
- Fuming..	U	U	U	U	S	U	U	S	S	S	S	S	S
Tall Oil.....	U	U	S	S	S	U	U	U	S	S	S	S	S
Tallow.....	U	U	S	S	S	S	U	U	S	S	S	S	S
Tar.....	U	U	S	-	S	U	U	U	S	S	S	S	S
Toluene.....	U	U	U	U	S	U	U	U	S	S	S	S	S
Trichloroethane.....	-	-	-	-	-	-	-	-	-	-	-	-	-
Trichloroethylene.....	U	U	U	U	S	U	U	U	S	S	S	S	S
Urea.....	S	S	S	S	S	S	-	-	-	-	S	S	S
Wax.....	U	U	S	S	S	S	U	U	S	S	S	S	S
Xylo.....	U	U	U	S	U	U	U	S	S	S	S	S	S

## RUBBER PROCESSING

The primary methods for processing raw compound into cured rubber parts are compression molding, transfer molding, injection and extrusion.

These techniques are used to produce a broad range of parts, such as gaskets, grommets, sleeves, O-rings, rollers, bellows, boots, diaphragms, tape, tubing and profiles, to name a few.

The type of processing technique selected to produce a particular part is influenced by the complexity and specifications for the part, material requirements, allowable part tolerances, the number of parts to be molded and economics. Generally, as a part moves from compression to transfer molding, the cost of tooling goes up, piece price goes down, and tolerances are enhanced.

It is important to note that tolerances are more difficult to hold in molds with a large number of cavities. This is because for all molding methods, the molding pressure on a cavity varies depending on where the cavity is located. Therefore, if quality requirements are high, the number of cavities per mold may be low. ESTCO works closely with customers to determine the optimum balance between acceptable tolerances, piece part costs and tooling costs.

## COMPRESSION MOLDING

Compression molding is often selected for low-volume runs because the tooling is relatively easy and inexpensive to produce. It also may be the best choice for extremely large parts with only one or two cavities per mold. However, loading and demolding, often done by hand, makes compression molding labor intensive.

In compression molding, a preform (a shaped piece of uncured rubber) is placed in one half of a heated mold (Top View). Generally, one preform is needed for each cavity. The mold is closed and pressure applied via a press, forcing the rubber to spread throughout the cavity. Excess rubber, called flash, flows into an overflow groove surrounding the cavity. (Note: Flash is stripped off the final part, but molds need to be designed to allow for its occurrence.)

Parts commonly produced by compression molding are O-rings, gaskets, seals, diaphragms, bumpers and umbrella valves.

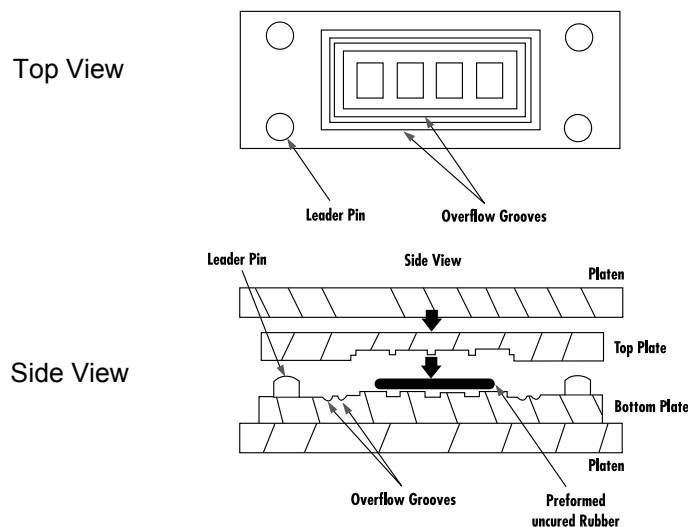

# TRANSFER MOLDING

Transfer molding is one of the most popular molding methods. It is used when a medium to high volume of parts need to be produced, when tighter tolerances are required, when parts are more complicated, or when molding around pins and inserts.

In “pot and piston” transfer molding (Side View), a single preform is loaded into a transfer pot. A piston then forces the rubber directly through the sprues (portals), filling the cavities. The cured portion of the rubber remaining in the transfer pot, called a flash pad or cull, is then disposed of. This type of system tends to be used with larger tooling to achieve more consistent pressures across the cavity plate, producing more consistent parts.

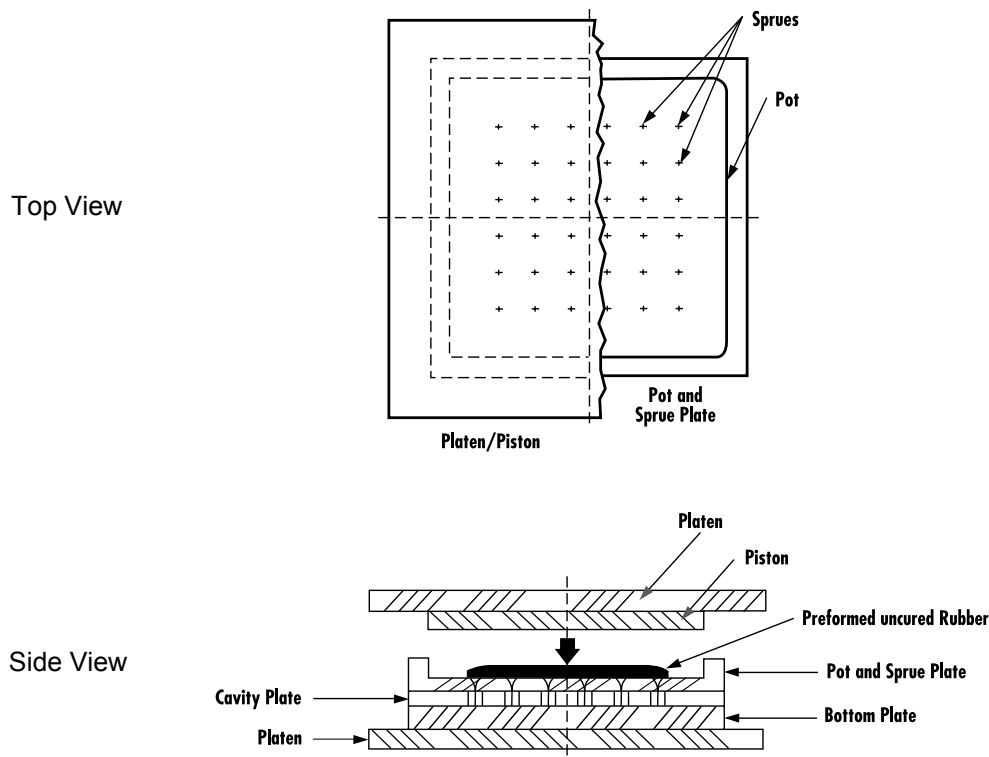

Smaller tooling can sometimes benefit by using the “runner system” of transfer molding. Here, a piston forces the rubber through a runner (flow groove) and through a sprue to fill the cavities.

Because the mold is clamped shut before the material enters the cavities, flash can be minimized.

Transfer molding (both types) can produce more parts per hour than compression molding because many cavities can be filled with one (or a few) preforms, cure times can be faster, and the process can be partially automated. Piece part costs will be lower, but it requires additional tooling.

Parts commonly produced by transfer molding are rollers, grommets, bumpers, bellows, small O-rings, gaskets, sleeves and diaphragms. Compared to compression molding, transfer molding can provide tighter tolerances because little to no allowance is required for closure dimensions.

## INJECTION MOLDING

Injection molding is a manufacturing process for producing parts by injecting material into a mold. Injection molding can be performed with a host of materials, including metals, glasses, elastomers, confections, and most commonly thermoplastic and thermosetting polymers. Material for the part is fed into a heated barrel, mixed, and forced into a mold cavity, where it cools and hardens to the configuration of the cavity. [1]:240 After a product is designed, usually by an industrial designer or an engineer, molds are made by a mouldmaker (or toolmaker) from metal, usually either steel or aluminum, and precision-machined to form the features of the desired part. Injection molding is widely used for manufacturing a variety of parts, from the smallest components to entire body panels of cars. Advances in 3D printing technology, using photopolymers which do not melt during the injection moulding of some lower temperature thermoplastics, can be used for some simple injection moulds.

Parts to be injection moulded must be very carefully designed to facilitate the moulding process; the material used for the part, the desired shape and features of the part, the material of the mould, and the properties of the moulding machine must all be taken into account. The versatility of injection moulding is facilitated by this breadth of design considerations and possibilities.

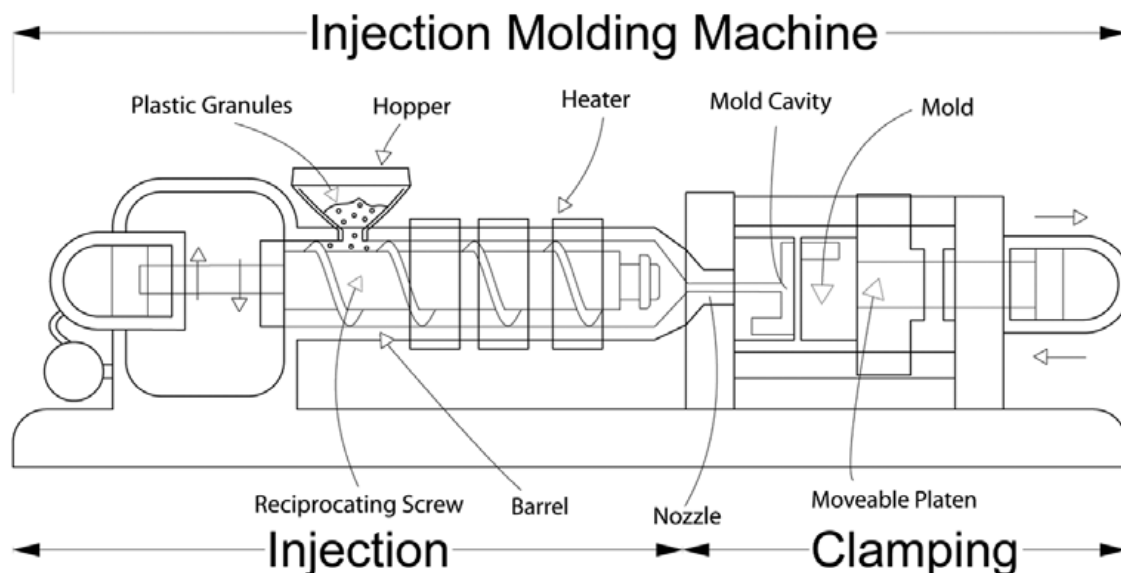

## EXTRUSION DESIGN VARIABLES

Fabricating extruded parts has been called more of an art form than a science. Because of the swell and flow characteristics of elastomeric materials, the orifice of the die is rarely identical to the cross section. Materials with different properties will have different swell and flow characteristics. A die that produces one shape with 20 durometer material will produce a different shape with a 30 durometer material. Each durometer change and material change necessitates a new die because of the differing flow characteristics.

Because of rubber's flow characteristics,  
the orifice of the die is rarely identical to the part's cross section.

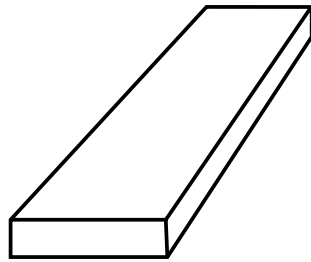

**Rectangular Finished Part**

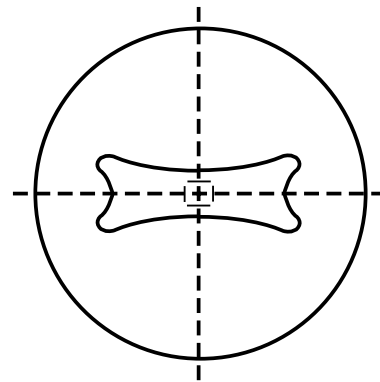

**"Smile" Die Pattern to make finished part**

Uncured rubber extrusions have a poor "green strength". This means the extrusion will have a tendency to sag and flatten, depending on: the hardness or softness of the compound, the tensile strength or quality of the compound, thickness or thinness of the cross sectional wall, the inner diameter of the extrusion and the rate of extrusion.

## TABLE OF CONTENTS

---



### **SECTION 01** **BUMPERS**

- ⚙ CONICAL ADHESIVE BACKED BUMPERS
- ⚙ HEMISPHERICAL ADHESIVE BACKED BUMPERS
- ⚙ RECESSED ADHESIVE BACKED BUMPERS
- ⚙ CYLINDRICAL ADHESIVE BACKED BUMPERS



### **SECTION 02** **GROMMETS**

- ⚙ GROMMETS
- ⚙ ARMY-NAVY APPROVED AN931 GROMMETS



### **SECTION 03** **RUBBER FEET**

- ⚙ RECTANGULAR THERMOPLASTIC RUBBER FEET
  - ⚙ ROUND POLYETHYLENE (PE) FEET
  - ⚙ CABLE STRAPS
  - ⚙ COLLAPSIBLE TILT STANDS
- AND MORE!**



### **SECTION 04** **SEAL, PLUG, & FLASH MASTER**

- ⚙ SEAL IN / SEAL OUT WASHERS
  - ⚙ PLUG MASTER- FASTENING, SEALING, CUSHIONING SYSTEM
  - ⚙ STANDARD FLASH MASTER
  - ⚙ MULTI-PORIT FLASH MASTER
- AND MORE!**





## **SECTION 05** **SELF-FUSING TAPES**

- ⚙ ESTCO'S ORIGINAL FUSEIT™ TAPE
- ⚙ SFT - SILICONE, SELF-FUSING ELECTRICAL TAPE
- ⚙ SELF-FUSING SILICONE TAPE

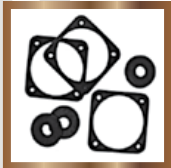

## **SECTION 06** **SPECIALTY & MISC. ITEMS**

- ⚙ SUNSCREENER WIRE MESH CLIP
  - ⚙ LATEX FREE DIAPHRAGMS
  - ⚙ EXTRUSIONS & LATHE CUTS
  - ⚙ WELL NUT® METRIC THREADED INSERTS
- AND MORE!**



## **SECTION 07** **VIBRATION & SHOCK MOUNTS**

- ⚙ SERIES 300 CYLINDRICAL MOUNTINGS
  - ⚙ SERIES 540 RECTANGULAR MOUNTINGS
  - ⚙ SERIES 1000 CUSTOM MOLDED MOUNTING FEET
  - ⚙ SERIES 5000 BONDED BUSHING AND SNUBBER
- AND MORE!**



## **SECTION 08** **WIRE PROTECTION & POWER COMPONENTS**

- ⚙ CABLE TIES
  - ⚙ NYLON CABLE CLAMPS
  - ⚙ PUSH MOUNT WIRE CLIPS
  - ⚙ LOCKIT HOSE CLAMPS
- AND MORE!**



## **SECTION 09** **SAFETY GEAR & GLOVES**

- ⚙ APPAREL & HI-VIZ WEAR
  - ⚙ HEARING PROTECTION
  - ⚙ HAZARDOUS STORAGE
  - ⚙ LATEX FREE DISPOSABLE GLOVES
- AND MORE!**

# BUMPERS

## CONICAL ADHESIVE BACKED BUMPERS



BS-37 (BOX)



BS-34 (BOX)

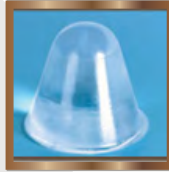

BS-57 (BOX)

## CYLINDRICAL ADHESIVE BACKED BUMPERS



BS-01 (BOX)



BS-05 (BOX)



BS-06 (BOX)



BS-11 (BOX)



BS-24 (BOX)

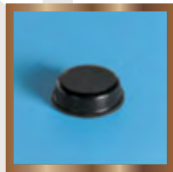

BS-34 (BOX)

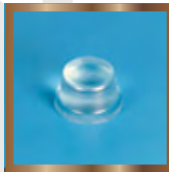

BS-35 (BOX)



BS-41 (BOX)



BS-44 (BOX)

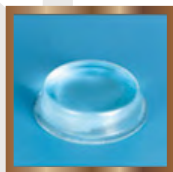

BS-45 (BOX)



BS-72 (BOX)

# BUMPERS CONTINUED

## HEMISPHERICAL ADHESIVE BACKED BUMPERS

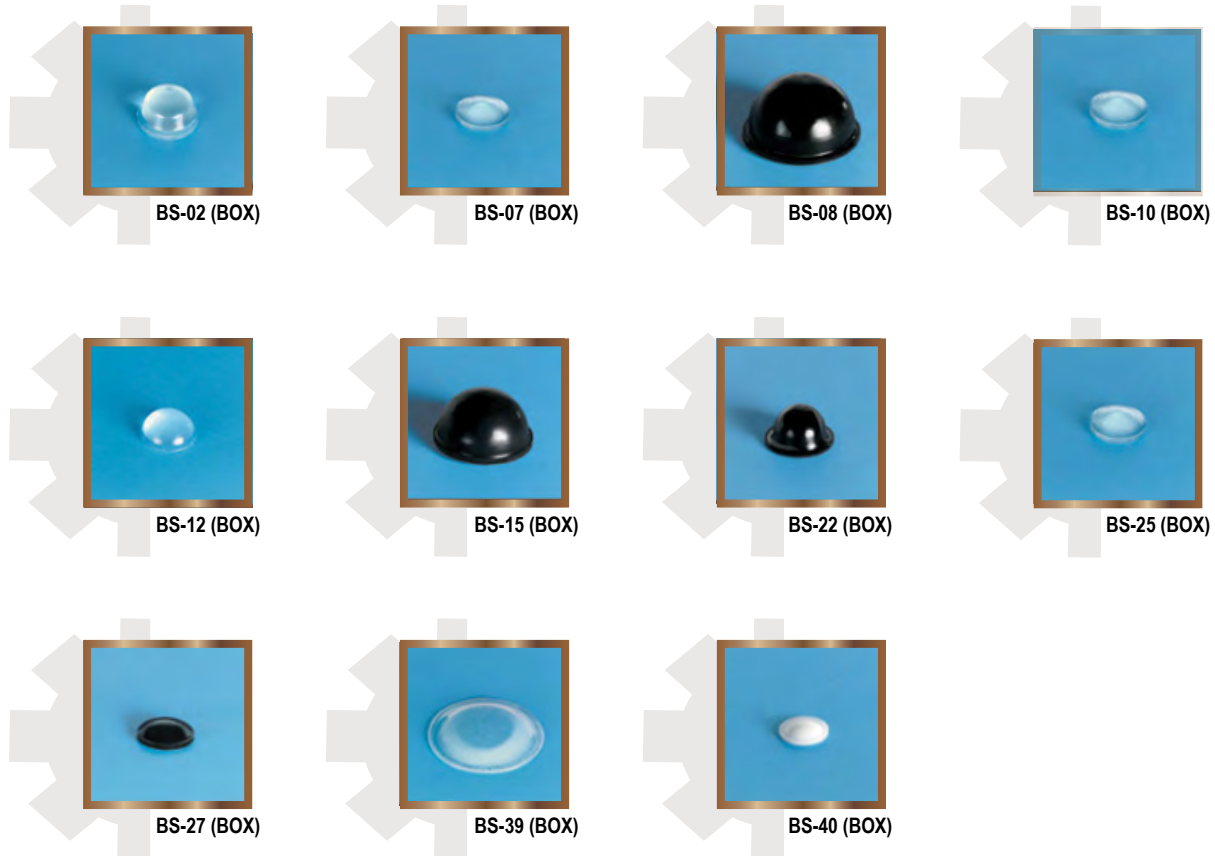

## RECESSED ADHESIVE BACKED BUMPERS



**CONICAL**

Product color options available in Clear, Black, White, Brown, and Grey



ISO 9001 Certified  
CERTIFICATE # 08-511



**QS-BS-37** Cone Shaped Polyurethane Bumpers

Cone shaped profiles have a rounded point at the tip. They are our tallest bumpers available for applications that require extra height. Peel and stick.

Diameter (inches) .720"  
Height (inches) .560"

Diameter (metric) 18.3mm  
Height (metric) 14.2mm

Bumpers per Sheet 1  
Bumpers per Box 1,500

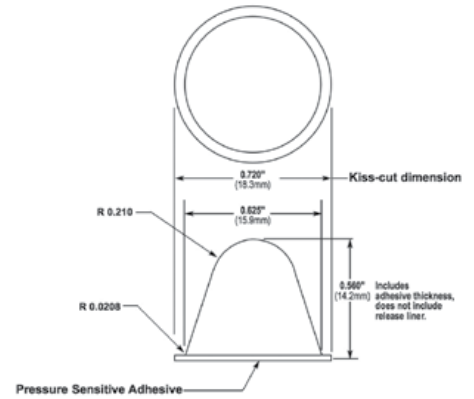

**QS-BS-47** Cone Shaped Polyurethane Bumpers

Cone shaped profiles have a rounded point at the tip. They are our tallest bumpers available for applications that require extra height. Peel and stick.

Diameter (inches) .750"  
Height (inches) .750"

Diameter (metric) 19.1mm  
Height (metric) 19.1mm

Bumpers per Sheet 1  
Bumpers per Box 1,000

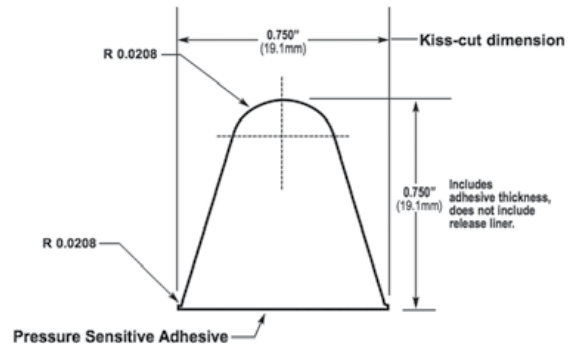

**QS-BS-57** Cone Shaped Polyurethane Bumpers

Cone shaped profiles have a rounded point at the tip. They are our tallest bumpers available for applications that require extra height. Peel and stick.

Diameter (inches) .787"  
Height (inches) .886"

Diameter (metric) 20.0mm  
Height (metric) 22.5mm

Bumpers per Sheet 1  
Bumpers per Box 1,000

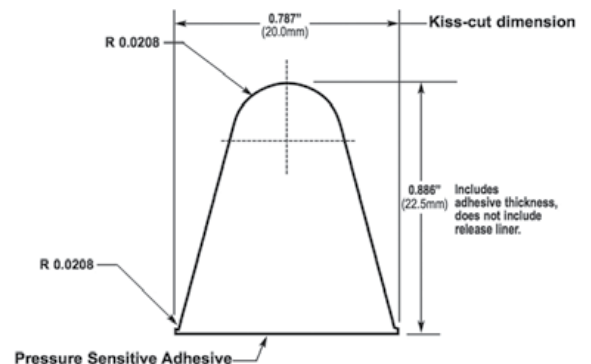

# CYLINDRICAL

Product color options available in Clear, Black, White, Brown, and Grey



ISO 9001 Certified  
CERTIFICATE # 08-511



## QS-BS-01 Flat Top Polyurethane Bumpers

These profiles are circular Bumpers with flat tops. The design utilizes the flat contact area for many varied applications; also, can be used in a recessed cavity for anti-skid applications

Diameter (inches) .500"  
Height (inches) .140"

Diameter (metric) 12.7mm  
Height (metric) 3.5mm

Bumpers per Sheet 200  
Sheets per Box 25  
Bumpers per Box 5,000

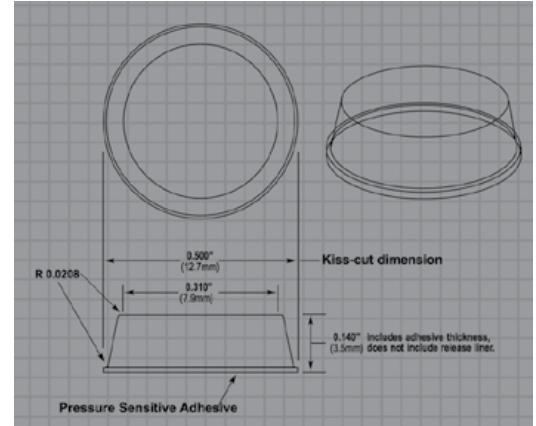

## QS-BS-05 Flat Top Polyurethane Bumpers

These profiles are circular Bumpers with flat tops. The design utilizes the flat contact area for many varied applications; also, can be used in a recessed cavity for anti-skid applications

Diameter (inches) .500"  
Height (inches) .060"

Diameter (metric) 12.7mm  
Height (metric) 1.5mm

Bumpers per Sheet 200  
Sheets per Box 25  
Bumpers per Box 5,000

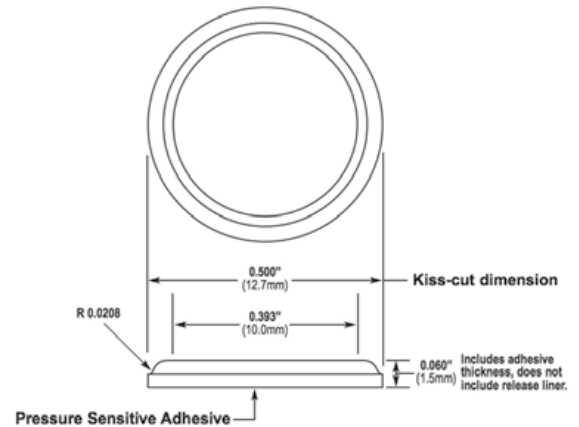

## QS-BS-06 Flat Top Polyurethane Bumpers

These profiles are circular Bumpers with flat tops. The design utilizes the flat contact area for many varied applications; also, can be used in a recessed cavity for anti-skid applications

Diameter (inches) .500"  
Height (inches) .250"

Diameter (metric) 12.7mm  
Height (metric) 6.4mm

Bumpers per Sheet 200  
Sheets per Box 25  
Bumpers per Box 5,000

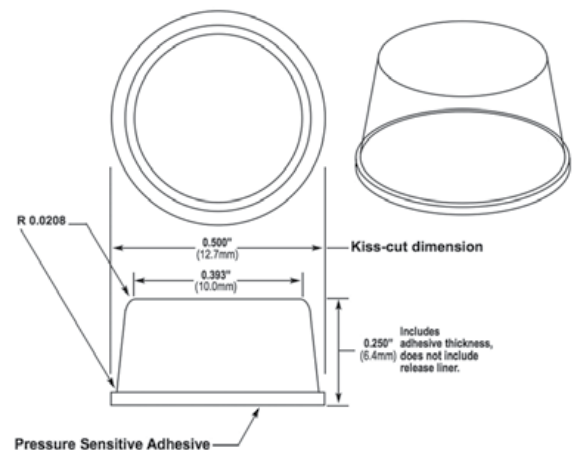

**CYLINDRICAL**

Product color options available in Clear, Black, White, Brown, and Grey



ISO 9001 Certified  
CERTIFICATE # 08-511



**QS-BS-11** Flat Top Polyurethane Bumpers

These profiles are circular Bumpers with flat tops. The design utilizes the flat contact area for many varied applications; also, can be used in a recessed cavity for anti-skid applications

Diameter (inches) .650"  
Height (inches) .400"

Diameter (metric) 16.5mm  
Height (metric) 10.2mm

Bumpers per Sheet 128  
Sheets per Box 20  
Bumpers per Box 2,560

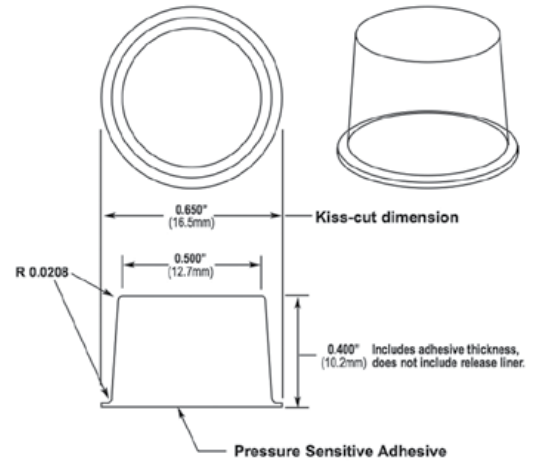

**QS-BS-24** Flat Top Polyurethane Bumpers

These profiles are circular Bumpers with flat tops. The design utilizes the flat contact area for many varied applications; also, can be used in a recessed cavity for anti-skid applications

Diameter (inches) .810"  
Height (inches) .120"

Diameter (metric) 20.6mm  
Height (metric) 3.0mm

Bumpers per Sheet 72  
Sheets per Box 35  
Bumpers per Box 2,520

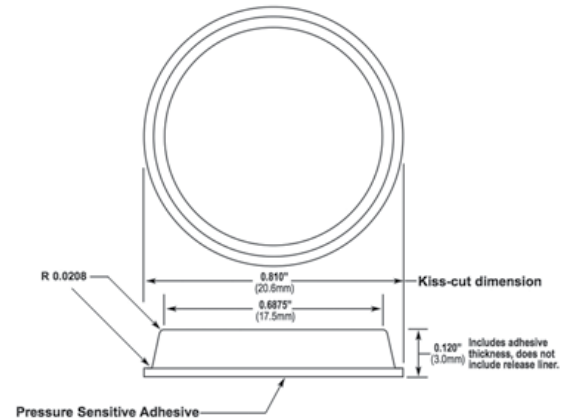

**QS-BS-34** Flat Top Polyurethane Bumpers

These profiles are circular Bumpers with flat tops. The design utilizes the flat contact area for many varied applications; also, can be used in a recessed cavity for anti-skid applications

Diameter (inches) .375"  
Height (inches) .125"

Diameter (metric) 9.5mm  
Height (metric) 3.2mm

Bumpers per Sheet 300  
Sheets per Box 20  
Bumpers per Box 6,000

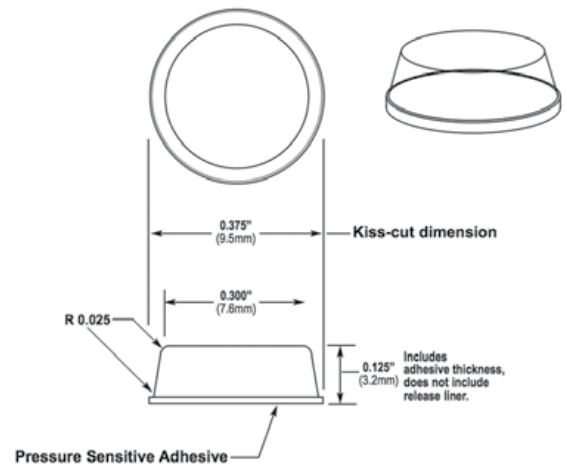

# CYLINDRICAL

Product color options available in Clear, Black, White, Brown, and Grey



ISO 9001 Certified  
CERTIFICATE # 08-511



## QS-BS-35 Flat Top Polyurethane Bumpers

These profiles are circular Bumpers with flat tops. The design utilizes the flat contact area for many varied applications; also, can be used in a recessed cavity for anti-skid applications

Diameter (inches) .375"  
Height (inches) .190"

Diameter (metric) 9.5mm  
Height (metric) 4.8mm

Bumpers per Sheet 200  
Sheets per Box 25  
Bumpers per Box 5,000

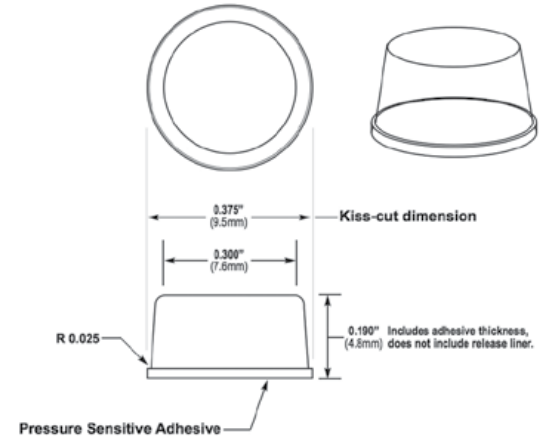

## QS-BS-41 Flat Top Polyurethane Bumpers

These profiles are circular Bumpers with flat tops. The design utilizes the flat contact area for many varied applications; also, can be used in a recessed cavity for anti-skid applications

Diameter (inches) .780"  
Height (inches) .200"

Diameter (metric) 19.8mm  
Height (metric) 5.1mm

Bumpers per Sheet 84  
Sheets per Box 40  
Bumpers per Box 3,360

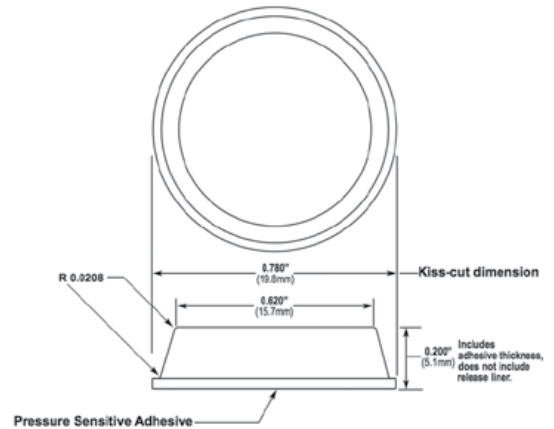

## QS-BS-44 Flat Top Polyurethane Bumpers

These profiles are circular Bumpers with flat tops. The design utilizes the flat contact area for many varied applications; also, can be used in a recessed cavity for anti-skid applications

Diameter (inches) .750"  
Height (inches) .160"

Diameter (metric) 19.1mm  
Height (metric) 4.1mm

Bumpers per Sheet 98  
Sheets per Box 25  
Bumpers per Box 2,450

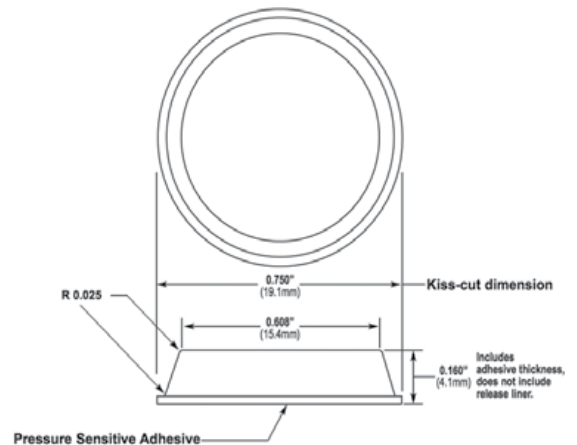

# CYLINDRICAL

Product color options available in Clear, Black, White, Brown, and Grey



ISO 9001 Certified  
CERTIFICATE # 08-511



## QS-BS-45 Flat Top Polyurethane Bumpers

These profiles are circular Bumpers with flat tops. The design utilizes the flat contact area for many varied applications; also, can be used in a recessed cavity for anti-skid applications

Diameter (inches) .710"  
Height (inches) .180"

Diameter (metric) 18.00 mm  
Height (metric) 4.60mm

Bumpers per Sheet 98  
Sheets per Box 25  
Bumpers per Box 2,450

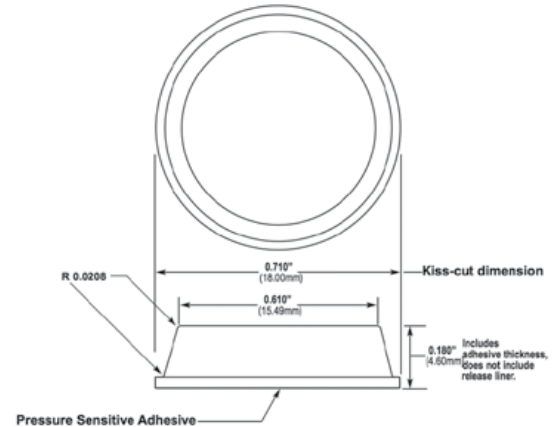

## QS-BS-72 Flat Top Polyurethane Bumpers

These profiles are circular Bumpers with flat tops. The design utilizes the flat contact area for many varied applications; also, can be used in a recessed cavity for anti-skid applications

Diameter (inches) 1.230"  
Height (inches) .100"

Diameter (metric) 31.24mm  
Height (metric) 2.54mm

Bumpers per Sheet 32  
Sheets per Box 75  
Bumpers per Box 2,400

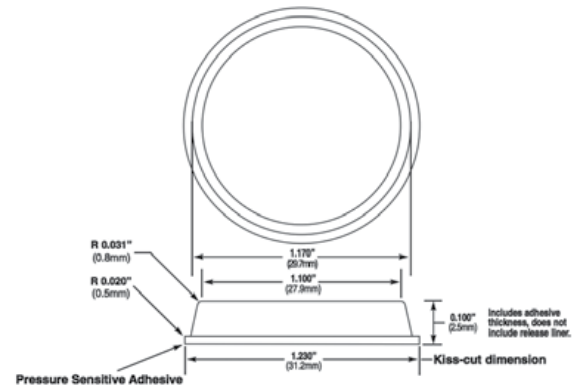



# HEMISPHERICAL

Product color options available in Clear, Black, White, Brown, and Grey



ISO 9001 Certified  
CERTIFICATE # 08-511



## QS-BS-02 Rounded Top Polyurethane Bumpers

These parts are rounded on top and have a dome shape that absorbs impact and are ideal to prevent skidding. This category includes our smallest profiles.

Diameter (inches) .440"  
Height (inches) .200"

Diameter (metric) 11.1mm  
Height (metric) 5.1mm

Bumpers per Sheet 242  
Sheets per Box 21  
Bumpers per Box 5,082

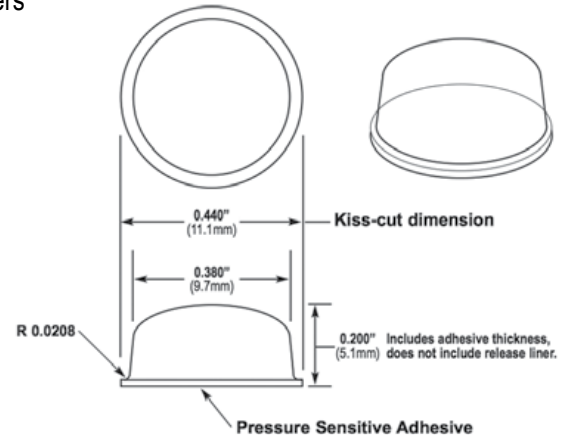

## QS-BS-07 Rounded Top Polyurethane Bumpers

These parts are rounded on top and have a dome shape that absorbs impact and are ideal to prevent skidding. This category includes our smallest profiles.

Diameter (inches) .335"  
Height (inches) .085"

Diameter (metric) 8.5mm  
Height (metric) 2.2mm

Bumpers per Sheet 450  
Sheets per Box 12  
Bumpers per Box 5,400

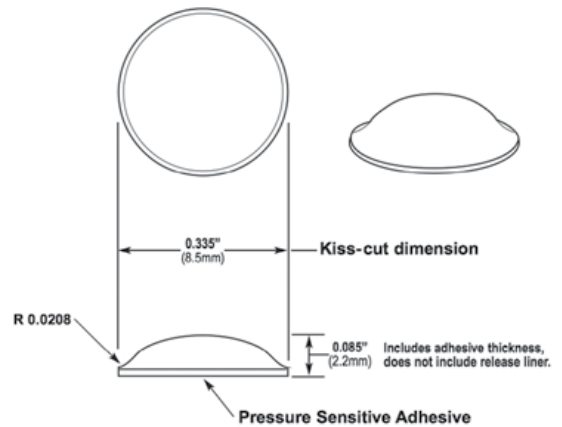

## QS-BS-08 Rounded Top Polyurethane Bumpers

These parts are rounded on top and have a dome shape that absorbs impact and are ideal to prevent skidding. This category includes our smallest profiles.

Diameter (inches) .700"  
Height (inches) .380"

Diameter (metric) 17.8mm  
Height (metric) 9.6mm

Bumpers per Sheet 98  
Sheets per Box 23  
Bumpers per Box 2,254

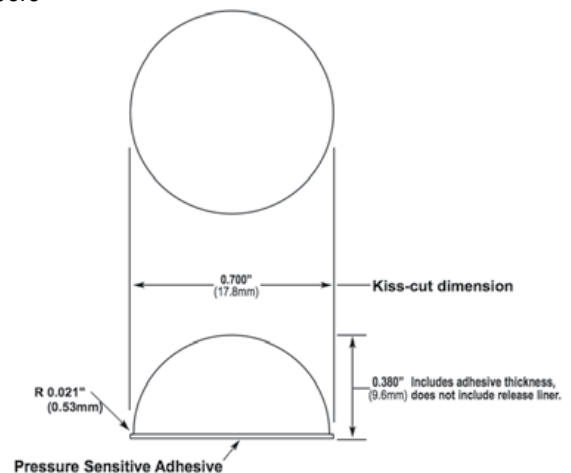

# HEMISPHERICAL

Product color options available in Clear, Black, White, Brown, and Grey



ISO 9001 Certified  
CERTIFICATE # 08-511



## QS-BS-10 Rounded Top Polyurethane Bumpers

These parts are rounded on top and have a dome shape that absorbs impact and are ideal to prevent skidding. This category includes our smallest profiles.

Diameter (inches) .394"  
Height (inches) .118"

Diameter (metric) 10mm  
Height (metric) 3mm

Bumpers per Sheet 288  
Sheets per Box 25  
Bumpers per Box 7,200

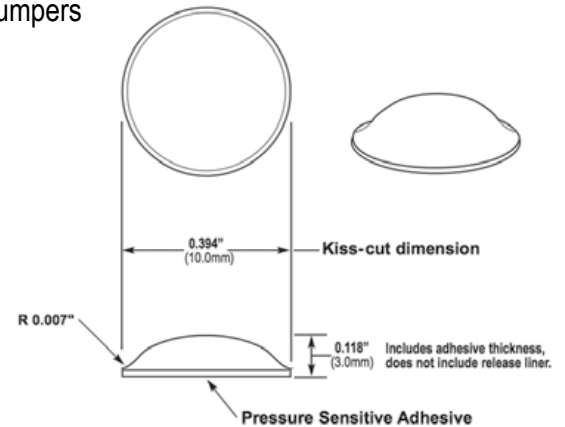

## QS-BS-12 Rounded Top Polyurethane Bumpers

These parts are rounded on top and have a dome shape that absorbs impact and are ideal to prevent skidding. This category includes our smallest profiles.

Diameter (inches) .375"  
Height (inches) .150"

Diameter (metric) 9.5mm  
Height (metric) 3.8mm

Bumpers per Sheet 288  
Sheets per Box 25  
Bumpers per Box 7,200

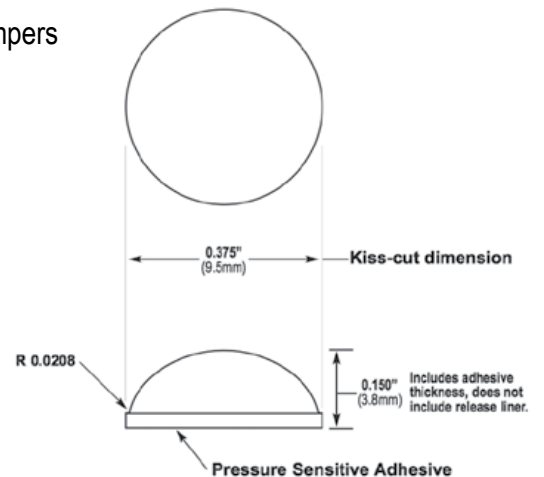

## QS-BS-15 Rounded Top Polyurethane Bumpers

These parts are rounded on top and have a dome shape that absorbs impact and are ideal to prevent skidding. This category includes our smallest profiles.

Diameter (inches) .620"  
Height (inches) .310"

Diameter (metric) 15.7mm  
Height (metric) 7.9mm

Bumpers per Sheet 128  
Sheets per Box 25  
Bumpers per Box 3,200

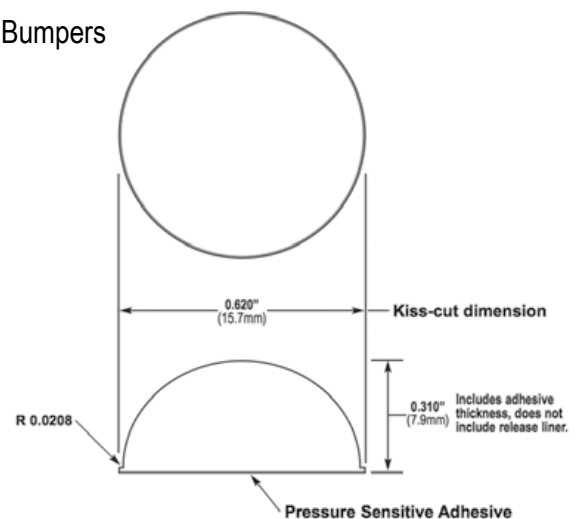

# HEMISPHERICAL

Product color options available in Clear, Black, White, Brown, and Grey



ISO 9001 Certified  
CERTIFICATE # 08-511



## QS-BS-22 Rounded Top Polyurethane Bumpers

These parts are rounded on top and have a dome shape that absorbs impact and are ideal to prevent skidding. This category includes our smallest profiles.

Diameter (inches) .375"  
Height (inches) .211"

Diameter (metric) 9.5mm  
Height (metric) 5.4mm

Bumpers per Sheet 300  
Sheets per Box 20  
Bumpers per Box 6,000

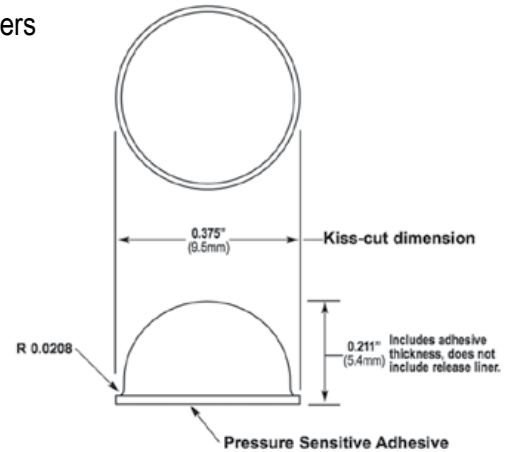

## QS-BS-25 Rounded Top Polyurethane Bumpers

These parts are rounded on top and have a dome shape that absorbs impact and are ideal to prevent skidding. This category includes our smallest profiles.

Diameter (inches) .250"  
Height (inches) .079"

Diameter (metric) 6.4mm  
Height (metric) 2.1mm

Bumpers per Sheet 450  
Sheets per Box 12  
Bumpers per Box 5,400

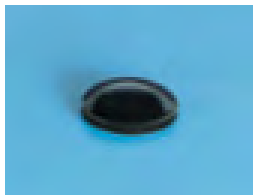
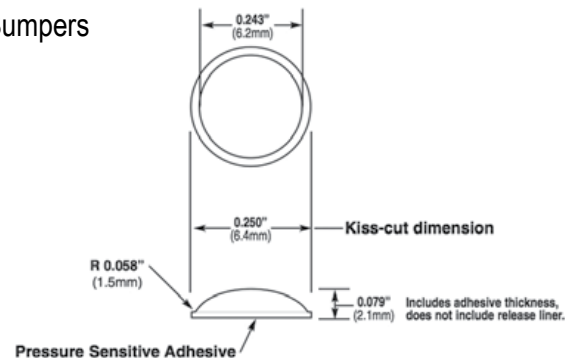

## QS-BS-27 Rounded Top Polyurethane Bumpers

These parts are rounded on top and have a dome shape that absorbs impact and are ideal to prevent skidding. This category includes our smallest profiles.

Diameter (inches) .312"  
Height (inches) .085"

Diameter (metric) 7.9mm  
Height (metric) 2.2mm

Bumpers per Sheet 450  
Sheets per Box 12  
Bumpers per Box 5,400

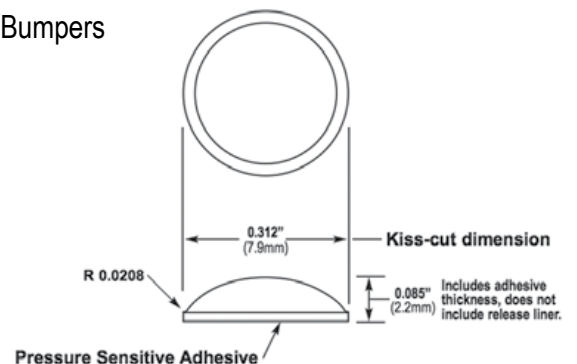

# HEMISPHERICAL

Product color options available in Clear, Black, White, Brown, and Grey



ISO 9001 Certified  
CERTIFICATE # 08-511

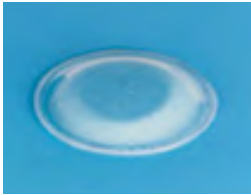

## QS-BS-39 Rounded Top Polyurethane Bumpers

These parts are rounded on top and have a dome shape that absorbs impact and are ideal to prevent skidding. This category includes our smallest profiles.

Diameter (inches) .750"  
Height (inches) .075"

Diameter (metric) 19.1mm  
Height (metric) 1.9mm

Bumpers per Sheet 84  
Sheets per Box 60  
Bumpers per Box 5,040

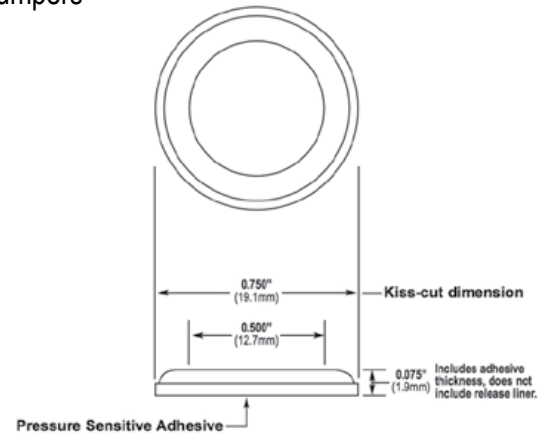

## QS-BS-40 Rounded Top Polyurethane Bumpers

These parts are rounded on top and have a dome shape that absorbs impact and are ideal to prevent skidding. This category includes our smallest profiles.

Diameter (inches) .250"  
Height (inches) .062"

Diameter (metric) 6.4mm  
Height (metric) 1.6mm

Bumpers per Sheet 578  
Sheets per Box 26  
Bumpers per Box 15,028

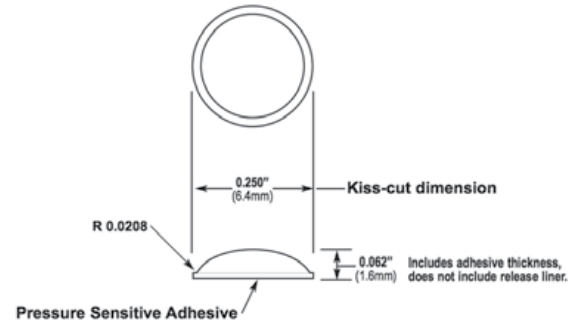

# RECESSED

Product color options available in Clear, Black, White, Brown, and Grey



ISO 9001 Certified  
CERTIFICATE # 08-511



Diameter (inches) .880"  
Height (inches) .400"

Diameter (metric) 22.3mm  
Height (metric) 10.2mm

Bumpers per Sheet 72  
Sheets per Box 20  
Bumpers per Box 1,440

## QS-BS-17 Recessed Polyurethane Bumpers

Recessed Bumpers have a hole half way through the center. The profile is adhesive backed; the use of a screw, nail, or staple may be used to fasten the Bumper for a more permanent attachment. They are also used for high impact applications such as large door enclosures.

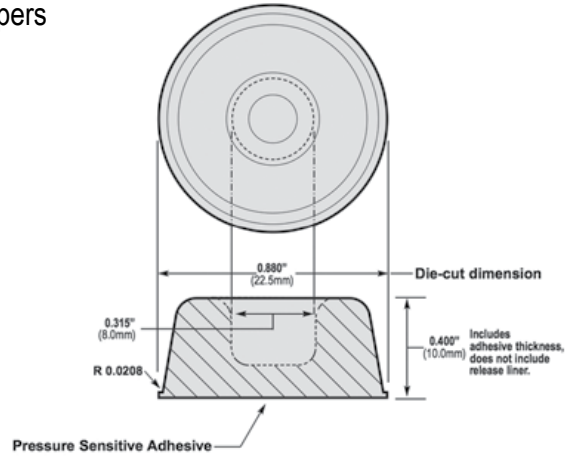

Diameter (inches) .500"  
Height (inches) .140"

Diameter (metric) 12.7mm  
Height (metric) 3.5mm

Bumpers per Sheet 200  
Sheets per Box 25  
Bumpers per Box 5,000

## QS-BS-18 Recessed Polyurethane Bumpers

Recessed Bumpers have a hole half way through the center. The profile is adhesive backed; the use of a screw, nail, or staple may be used to fasten the Bumper for a more permanent attachment. They are also used for high impact applications such as large door enclosures.

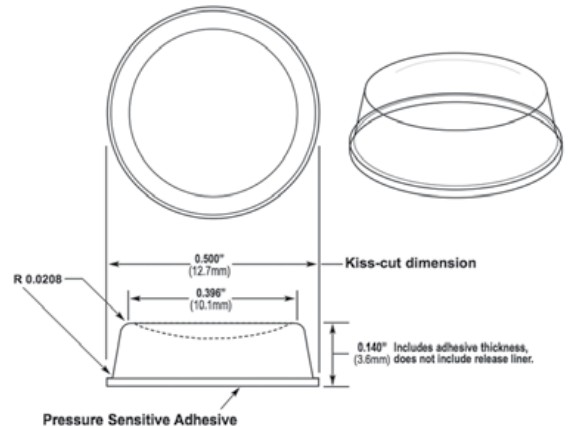

Diameter (inches) 1.810"  
Height (inches) .600"

Diameter (metric) 46.0mm  
Height (metric) 15.2mm

Bumpers per Sheet 1  
Bumpers per Box 500

## QS-BS-30 Recessed Polyurethane Bumpers

Recessed Bumpers have a hole half way through the center. The profile is adhesive backed; the use of a screw, nail, or staple may be used to fasten the Bumper for a more permanent attachment. They are also used for high impact applications such as large door enclosures.

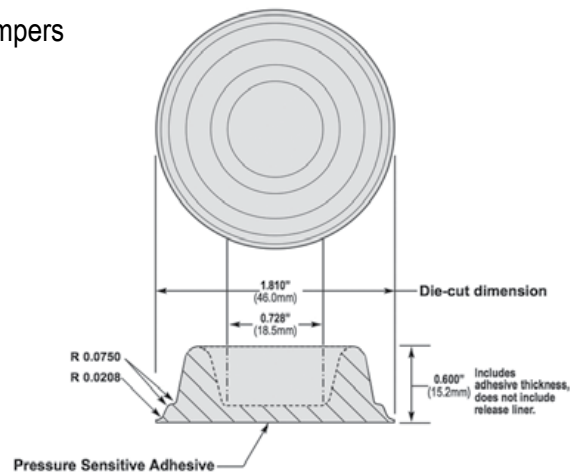

# SPECIAL SOFT

Product color options available in Clear, Black, White, Brown, and Grey



ISO 9001 Certified  
CERTIFICATE # 08-511

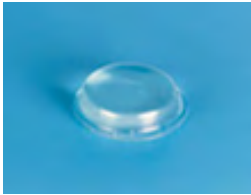

Diameter (inches) .500"  
Height (inches) .140"

Diameter (metric) 12.7mm  
Height (metric) 3.5mm

Bumpers per Sheet 200  
Sheets per Box 25  
Bumpers per Box 5,000

## QS-BS-01SD Soft Durometer Bumpers

Our Soft Durometer (SD) Bumpers have been specifically engineered to provide the quietest closure available for any cabinet door, drawer, or enclosure. The Soft Durometer Bumpers use a device called "Flexible Softness" which absorbs the physical force of any impact by more than half. A very soft polyurethane material and varying unique designs are employed to achieve this impressive result. The Soft Durometer Bumpers were not designed for load bearing applications.

The Soft Durometer line is made exclusively out of Clear material. Colors are available upon special request.

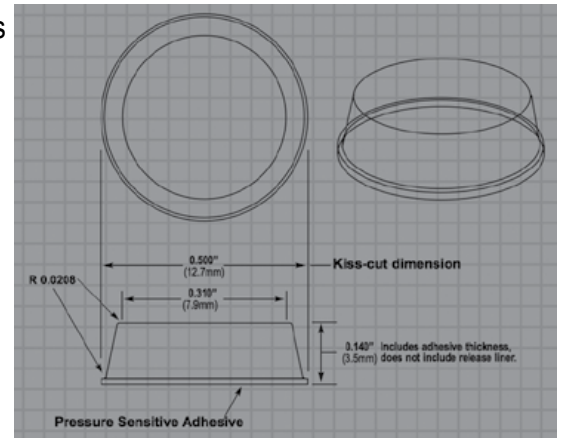

Diameter (inches) .440"  
Height (inches) .200"

Diameter (metric) 11.1mm  
Height (metric) 5.1mm

Bumpers per Sheet 55  
Sheets per Box 92  
Bumpers per Box 5,060

## QS-BS-02SD Soft Durometer Bumpers

Our Soft Durometer (SD) Bumpers have been specifically engineered to provide the quietest closure available for any cabinet door, drawer, or enclosure. The Soft Durometer Bumpers use a device called "Flexible Softness" which absorbs the physical force of any impact by more than half. A very soft polyurethane material and varying unique designs are employed to achieve this impressive result. The Soft Durometer Bumpers were not designed for load bearing applications.

The Soft Durometer line is made exclusively out of Clear material. Colors are available upon special request.

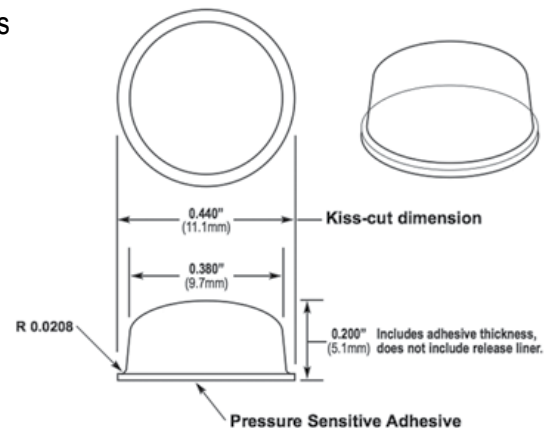

Diameter (inches) .335"  
Height (inches) .085"

Diameter (metric) 8.5mm  
Height (metric) 2.2mm

Bumpers per Sheet 450  
Sheets per Box 12  
Bumpers per Box 5,400

## QS-BS-07SD Soft Durometer Bumpers

Our Soft Durometer (SD) Bumpers have been specifically engineered to provide the quietest closure available for any cabinet door, drawer, or enclosure. The Soft Durometer Bumpers use a device called "Flexible Softness" which absorbs the physical force of any impact by more than half. A very soft polyurethane material and varying unique designs are employed to achieve this impressive result. The Soft Durometer Bumpers were not designed for load bearing applications.

The Soft Durometer line is made exclusively out of Clear material. Colors are available upon special request.

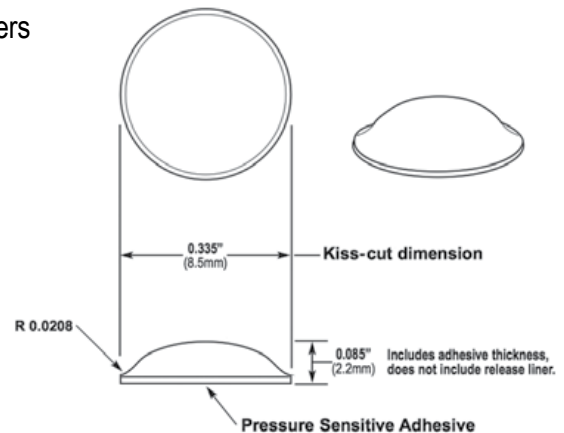

# SPECIAL SOFT

Product color options available in Clear, Black, White, Brown, and Grey



ISO 9001 Certified  
CERTIFICATE # 08-511



Diameter (inches) .375"  
Height (inches) .150"

Diameter (metric) 9.5mm  
Height (metric) 3.8mm

Bumpers per Sheet 288  
Sheets per Box 25  
Bumpers per Box 7,200

## QS-BS-12SD Soft Durometer Bumpers

Our Soft Durometer (SD) Bumpers have been specifically engineered to provide the quietest closure available for any cabinet door, drawer, or enclosure. The Soft Durometer Bumpers use a device called "Flexible Softness" which absorbs the physical force of any impact by more than half. A very soft polyurethane material and varying unique designs are employed to achieve this impressive result. The Soft Durometer Bumpers were not designed for load bearing applications.

The Soft Durometer line is made exclusively out of Clear material. Colors are available upon special request.

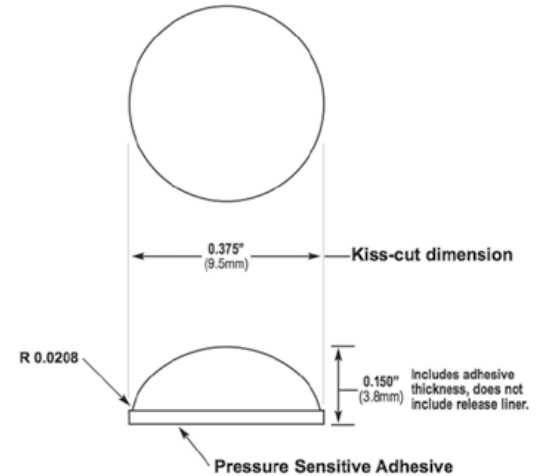

Diameter (inches) .500"  
Height (inches) .140"

Diameter (metric) 12.7mm  
Height (metric) 3.5mm

Bumpers per Sheet 200  
Sheets per Box 25  
Bumpers per Box 5,000

## QS-BS-18SD Soft Durometer Bumpers

Our Soft Durometer (SD) Bumpers have been specifically engineered to provide the quietest closure available for any cabinet door, drawer, or enclosure. The Soft Durometer Bumpers use a device called "Flexible Softness" which absorbs the physical force of any impact by more than half. A very soft polyurethane material and varying unique designs are employed to achieve this impressive result. The Soft Durometer Bumpers were not designed for load bearing applications.

The Soft Durometer line is made exclusively out of Clear material. Colors are available upon special request.

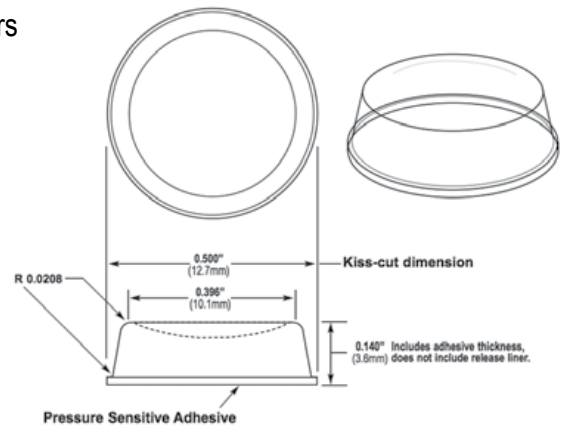

Diameter (inches) .375"  
Height (inches) .211"

Diameter (metric) 9.5mm  
Height (metric) 5.4mm

Bumpers per Sheet 300  
Sheets per Box 20  
Bumpers per Box 6,000

## QS-BS-22SD Soft Durometer Bumpers

Our Soft Durometer (SD) Bumpers have been specifically engineered to provide the quietest closure available for any cabinet door, drawer, or enclosure. The Soft Durometer Bumpers use a device called "Flexible Softness" which absorbs the physical force of any impact by more than half. A very soft polyurethane material and varying unique designs are employed to achieve this impressive result. The Soft Durometer Bumpers were not designed for load bearing applications.

The Soft Durometer line is made exclusively out of Clear material. Colors are available upon special request.

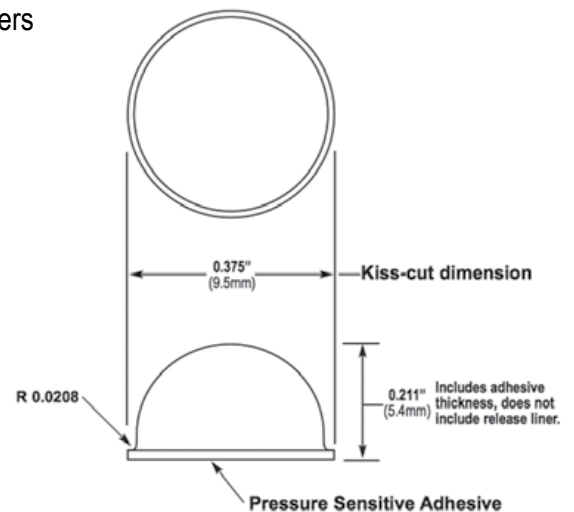

# SPECIAL SOFT

Product color options available in Clear, Black, White, Brown, and Grey



ISO 9001 Certified  
CERTIFICATE # 08-511

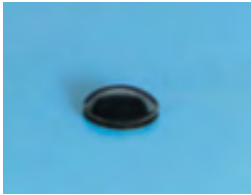

Diameter (inches) .312"  
Height (inches) .085"

Diameter (metric) 7.9mm  
Height (metric) 2.2mm

Bumpers per Sheet 450  
Sheets per Box 12  
Bumpers per Box 5,400

## QS-BS-27SD Soft Durometer Bumpers

Our Soft Durometer (SD) Bumpers have been specifically engineered to provide the quietest closure available for any cabinet door, drawer, or enclosure. The Soft Durometer Bumpers use a device called "Flexible Softness" which absorbs the physical force of any impact by more than half. A very soft polyurethane material and varying unique designs are employed to achieve this impressive result. The Soft Durometer Bumpers were not designed for load bearing applications.

The Soft Durometer line is made exclusively out of Clear material. Colors are available upon special request.

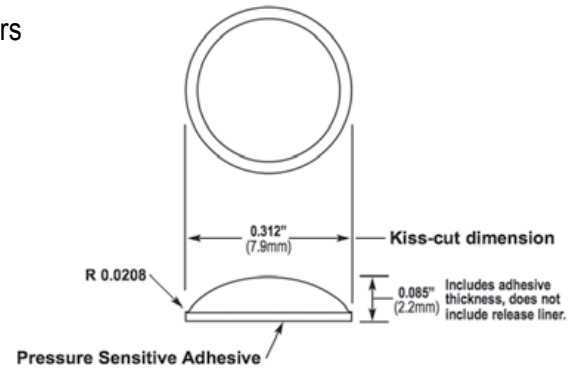

Diameter (inches) .500"  
Height (inches) .150"

Diameter (metric) 12.7mm  
Height (metric) 3.8mm

Bumpers per Sheet 200  
Sheets per Box 25  
Bumpers per Box 5,000

## QS-BS-33SD Soft Durometer Bumpers

Our Soft Durometer (SD) Bumpers have been specifically engineered to provide the quietest closure available for any cabinet door, drawer, or enclosure. The Soft Durometer Bumpers use a device called "Flexible Softness" which absorbs the physical force of any impact by more than half. A very soft polyurethane material and varying unique designs are employed to achieve this impressive result. The Soft Durometer Bumpers were not designed for load bearing applications.

The Soft Durometer line is made exclusively out of Clear material. Colors are available upon special request.

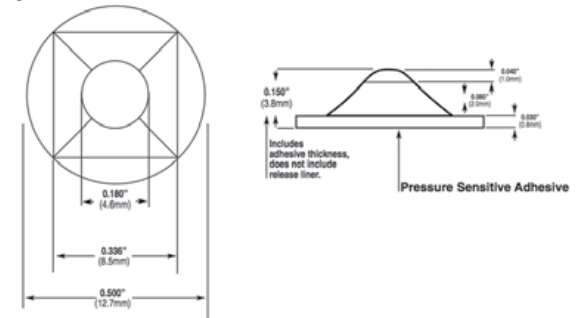

Diameter (inches) .375"  
Height (inches) .125"

Diameter (metric) 9.5mm  
Height (metric) 3.2mm

Bumpers per Sheet 300  
Sheets per Box 20  
Bumpers per Box 6,000

## QS-BS-34SD Soft Durometer Bumpers

Our Soft Durometer (SD) Bumpers have been specifically engineered to provide the quietest closure available for any cabinet door, drawer, or enclosure. The Soft Durometer Bumpers use a device called "Flexible Softness" which absorbs the physical force of any impact by more than half. A very soft polyurethane material and varying unique designs are employed to achieve this impressive result. The Soft Durometer Bumpers were not designed for load bearing applications.

The Soft Durometer line is made exclusively out of Clear material. Colors are available upon special request.

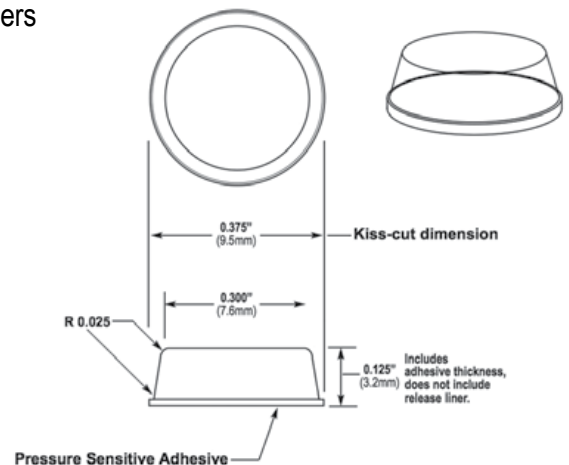



# SPECIAL SOFT

Product color options available in Clear, Black, White, Brown, and Grey



ISO 9001 Certified  
CERTIFICATE # 08-511



Diameter (inches) .500"  
Height (inches) .200"

Diameter (metric) 12.7mm  
Height (metric) 5.1mm

Bumpers per Sheet 200  
Sheets per Box 25  
Bumpers per Box 5,000

## QS-BS-58SD Soft Durometer Bumpers

Our Soft Durometer (SD) Bumpers have been specifically engineered to provide the quietest closure available for any cabinet door, drawer, or enclosure. The Soft Durometer Bumpers use a device called "Flexible Softness" which absorbs the physical force of any impact by more than half. A very soft polyurethane material and varying unique designs are employed to achieve this impressive result. The Soft Durometer Bumpers were not designed for load bearing applications.

The Soft Durometer line is made exclusively out of Clear material. Colors are available upon special request.

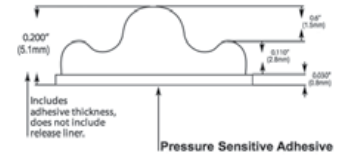
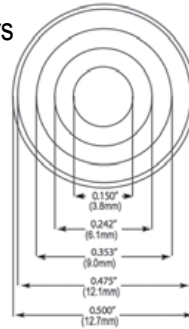

Diameter (inches) .375"  
Height (inches) .180"

Diameter (metric) 9.5mm  
Height (metric) 4.6mm

Bumpers per Sheet 288  
Sheets per Box 25  
Bumpers per Box 7,200

## QS-BS-67SD Soft Durometer Bumpers

Our Soft Durometer (SD) Bumpers have been specifically engineered to provide the quietest closure available for any cabinet door, drawer, or enclosure. The Soft Durometer Bumpers use a device called "Flexible Softness" which absorbs the physical force of any impact by more than half. A very soft polyurethane material and varying unique designs are employed to achieve this impressive result. The Soft Durometer Bumpers were not designed for load bearing applications.

The Soft Durometer line is made exclusively out of Clear material. Colors are available upon special request.

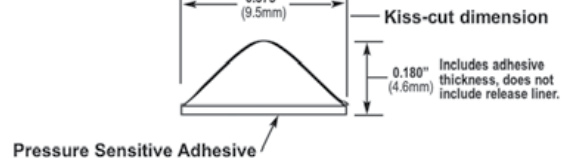
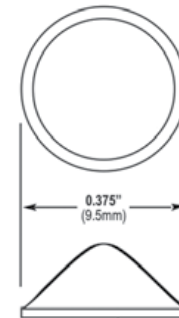

**SQUARE**

Product color options available in Clear, Black, White, Brown, and Grey



ISO 9001 Certified  
CERTIFICATE # 08-511

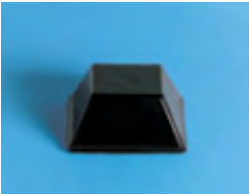

**QS-BS-03** Tapered Square Bumpers

The tapered square Bumpers consist of the largest surface contact area of any of our products.

Width (inches) .500"  
Height (inches) .230"

Width (metric) 12.7mm  
Height (metric) 5.8mm

Bumpers per Sheet 200  
Sheets per Box 25  
Bumpers per Box 5,000

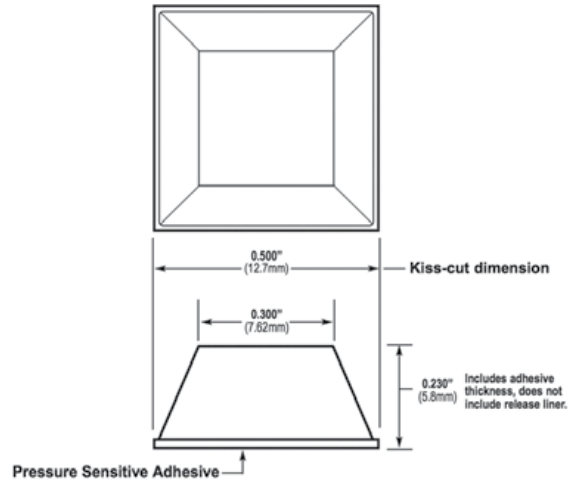

**QS-BS-04** Tapered Square Bumpers

The tapered square Bumpers consist of the largest surface contact area of any of our products.

Width (inches) .780"  
Height (inches) .380"

Width (metric) 19.8mm  
Height (metric) 9.7mm

Bumpers per Sheet 1  
Bumpers per Box 2,000

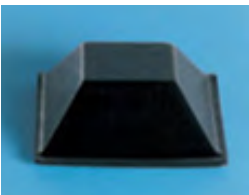
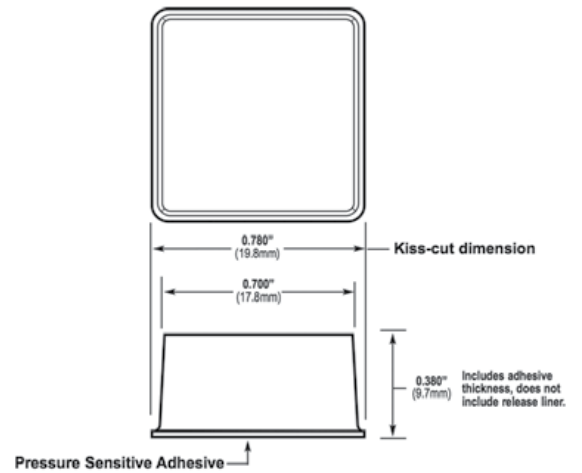

**QS-BS-19** Tapered Square Bumpers

The tapered square Bumpers consist of the largest surface contact area of any of our products.

Width (inches) .810"  
Height (inches) .300"

Width (metric) 20.6mm  
Height (metric) 7.6mm

Bumpers per Sheet 98  
Sheets per Box 27  
Bumpers per Box 2,646

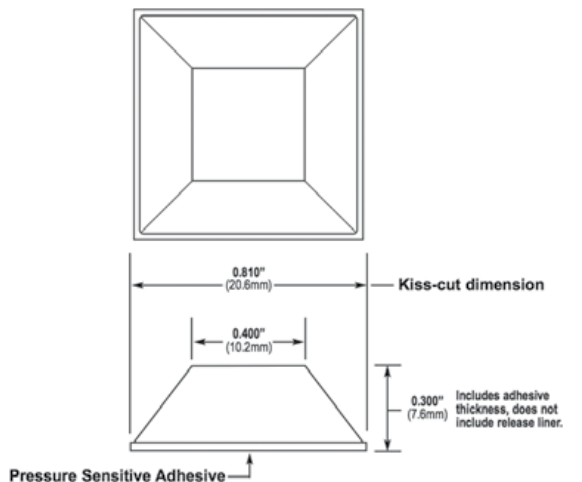

# SQUARE

Product color options available in Clear, Black, White, Brown, and Grey



ISO 9001 Certified  
CERTIFICATE # 08-511



## QS-BS-20 Tapered Square Bumpers

The tapered square Bumpers consist of the largest surface contact area of any of our products.

Width (inches) .400"  
Height (inches) .100"

Width (metric) 10.2mm  
Height (metric) 2.5mm

Bumpers per Sheet 242  
Sheets per Box 21  
Bumpers per Box 5,082

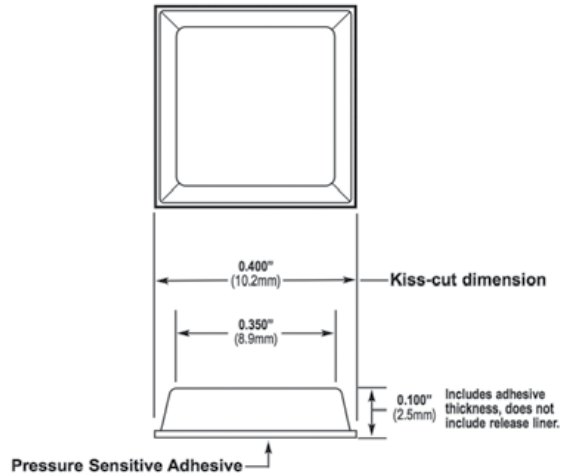

## QS-BS-29 Tapered Square Bumpers

The tapered square Bumpers consist of the largest surface contact area of any of our products.

Width (inches) .780"  
Height (inches) .250"

Width (metric) 19.8mm  
Height (metric) 6.4mm

Bumpers per Sheet 98  
Sheets per Box 30  
Bumpers per Box 2,940

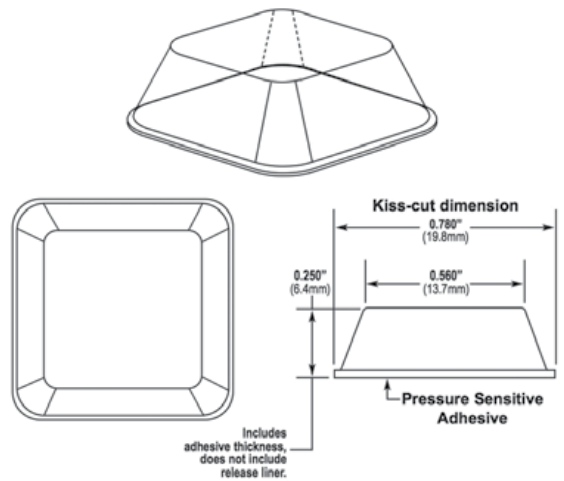

## QS-BS-32 Tapered Square Bumpers

The tapered square Bumpers consist of the largest surface contact area of any of our products.

Width (inches) .500"  
Height (inches) .120"

Width (metric) 12.7mm  
Height (metric) 3.0mm

Bumpers per Sheet 200  
Sheets per Box 25  
Bumpers per Box 5,000

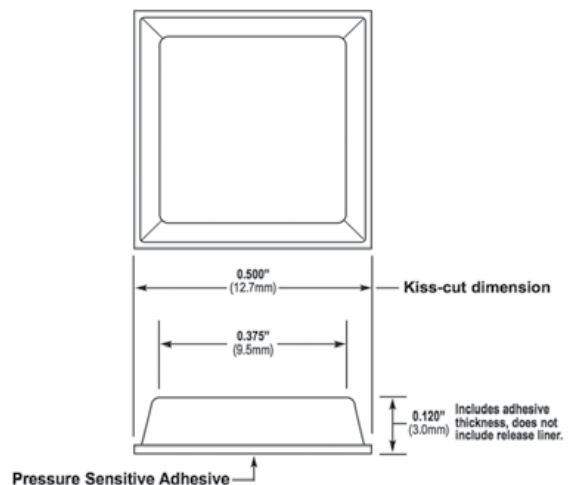

# SQUARE

Product color options available in Clear, Black, White, Brown, and Grey



ISO 9001 Certified  
CERTIFICATE # 08-511

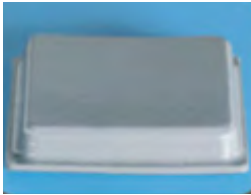

## QS-BS-36 Tapered Square Bumpers

The tapered square Bumpers consist of the largest surface contact area of any of our products.

Width (inches) 1.000"  
Height (inches) .180"

Width (metric) 25.4mm  
Height (metric) 4.6mm

Bumpers per Sheet 55  
Sheets per Box 42  
Bumpers per Box 2,310

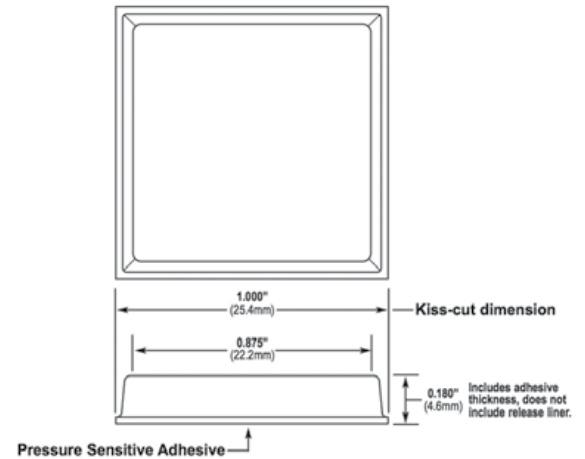

# BUTTON BUMPERS

By "E" Dimension



PART NO.	Fig No.	A			B			C			D			E			F		
		Inch	Dec	MM	Inch	Dec	MM	Inch	Dec	MM	Inch	Dec	MM	Inch	Dec	MM	Inch	Dec	MM
E-4273	5	15/64	0.234	6.0	11/64	0.165	4.2	1/8	0.125	3.2	7/32	0.218	5.6	1/32	0.031	0.8	3/32	0.094	2.4
E-3161	5	5/16	0.313	7.9	3/16	0.188	4.8	1/8	0.125	3.2	3/16	0.188	4.8	3/64	0.047	1.2	1/32	0.031	0.8
E-2433	7	1/2	0.500	12.7	9/64	0.141	3.6	13/64	0.203	5.2	19/64	0.297	7.5	3/64	0.047	1.2	3/64	0.047	1.2
E-2618	2	13/64	0.200	5.1	11/64	0.165	4.2	1/16	0.062	0.7	1/64	0.100	2.6	3/64	0.048	1.2	5/64	0.070	1.8
E-2963	6	3/8	0.378	9.6	1/2	0.500	12.7	11/64	0.169	4.3	15/64	0.228	5.9	1/16	0.059	1.5	3/64	0.040	1.0
E-2906	1	15/32	0.475	12.2	11/32	0.342	8.7	1/8	0.125	3.2	9/64	0.145	3.7	1/16	0.062	1.6	15/64	0.235	6.0
E-3058	1	17/32	0.531	13.5	17/64	0.266	6.8	15/64	0.234	6.0	19/64	0.297	7.5	1/16	0.063	1.6	3/64	0.047	1.2
E-3066	7	3/8	0.375	9.5	3/16	0.188	4.8	1/4	0.250	6.4	5/16	0.313	7.9	1/16	0.063	1.6	1/16	0.063	1.6
E-3169	1	3/8	0.375	9.5	1/4	0.250	6.4	1/4	0.250	6.4	5/16	0.313	7.9	1/16	0.063	1.6	5/64	0.070	1.8
E-3171	1	1/2	0.500	12.7	17/64	0.266	6.7	9/32	0.281	7.1	3/8	0.375	9.5	1/16	0.063	1.6	3/64	0.047	1.1
E-2682	1	1/2	0.500	12.7	19/64	0.297	7.5	1/4	0.250	6.4	1/2	0.500	12.7	1/16	0.063	1.6	1/16	0.063	1.6
E-3188	5	5/16	0.313	7.9	7/32	0.219	5.6	1/8	0.125	3.2	3/16	0.188	4.8	1/16	0.063	1.6	1/16	0.063	1.6
E-3266	7	3/8	0.375	9.5	3/16	0.188	4.8	1/4	0.250	6.4	5/16	0.313	7.9	1/16	0.063	1.6	1/32	0.031	0.8
E-2935	7	3/8	0.375	9.5	7/32	0.219	5.6	1/4	0.250	6.3	5/16	0.313	7.9	1/16	0.063	1.5	1/16	0.063	1.5
E-3269	1	3/8	0.375	9.5	17/64	0.266	6.7	1/4	0.250	6.4	5/16	0.313	7.9	1/16	0.063	1.6	3/32	0.090	2.3
E-4081	1	9/16	0.563	14.3	1/4	0.250	6.4	9/32	0.281	7.1	3/8	0.375	9.5	1/16	0.063	1.6	1/16	0.063	1.6
E-4182	1	5/8	0.625	15.9	9/32	0.281	7.1	3/16	0.188	4.8	7/32	0.219	5.6	1/16	0.063	1.6	1/32	0.031	0.8
E-2427	1	7/16	0.438	11.1	5/16	0.313	7.9	1/4	0.250	6.4	11/32	0.344	8.7	1/16	0.063	1.6	1/32	0.031	0.8
E-289	7	3/8	0.375	9.5	7/32	0.219	5.6	1/4	0.250	6.4	5/16	0.313	7.9	1/16	0.063	1.6	1/16	0.063	1.6
E-3307	6	31/82	0.378	9.6	39/74	0.527	13.4	8/47	0.170	4.3	3/13	0.230	5.8	1/14	0.072	1.8	3/79	0.038	1.0
E-2668	2	1/4	0.250	6.4	9/64	0.141	3.6	1/8	0.125	3.2	3/16	0.188	4.8	5/64	0.077	2.0	1/32	0.031	0.8
E-4267	6	1/4	0.250	6.4	9/32	0.277	7.0	1/8	0.125	3.2	3/16	0.188	4.8	5/64	0.077	2.0	1/32	0.032	0.8
E-3070	7	3/8	0.375	9.5	7/32	0.219	5.6	1/4	0.250	6.4	5/16	0.313	7.9	5/64	0.078	2.0	1/16	0.063	1.6
E-3174*	1	5/16	0.313	7.9	1/4	0.250	6.4	3/16	0.188	4.8	1/4	0.250	6.4	5/64	0.078	2.0	1/16	0.063	1.6
E-2621	2	1/4	0.250	6.4	3/8	0.375	9.5	1/8	0.125	3.2	3/16	0.187	4.8	3/32	0.093	2.4	3/32	0.094	2.4
E-3301	1	1/2	0.500	12.7	12/35	0.343	8.7	3/16	0.187	4.7	1/4	0.250	6.4	3/32	0.093	2.4	1/16	0.062	1.6
E-3062	1	3/8	0.375	9.5	1/4	0.250	6.4	1/4	0.250	6.4	5/16	0.313	7.9	3/32	0.094	2.4	3/64	0.047	1.2
E-3064	2	7/16	0.438	11.1	19/64	0.297	7.5	15/64	0.234	6.0	19/64	0.297	7.5	3/32	0.094	2.4	3/64	0.047	1.2
E-3069	S	5/16	0.313	7.9	5/16	0.313	7.9	1/8	0.125	3.2	3/16	0.188	4.8	3/32	0.094	2.4	1/32	0.031	0.8

\* Indicates inserting hole in base and stem. \*\* Special Design-Inverted "A" dimension, stepped "E" dimension.

Button Bumpers (catch bumpers) are an easy way to affix cushioning to products and equipment. These bumpers are attached without need for screws or other fasteners - the one-way "catch" end of the bumper is simply inserted into an appropriately-sized hole.

Flexible shutters adjust to accommodate and support any shape from .125" (3,2 mm) to a maximum diameter of 2.470" (62,7 mm).

Absorbs vibration and cushions and insulates cables, tubing, hoses or shafts with limited internal clearance.

Fingertip pressure snap-locks the bushing into its mounting hole.

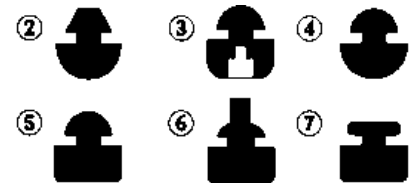
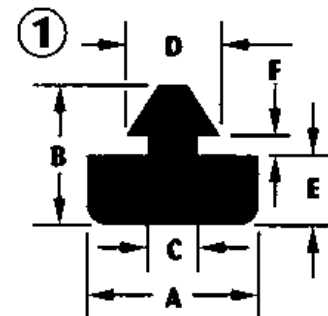

ISO 9001 Certified  
CERTIFICATE # 08-511



# BUTTON BUMPERS

By "E" Dimension



PART NO.	Fig No.	A			B			C			D			E			F		
		Inch	Dec	MM	Inch	Dec	MM	Inch	Dec	MM	Inch	Dec	MM	Inch	Dec	MM	Inch	Dec	MM
E-4066†	5	7/16	0.438	11.1	1/2	0.500	12.7	1/4	0.250	6.4	3/8	0.375	9.5	1/8	0.125	3.2	1/16	0.063	1.6
E-4067	2	7/16	0.438	11.1	21/64	0.328	8.3	15/64	0.234	6.0	9/32	0.281	7.1	1/8	0.125	3.2	3/64	0.047	1.2
E-4071	1	1/2	0.500	12.7	3/8	0.375	9.5	3/16	0.188	4.8	1/4	0.250	6.4	1/8	0.125	3.2	1/16	0.063	1.6
E-4078	1	1/2	0.500	12.7	13/32	0.406	10.3	1/4	0.250	6.4	3/8	0.375	9.5	1/8	0.125	3.2	1/16	0.063	1.6
E-4083	7	5/8	0.625	15.9	9/32	0.281	7.1	13/32	0.406	10.3	17/32	0.531	13.5	1/8	0.125	3.2	3/32	0.094	2.4
E-4161	1	3/8	0.375	9.5	11/32	0.344	8.7	3/16	0.188	4.8	1/4	0.250	6.4	1/8	0.125	3.2	3/32	0.094	2.4
E-2938	5	9/16	0.563	14.2	23/64	0.359	9.2	9/32	0.281	7.2	3/8	0.375	9.5	1/8	0.125	3.1	5/64	0.078	2.0
E-4168	1	1/2	0.500	12.7	5/16	0.313	7.9	1/4	0.250	6.4	5/16	0.313	7.9	1/8	0.125	3.2	3/64	0.047	1.2
E-4184	1	5/8	0.625	15.9	11/32	0.344	8.7	15/64	0.234	6.0	5/16	0.313	7.9	1/8	0.125	3.2	3/64	0.040	1.0
E-4187	1	5/8	0.625	15.9	5/16	0.313	7.9	5/16	0.313	7.9	7/16	0.438	11.1	1/8	0.125	3.2	3/64	0.047	1.2
E-4193	1	1/2	0.500	12.7	5/16	0.313	7.9	3/8	0.375	9.5	33/64	0.516	13.1	1/8	0.125	3.2	1/16	0.063	1.6
E-4194*	1	1/2	0.500	12.7	1/2	0.500	12.7	1/4	0.250	6.4	25/64	0.391	9.9	1/8	0.125	3.2	1/4	0.250	6.4
E-4263	6	3/8	0.380	9.7	23/32	0.720	18.3	11/64	0.170	4.3	17/64	0.270	6.9	1/8	0.125	3.2	3/64	0.050	1.3
E-4268***	1	1/2	0.500	12.7	27/32	0.844	21.4	11/32	0.348	8.8	7/16	0.438	11.1	1/8	0.125	3.2	17/32	0.531	13.5
E-2949	5	1/2	0.500	12.7	11/32	0.344	8.8	1/4	0.250	6.3	5/16	0.313	7.9	1/8	0.125	3.1	1/8	0.125	3.1
E-4271	1	1/2	0.500	12.7	13/32	0.406	10.3	3/16	0.188	4.8	1/4	0.250	6.4	1/8	0.125	3.2	3/32	0.094	2.4
E-2959	5	17/32	0.531	13.6	13/32	0.406	10.4	1/4	0.250	6.3	11/32	0.344	8.8	1/8	0.125	3.1	1/8	0.125	3.1
E-4279*	2	1/2	0.500	12.7	1/2	0.500	12.7	3/32	0.090	2.3	11/32	0.344	8.7	1/8	0.125	3.2	1/16	0.063	1.6
E-2640*	1	7/8	0.875	22.2	1/2	0.500	12.7	17/32	0.531	13.6	11/16	0.688	17.5	1/8	0.125	3.2	3/64	0.047	1.2
E-2520	1	1/2	0.500	12.7	3/8	0.375	9.5	3/16	0.188	4.8	7/32	0.219	5.6	1/8	0.125	3.2	1/16	0.063	1.6
E-3347	1	3/4	0.750	19.1	9/16	0.563	14.3	1/3	0.330	8.4	7/16	0.438	11.1	1/8	0.125	3.2	3/16	0.188	4.8
E-284	5	5/16	0.313	7.9	9/32	0.281	7.1	1/8	0.125	3.2	3/16	0.188	4.8	1/8	0.125	3.2	1/32	0.031	0.8
E-711	5	9/16	0.563	14.3	3/8	0.375	9.5	1/4	0.250	6.4	11/32	0.344	8.7	1/8	0.125	3.2	1/8	0.125	3.2
E-785	1	5/16	0.313	7.9	17/64	0.266	6.7	3/16	0.188	4.8	1/4	0.250	6.4	1/8	0.125	3.2	3/64	0.047	1.2
E-862	1	5/16	0.313	7.9	1/4	0.250	6.4	3/16	0.188	4.8	1/4	0.250	6.4	1/8	0.125	3.2	1/16	0.063	1.6
E-1138	5	9/16	0.563	14.3	23/64	0.359	9.1	9/32	0.281	7.1	3/8	0.375	9.5	1/8	0.125	3.2	5/64	0.078	2.0
E-986	5	3/8	0.375	9.5	1/4	0.250	6.4	1/4	0.250	6.4	5/16	0.313	7.9	1/8	0.125	3.2	1/16	0.063	1.6
E-1439	2	3/8	0.375	9.5	3/8	0.375	9.5	3/16	0.188	4.8	1/4	0.250	6.4	1/8	0.125	3.2	1/32	0.031	0.8

Button Bumpers (catch bumpers) are an easy way to affix cushioning to products and equipment. These bumpers are attached without need for screws or other fasteners - the one-way "catch" end of the bumper is simply inserted into an appropriately-sized hole.

- Flexible shutters adjust to accommodate and support any shape from .125" (3,2 mm) to a maximum diameter of 2.470" (62,7 mm).
- Absorbs vibration and cushions and insulates cables, tubing, hoses or shafts with limited internal clearance.
- Fingertip pressure snap-locks the bushing into its mounting hole.

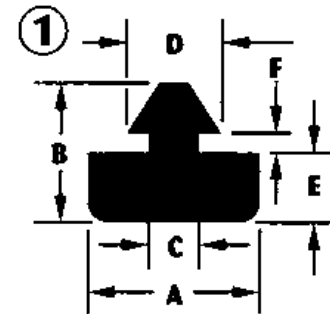

\* Indicates inserting hole in base and stem. \*\* Special Design-Inverted "A" dimension, stepped "E" dimension. \*\*\* Insert hole 3/16 Dia. X 11/16 deep. † See molded parts of irregular design.

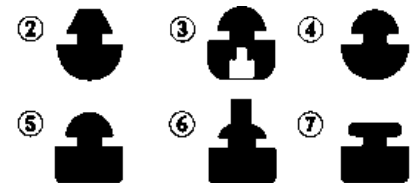





# BUTTON BUMPERS

By "E" Dimension



PART NO.	Fig No.	A			B			C			D			E			F		
		Inch	Dec	MM	Inch	Dec	MM	Inch	Dec	MM	Inch	Dec	MM	Inch	Dec	MM	Inch	Dec	MM
E-406	3	3/8	0.375	9.5	3/8	0.375	9.5	3/16	0.188	4.8	17/64	0.266	6.7	3/16	0.188	4.8	1/16	0.063	1.6
E-417	3	3/8	0.375	9.5	7/16	0.438	11.1	3/16	0.188	4.8	17/64	0.266	6.7	3/16	0.188	4.8	1/8	0.125	3.2
E-1161	1	3/4	0.750	19.1	9/16	0.563	14.3	31/64	0.480	1.2	37/64	0.578	14.7	3/16	0.188	4.8	3/64	0.050	1.3
E-1162	1	3/4	0.750	19.1	9/16	0.563	14.3	31/64	0.480	1.2	37/64	0.578	14.7	3/16	0.188	4.8	1/16	0.070	1.8
E-3063	1	7/16	0.438	11.1	23/64	0.359	9.1	1/4	0.250	6.4	5/16	0.313	7.9	3/16	0.188	4.8	3/64	0.047	1.2
E-3067*	2	5/16	0.313	7.9	19/32	0.594	15.1	3/16	0.188	4.7	1/4	0.250	6.4	3/16	0.188	4.8	1/32	0.031	0.8
E-3071	1	1/2	0.500	12.7	25/64	0.391	9.9	9/32	0.281	7.1	3/8	0.375	9.5	3/16	0.188	4.8	3/64	0.047	1.2
E-3165	6	1/4	0.250	6.4	9/16	0.563	14.3	1/8	0.125	3.2	7/32	0.219	5.6	3/16	0.188	4.8	3/64	0.047	1.2
E-3172	7	3/8	0.375	9.5	9/32	0.281	7.1	1/4	0.250	6.4	11/32	0.344	8.7	3/16	0.188	4.8	3/64	0.047	1.2
E-3181	1	1/2	0.500	12.7	27/64	0.422	10.7	9/32	0.281	7.1	3/8	0.375	9.5	3/16	0.188	4.8	5/64	0.078	2.0
E-3183*	2	3/8	0.375	9.5	1/2	0.500	12.7	3/16	0.188	4.8	1/4	0.250	6.4	3/16	0.188	4.8	1/16	0.063	1.6
E-3184*	2	3/8	0.375	9.5	15/32	0.469	11.9	3/16	0.188	4.8	1/4	0.250	6.4	3/16	0.188	4.8	1/32	0.031	0.8
E-3185	6	3/8	0.375	9.5	11/16	0.688	17.5	13/64	0.203	5.2	17/64	0.266	6.7	3/16	0.188	4.8	3/64	0.047	1.2
E-3263	5	7/16	0.438	11.1	7/16	0.438	11.1	1/4	0.250	6.4	5/16	0.313	7.9	3/16	0.188	4.8	1/8	0.125	3.2
E-4072	5	1/2	0.500	12.7	3/8	0.375	9.5	3/16	0.188	4.8	1/4	0.250	6.4	3/16	0.188	4.8	1/16	0.063	1.6
E-4076	2	1/2	0.500	12.7	7/16	0.438	11.1	1/4	0.250	6.4	5/16	0.313	7.9	3/16	0.188	4.8	1/16	0.063	1.6
E-4163	1	3/8	0.375	9.5	3/8	0.375	9.5	17/64	0.266	6.7	11/3	0.344	8.7	3/16	0.188	4.8	1/32	0.031	0.8
E-4171	1	1/2	0.500	12.7	7/16	0.438	11.1	3/16	0.188	4.8	1/4	0.250	6.4	3/16	0.188	4.8	1/16	0.063	1.6
E-4176	1	1/2	0.500	12.7	7/16	0.438	11.1	1/4	0.250	6.4	5/16	0.313	7.9	3/16	0.188	4.8	1/32	0.031	0.8
E-4178*	4	5/16	0.313	8.0	13/32	0.406	10.3	5/32	0.156	4.0	15/64	0.230	5.8	3/16	0.188	4.8	1/8	0.125	3.2
E-4270	1	3/4	0.750	19.1	7/16	0.438	11.1	11/32	0.344	8.7	15/32	0.469	11.9	3/16	0.188	4.8	1/8	0.125	3.2
E-4276	2	1/2	0.500	12.7	15/32	0.469	11.9	1/4	0.250	6.4	5/16	0.313	7.9	3/16	0.188	4.8	7/64	0.100	2.5
E-4280	6	15/32	0.469	12.0	25/32	0.780	20.0	1/4	0.250	6.4	5/16	0.313	7.9	3/16	0.188	4.8	1/16	0.063	1.6
E-4281	6	3/8	0.375	9.5	11/16	0.688	17.5	3/16	0.188	4.8	9/32	0.281	7.1	3/16	0.188	4.8	3/64	0.050	1.3
E-6113	1	3/4	0.750	19.1	3/4	0.750	19.1	1/4	0.250	6.4	3/8	0.375	9.5	3/16	0.188	4.8	1/16	0.063	1.6
E-2647	7	3/8	0.375	9.5	19/64	0.297	7.5	1/4	0.250	6.4	5/16	0.313	8.0	3/16	0.188	4.8	1/16	0.063	1.6
E-2969	4	1	1.000	25.4	7/16	0.438	11.1	1/2	0.500	12.7	5/8	0.625	15.9	3/16	0.188	4.8	1/8	0.125	3.2
E-759	1	7/16	0.438	11.1	23/64	0.359	9.1	1/4	0.250	6.4	5/16	0.313	7.9	3/16	0.188	4.8	3/64	0.047	1.2
E-693	4	1	1.000	25.4	7/16	0.438	11.1	1/2	0.500	12.7	5/8	0.625	15.9	3/16	0.188	4.8	1/8	0.125	3.2

\* Indicates inserting hole in base and stem. \*\* Special Design-Inverted "A" dimension, stepped "E" dimension. \*\*\* Insert hole 3/16 Dia. X 11/16 deep.

Button Bumpers (catch bumpers) are an easy way to affix cushioning to products and equipment. These bumpers are attached without need for screws or other fasteners - the one-way "catch" end of the bumper is simply inserted into an appropriately-sized hole.

- Flexible shutters adjust to accommodate and support any shape from .125" (3,2 mm) to a maximum diameter of 2.470" (62,7 mm).
- Absorbs vibration and cushions and insulates cables, tubing, hoses or shafts with limited internal clearance.
- Fingertip pressure snap-locks the bushing into its mounting hole.

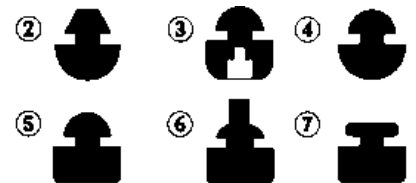
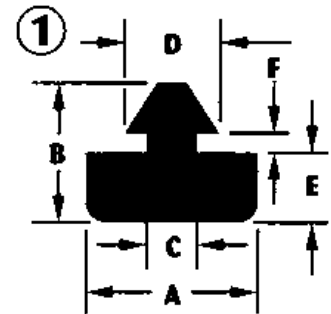



# BUTTON BUMPERS

By "E" Dimension



PART NO.	Fig No.	A			B			C			D			E			F		
		Inch	Dec	MM	Inch	Dec	MM	Inch	Dec	MM	Inch	Dec	MM	Inch	Dec	MM	Inch	Dec	MM
E-408	3	5/8	0.625	15.9	9/16	0.563	14.3	3/8	0.375	9.5	15/32	0.469	11.9	5/16	0.310	7.9	1/16	0.063	1.6
E-3075	1	7/16	0.438	11.1	5/8	0.625	15.9	5/16	0.313	7.9	13/32	0.406	10.3	5/16	0.310	7.9	1/32	0.031	0.8
E-4075	1	1/2	0.500	12.7	9/16	0.563	14.3	13/64	0.203	5.2	1/4	0.250	6.4	5/16	0.310	7.9	1/16	0.063	1.6
E-4181	6	1/2	0.500	12.7	61/64	0.953	24.2	1/4	0.250	6.4	3/8	0.375	9.5	5/16	0.310	7.9	1/8	0.125	3.2
E-4278	6	3/8	0.375	9.5	25/32	0.781	19.8	15/64	0.234	6.0	5/16	0.313	7.9	5/16	0.310	7.9	3/64	0.040	1.0
E-4287	1	1/2	0.500	12.7	9/16	0.563	14.3	1/4	0.250	6.4	5/16	0.313	7.9	5/16	0.310	7.9	9/64	0.141	3.6
E-2985	5	1	1.000	25.4	11/16	0.688	17.5	1/2	0.500	12.7	11/16	0.688	17.5	5/16	0.310	7.9	3/16	0.188	4.8
E-2605	6	22/71	0.310	7.9	31/50	0.620	15.7	3/25	0.120	3.0	15/79	0.190	4.8	22/71	0.310	7.9	3/50	0.060	1.5
E-740-B	5	9/16	0.563	14.3	15/32	0.469	11.9	11/32	0.344	8.7	13/32	0.406	10.3	5/16	0.313	7.9	1/16	0.063	1.6
E-2250	5	1	1.000	25.4	11/16	0.688	17.5	1/2	0.500	12.7	11/16	0.688	17.5	5/16	0.313	7.9	3/16	0.188	4.8
E-3351	5	1/2	0.500	12.7	37/64	0.581	14.8	1/4	0.250	6.4	3/8	0.375	9.5	5/16	0.313	8.0	3/32	0.093	2.4
E-3365	6	8/21	0.381	9.7	14/15	0.933	23.7	14/67	0.209	5.3	2/7	0.286	7.3	26/81	0.321	8.2	11/94	0.117	3.0
E-1422	5	5/8	0.625	15.9	41/64	0.641	16.3	9/32	0.281	7.1	7/16	0.438	11.1	11/32	0.344	8.7	1/8	0.125	3.2
E-2488	1	9/16	0.562	14.3	3/5	0.600	15.2	5/16	0.312	7.9	2/5	0.400	10.2	7/20	0.350	8.9	1/31	0.032	0.8
E-3349	6	8/29	0.276	7.0	86/91	0.945	24.0	8/51	0.157	4.0	21/89	0.236	6.0	17/48	0.354	9.0	3/38	0.079	2.0
E-4183*	1	9/16	0.563	14.3	21/32	0.656	16.7	1/4	0.250	6.4	19/64	0.297	7.5	23/64	0.359	9.1	1/32	0.031	0.8
E-4265	6	3/8	0.380	9.7	55/64	0.862	21.9	15/64	0.230	5.9	5/16	0.312	7.9	23/64	0.360	9.1	1/16	0.062	1.6
E-2542	6	8/25	0.320	8.1	23/25	0.920	23.4	4/25	0.160	4.1	7/25	0.280	7.1	9/25	0.360	9.1	1/16	0.063	1.6
E-3186	6	5/16	0.313	7.9	11/16	0.688	17.5	1/8	0.125	3.2	3/16	0.188	4.8	3/8	0.375	9.5	1/16	0.063	1.6
E-2663	1	1/2	0.500	12.7	39/64	0.600	15.4	13/64	0.203	5.2	1/4	0.250	6.4	3/8	0.375	9.5	1/16	0.063	1.6
E-2688**	2	1/2	0.500	12.7	15/16	0.938	23.8	1/4	0.250	6.4	3/8	0.375	9.5	3/8	0.375	9.5	1/8	0.125	3.2
E-4186*	1	9/16	0.563	14.3	11/16	0.688	17.5	1/4	0.250	6.4	11/32	0.344	8.7	3/8	0.375	9.5	1/32	0.031	0.8
E-4191	1	5/8	0.625	15.9	3/4	0.750	19.1	15/64	0.234	6.0	5/16	0.313	7.9	3/8	0.375	9.5	1/8	0.125	3.2
E-2601	1	9/16	0.563	14.3	11/16	0.688	17.5	1/4	0.250	6.4	11/32	0.344	8.7	3/8	0.375	9.5	3/64	0.047	1.2
E-2671	2	3/4	0.750	19.1	21/32	0.656	16.7	5/16	0.320	8.1	1/2	0.500	12.7	3/8	0.375	9.5	3/64	0.045	1.1
E-4087	1	5/8	0.625	15.9	23/32	0.710	18.0	15/64	0.230	6.0	19/64	0.300	7.6	3/8	0.380	9.6	5/64	0.080	2.0
E-1165	6	7/8	0.875	22.2	1 1/32	1.031	26.2	1/4	0.250	6.4	13/32	0.406	10.3	13/32	0.406	10.3	5/64	0.078	2.0
E-1178-3	1	1/2	0.500	12.7	21/32	0.656	16.7	3/16	0.188	4.8	1/4	0.250	6.4	13/32	0.406	10.3	1/16	0.063	1.6
E-4264	1	3/8	0.375	9.5	23/32	0.719	18.4	1/4	0.250	6.4	11/32	0.344	8.7	1/2	0.500	12.7	1/16	0.063	1.6

\* Indicates inserting hole in base and stem. \*\* Special Design-Inverted "A" dimension, stepped "E" dimension. \*\*\* Insert hole 3/16 Dia. X 11/16 deep.

Button Bumpers (catch bumpers) are an easy way to affix cushioning to products and equipment. These bumpers are attached without need for screws or other fasteners - the one-way "catch" end of the bumper is simply inserted into an appropriately-sized hole.

Flexible shutters adjust to accommodate and support any shape from .125" (3,2 mm) to a maximum diameter of 2.470" (62,7 mm).

Absorbs vibration and cushions and insulates cables, tubing, hoses or shafts with limited internal clearance.

Fingertip pressure snap-locks the bushing into its mounting hole.

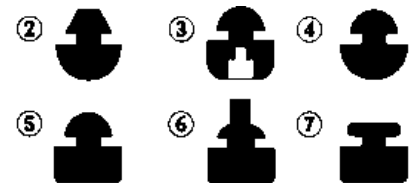
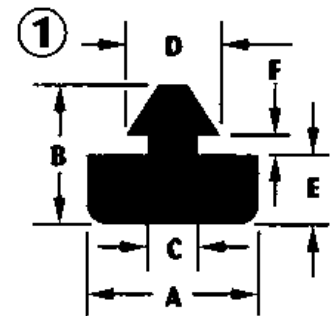



# BUTTON BUMPERS

By "E" Dimension

Button Bumpers (catch bumpers) are an easy way to affix cushioning to products and equipment. These bumpers are attached without need for screws or other fasteners - the one-way "catch" end of the bumper is simply inserted into an appropriately-sized hole.

Flexible shutters adjust to accommodate and support any shape from .125" (3,2 mm) to a maximum diameter of 2.470" (62,7 mm).

- Absorbs vibration and cushions and insulates cables, tubing, hoses or shafts with limited internal clearance. Fingertip pressure snap-locks the bushing into its mounting hole.

PART NO.	Fig No.	A			B			C			D			E			F		
		Inch	Dec	MM	Inch	Dec	MM	Inch	Dec	MM	Inch	Dec	MM	Inch	Dec	MM	Inch	Dec	MM
E-4164	1	3/8	0.375	9.5	11/16	0.696	17.8	17/64	0.266	6.8	11/32	0.344	8.7	1/2	0.500	12.7	1/32	0.031	0.8
E-4166	5	7/16	0.438	11.1	21/32	0.656	16.7	1/4	0.250	6.4	11/32	0.344	8.7	1/2	0.500	12.7	1/32	0.031	0.8
E-4272*	1	1	1.000	25.4	1	1.000	25.4	3/8	0.375	9.5	1/2	0.500	12.7	1/2	0.500	12.7	1/8	0.125	3.2
E-4282	6	1	1.000	25.4	1 3/5	1.600	40.7	27/64	0.420	10.7	9/16	0.563	14.3	1/2	0.500	12.7	1/16	0.063	1.6
E-3344	6-1	66/67	0.985	25.0	1 7/24	1.292	32.8	10/41	0.244	6.2	10/27	0.370	9.4	21/41	0.512	13.0	1/8	0.126	3.2
E-4079	1	1/2	0.500	12.7	29/32	0.906	23.0	1/4	0.250	6.4	23/64	0.359	9.1	9/16	0.563	14.3	1/16	0.063	1.6
E-4190	6	1/2	0.500	12.7	110/73	1.137	29.2	15/64	0.240	6.2	3/8	0.380	9.7	9/16	0.563	14.3	7/64	0.109	2.8
E-4284	1	1/2	0.500	12.7	1 1/64	1.016	25.8	1/4	0.250	6.4	11/32	0.344	8.7	11/16	0.688	17.5	1/16	0.063	1.6
E-2689	2	1/2	0.500	12.7	1 1/4	1.250	31.7	1/4	0.250	6.4	3/8	0.375	9.5	11/16	0.688	17.5	1/8	0.125	3.2
E-2101	4	49/64	0.766	19.4	1	1.000	25.4	3/8	0.375	9.5	1/2	0.500	12.7	3/4	0.750	19.1	1/8	0.125	3.2

\* Indicates inserting hole in base and stem. \*\* Special Design-Inverted "A" dimension, stepped "E" dimension. \*\*\* Insert hole 3/16 Dia. X 11/16 deep.

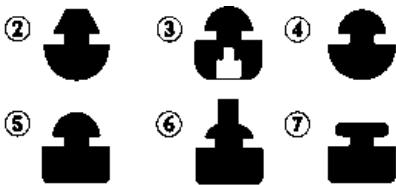
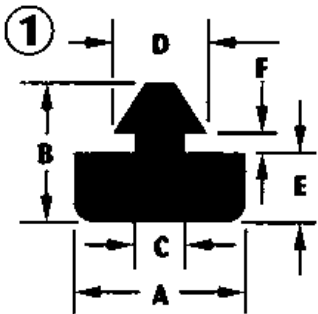

# END BUMPERS

By "D" Dimension



PART NO.	Fig No.	A			B			C			D			E						
		Inch	Dec	MM	Inch	Dec	MM	Inch	Dec	MM	Inch	Dec	MM	Inch	Dec	MM				
E-618	5	3/4	1/4	0.750	19.1	3/8	0.375	9.5	5/8	0.625	15.9	1/16	0.063	1.6	3/8	0.375	9.5			
E-627	4	3/8	7/8	0.250	6.4	1/4	0.250	6.4	3/16	0.188	4.8	3/32	0.094	2.4	1/4	0.250	6.4			
E-2657	4	5/16		0.375	9.5	1/4	0.240	6.1	9/32	0.281	7.1	3/32	0.094	2.4	1/4	0.240	6.1			
E-6182	5	9/32		0.875	22.2	1/2	0.500	12.7	1/2	0.500	12.7	3/32	0.094	2.4	1/2	0.500	12.7			
E-619	5	1/2		0.313	7.9	5/16	0.313	7.9	1/4	0.250	6.4	2/19	0.105	2.7	3/13	0.230	5.8	SPECIAL		
E-3364	5	7/16		0.282	7.2	7/32	0.225	5.7	7/32	0.221	5.6	7/64	0.104	2.6	7/32	0.225	5.7			
E-6203	3	3/8		0.500	12.7	3/8	0.375	9.5	3/8	0.375	9.5	7/64	0.105	2.7	1/4	0.250	6.4			
E-6206	3			0.438	11.1	11/32	0.344	8.7	21/64	0.328	8.3	7/64	0.105	2.7	13/64	0.203	5.2			
E-2997	5	7/16		0.375	9.5	1/4	0.250	6.4	9/32	0.281	7.1	7/64	0.115	2.9	1/4	0.250	6.4			
		7/8																		
E-125	5	19/64		0.438	11.1	1/4	0.250	6.4	5/16	0.313	7.9	1/8	0.125	3.2	7/32	0.219	5.6			
E-2051	1	1/2		0.875	22.2	7/16	0.438	11.1	3/4	0.750	19.1	1/8	0.125	3.2	3/8	0.375	9.5			
E-6183	5	3/8		0.297	7.5	1/4	0.250	6.4	7/32	0.219	5.6	1/8	0.125	3.2	1/4	0.250	6.4			
E-6201	3	5/8	1/2	0.500	12.7	3/8	0.375	9.5	3/8	0.375	9.5	1/8	0.125	3.2	1/4	0.250	6.4			
E-2960	4	39/64		0.375	9.5	1/4	0.250	6.4	9/32	0.281	7.1	1/8	0.125	3.2	1/4	0.250	6.4			
E-6181	S*	1/4		0.625	15.9	9/32	0.281	7.1	1/2	0.500	12.7	1/8*	0.125	3.2	3/8	0.375	9.5			
E-6205	3	1/4		0.500	12.7	3/8	0.375	9.5	3/8	0.375	9.5	9/64	0.140	3.6	1/4	0.250	6.4			
E-2455	5	11/16		0.609	15.5	39/64	0.609	15.5	15/32	0.469	11.9	9/64	0.141	3.6	1/4	0.250	6.4	SPECIAL		
E-632	4	9/25		0.250	6.4	11/32	0.344	8.7	5/32	0.156	4.0	9/64	0.141	3.6	11/32	0.344	8.7			
E-624	6	9/16		0.250	6.4	3/16	0.188	4.8	7/32	0.210	5.3	9/64	0.146	3.7	3/16	0.188	4.8			
E-2623	5	7/8		0.687	22.9	5/16	0.306	7.8	9/16	0.562	14.4	5/32	0.156	4.0	5/16	0.306	7.8			
E-2594	5	41/64		0.360	9.1	17/64	0.265	6.7	15/79	0.190	4.8	5/32	0.156	4.0	7/25	0.280	7.1	SPECIAL		
E-2943	5	1/2		0.563	14.2	23/64	0.359	9.2	7/16	0.438	11.1	5/32	0.156	4.0	23/64	0.359	9.2			
E-2053	1	1/2		0.875	22.2	7/16	0.438	11.1	3/4	0.750	19.1	5/32	0.161	4.0	3/8	0.375	9.5			
E-2602	5	1/2		0.635	16.1	5/16	0.306	7.8	9/16	0.563	14.3	5/32	0.161	4.0	5/16	0.306	7.8			
E-6208	6			0.500	12.7	7/32	0.219	5.6	3/8	0.375	9.5	5/32	0.161	4.0	7/32	0.219	5.6			
E-6204	3			0.500	12.7	3/8	0.375	9.5	3/8	0.375	9.5	5/32	0.161	4.1	1/4	0.250	6.4			
E-6202	3			0.500	12.7	3/8	0.375	9.5	3/8	0.375	9.5	11/64	0.175	4.4	1/4	0.250	6.4			

End Bumpers are used on the ends of tubes for shock and vibration reduction and the smoothing of edges.

- ABS, Buna-N, Butyl, EPDM, Neoprene, Nitrite, Natural Rubber, Santoprene, Silicone, Viton.
- Multiple sizes / applications
- Custom end bumpers available

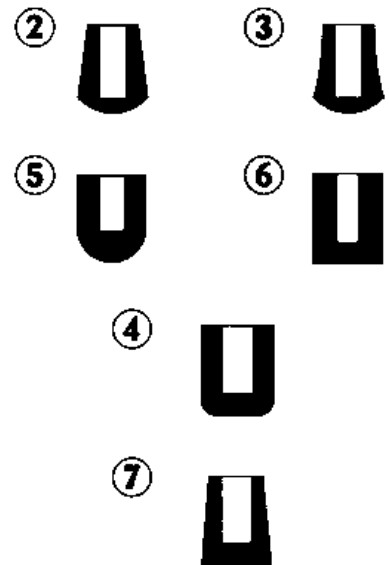
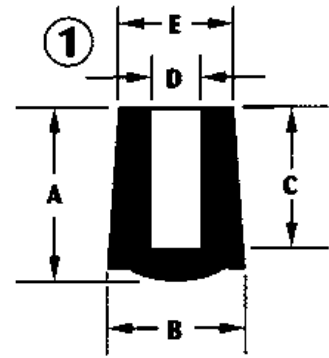

\* 5° taper on pin.





# END BUMPERS

By "D" Dimension

End Bumpers are used on the ends of tubes for shock and vibration reduction and the smoothing of edges.

- ABS, Buna-N, Butyl, EPDM, Neoprene, Nitrite, Natural Rubber, Santoprene, Silicone, Viton.
- Multiple sizes / applications
- Custom end bumpers available

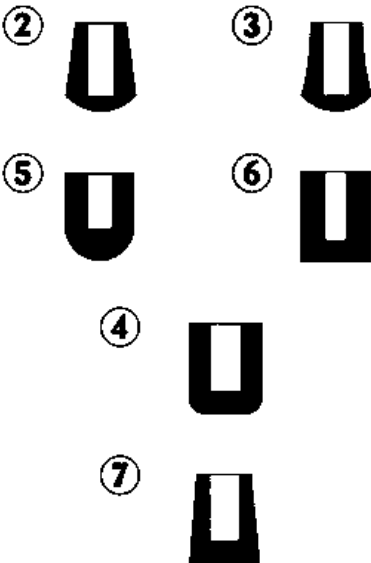
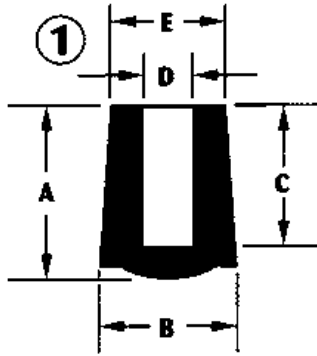

PART NO.	Fig No.	A			B			C			D			E					
		Inch	Dec	MM	Inch	Dec	MM	Inch	Dec	MM	Inch	Dec	MM	Inch	Dec	MM			
E-620	3	1/2	0.500	12.7	3/8	0.375	9.5	3/8	0.375	9.5	3/16	0.188	4.8	1/4	0.250	6.4			
E-621	6	3/8	0.375	9.5	1/2	0.500	12.7	1/4	0.250	6.4	3/16	0.188	4.8	1/2	0.500	12.7			
E-623	6	1 1/4	1.250	31.8	3/8	0.375	9.5	1	1.000	25.4	3/16	0.188	4.8	3/8	0.375	9.5			
E-631	4	11/16	0.688	17.5	3/8	0.375	9.5	5/8	0.625	15.9	3/16	0.188	4.8	3/8	0.375	9.5			
E-6822	5	39/64	0.600	15.2	1/4	0.250	6.4	7/16	0.438	11.1	3/16	0.188	4.8	1/4	0.250	6.4			
E-2566	6	21/32	0.656	16.7	1/2	0.500	12.7	17/32	0.531	13.5	14/69	0.203	5.2	1/2	0.500	12.7	SPECIAL		
E-2461	6	21/32	0.656	16.7	31/64	0.484	12.3	19/32	0.594	15.1	20/93	0.215	5.5	31/64	0.484	12.3	SPECIAL		
E-2508	6	21/32	0.656	16.7	31/64	0.484	12.3	33/64	0.516	13.1	20/93	0.215	5.5	31/64	0.484	12.3	SPECIAL		
E-2597	6	1/2	0.500	12.7	27/64	0.422	10.7	7/16	0.437	11.1	17/78	0.218	5.5	27/64	0.422	10.7	SPECIAL		
E-6209	6	21/32	0.656	16.7	15/32	0.469	11.9	5/8	0.625	15.9	7/32	0.210	5.3	15/32	0.469	11.9			
E-2499	5	17/32	0.531	13.5	15/32	0.469	11.9	3/8	0.375	9.5	7/32	0.219	5.6	11/32	0.344	8.7	SPECIAL		
E-1873	1	29/32	0.906	23.0	15/32	0.469	11.9	11/16	0.688	17.5	7/32	0.219	5.6	3/8	0.375	9.5			
E-205	1	7/8	0.875	22.2	7/16	0.438	11.1	3/4	0.750	19.1	7/32	0.219	5.6	3/8	0.375	9.5			
E-628	4	21/64	0.330	8.5	1/2	0.498	12.7	1/4	0.250	6.4	7/32	0.219	5.6	1/2	0.500	12.7			
E-2603	5	41/64	0.635	16.2	3/8	0.369	9.4	9/16	0.563	14.3	7/32	0.219	5.6	3/8	0.369	9.4			
E-2731	6	3/8	0.375	9.5	1/2	0.500	12.7	5/16	0.313	7.9	7/32	0.219	5.6	1/2	0.500	12.7			
E-2471	6	21/32	0.656	16.7	31/64	0.484	12.3	5/8	0.625	15.9	11/50	0.220	5.6	31/64	0.484	12.3	SPECIAL		
E-2468	6	27/32	0.844	21.4	31/64	0.484	12.3	25/32	0.781	19.8	3/13	0.230	5.8	31/64	0.484	12.3	SPECIAL		
E-2610	5	7/8	0.875	22.2	7/8	0.875	22.2	9/16	0.563	14.3	15/64	0.234	6.0	1/2	0.500	12.7	SPECIAL		
E-626	3	15/32	0.469	11.9	13/32	0.406	10.3	3/8	0.375	9.5	15/64	0.234	6.0	5/16	0.313	7.9			
E-6292	2	11/16	0.688	17.5	17/32	0.531	13.5	1/2	0.500	12.7	15/64	0.234	6.0	29/64	0.453	11.5			
E-6261	2	5/8	0.625	15.9	1/2	0.500	12.7	7/16	0.438	11.1	1/4	0.246	6.2	3/8	0.375	9.5			
E-2958	6	17/64	0.266	6.8	11/32	0.344	8.8	7/32	0.219	5.6	1/4	0.250	6.3	11/32	0.344	8.8			
E-1684	4	19/32	0.594	15.1	17/32	0.531	13.5	11/32	0.344	8.7	1/4	0.250	6.4	17/32	0.531	13.5			
E-635	2	13/16	0.813	20.6	5/8	0.625	15.9	19/32	0.594	15.1	1/4	0.250	6.4	1/2	0.500	12.7			
E-6207	5	3/8	0.375	9.5	3/8	0.375	9.5	9/32	0.281	7.1	1/4	0.250	6.4	3/8	0.375	9.5			
E-6293	2	11/16	0.688	17.5	17/32	0.531	13.5	1/2	0.500	12.7	17/64	0.266	6.7	29/64	0.453	11.5			
E-2596	6	69/94	0.734	18.6	1/2	0.495	12.6	16/25	0.640	16.3	3/11	0.272	6.9	1/2	0.495	12.6	SPECIAL		
E-2624	5	63/64	0.980	25.1	1/2	0.490	12.6	7/8	0.880	22.6	19/64	0.290	7.4	1/2	0.500	12.7			
E-2052	1	3/4	0.750	19.1	15/32	0.469	11.9	17/32	0.531	13.5	19/64	0.297	7.5	27/64	0.422	10.7			
E-6291	2	11/16	0.688	17.5	17/32	0.531	13.5	1/2	0.500	12.7	19/64	0.297	7.5	29/64	0.453	11.5			
E-1872	1	29/32	0.906	23.0	15/32	0.469	11.9	11/16	0.688	17.5	19/64	0.297	7.5	3/8	0.375	9.5			
E-633	4	3/8	0.375	9.5	7/16	0.438	11.1	1/4	0.250	6.4	5/16	0.313	7.9	7/16	0.438	11.1			
E-2473	6	1/2	0.500	12.7	7/8	0.875	22.2	1/4	0.250	6.4	5/16	0.313	7.9	27/32	0.844	21.4	SPECIAL		
E-629	2	11/16	0.688	17.5	17/32	0.531	13.5	1/2	0.500	12.7	21/64	0.328	8.3	29/64	0.453	11.5			
E-6251	7	5/8	0.625	15.9	5/8	0.625	15.9	1/2	0.500	12.7	21/64	0.328	8.3	15/32	0.469	11.9			
E-6224	7	7/16	0.438	11.1	5/8	0.625	15.9	5/16	0.313	7.9	21/64	0.328	8.3	1/2	0.500	12.7			
E-40140	2	11/16	0.688	17.4	17/32	0.531	13.6	1/2	0.500	12.7	21/64	0.328	8.4	29/64	0.453	11.6			

\* 5° taper on pin.



# END BUMPERS

By "D" Dimension



PART NO.	Fig No.	A			B			C			D			E			SPECIAL		
		Inch	Dec	MM	Inch	Dec	MM	Inch	Dec	MM	Inch	Dec	MM	Inch	Dec	MM			
E-658	6	3/10	0.300	7.6	5/8	0.625	15.9	2/9	0.228	5.8	1/3	0.335	8.5	5/8	0.625	15.9	SPECIAL		
E-636	7	1 1/8	1.125	28.6	9/16	0.563	14.3	1	1.000	25.4	11/32	0.344	8.7	1/2	0.500	12.7			
E-6252	7	5/8	0.625	15.9	5/8	0.625	15.9	1/2	0.500	12.7	3/8	0.375	9.5	15/32	0.469	11.9			
E-40100	7	5/8	0.625	15.8	5/8	0.625	15.8	1/2	0.500	12.7	3/8	0.375	9.5	15/32	0.469	12.0			
E-6253	1	5/8	0.625	15.9	1/2	0.500	12.7	1/2	0.500	12.7	3/8	0.375	9.5	1/2	0.500	12.7			
E-6301	1	11/16	0.688	17.5	19/32	0.594	15.1	9/16	0.563	14.3	13/32	0.406	10.2	33/64	0.516	13.1			
E-630	2	29/32	0.906	23.0	19/32	0.594	15.1	11/16	0.688	17.5	13/32	0.406	10.3	1/2	0.500	12.7			
E-1875	1	29/32	0.906	23.0	9/16	0.563	14.3	11/16	0.688	17.5	13/32	0.406	10.3	15/32	0.469	11.9			
E-6222	2	3/4	0.750	19.1	11/16	0.688	17.5	1/2	0.500	12.7	15/32	0.469	11.9	19/32	0.594	15.1			
E-622	2	3/4	0.750	19.1	23/32	0.725	18.5	1/2	0.500	12.7	1/2	0.500	12.7	5/8	0.625	15.9			
E-6223	2	7/8	0.875	22.2	13/16	0.813	20.6	39/64	0.605	15.4	9/16	0.563	14.3	11/16	0.688	17.5			
E-676	2	1	1.000	25.4	7/8	0.875	22.2	3/4	0.750	19.1	19/32	0.595	15.1	3/4	0.750	19.1			
E-673	2	1	1.000	25.4	7/8	0.875	22.2	3/4	0.750	19.1	5/8	0.625	15.9	3/4	0.750	19.1			
E-6751	2	7/8	0.875	22.2	1	1.000	25.4	5/8	0.625	15.9	23/32	0.718	18.2	7/8	0.875	22.2			
E-682	2	1 1/8	1.125	28.6	1 1/8	1.125	28.6	7/8	0.875	22.2	13/16	0.813	20.6	1	1.000	25.4			
E-6821	2	7/8	0.875	22.2	1 1/8	1.125	28.6	5/8	0.625	15.9	13/16	0.813	20.6	1	1.000	25.4			
E-680	2	7/8	0.875	22.2	1 1/4	1.250	31.8	3/4	0.750	19.1	15/16	0.938	23.8	1 1/8	1.125	28.6			
E-681	4	1 1/4	1.250	31.8	1 1/4	1.250	31.8	1 1/8	1.125	28.6	1	1.000	25.4	1 1/4	1.250	31.8			

End Bumpers are used on the ends of tubes for shock and vibration reduction and the smoothing of edges.

- ABS, Buna-N, Butyl, EPDM, Neoprene, Nitrite, Natural Rubber, Santoprene, Silicone, Viton.
- Multiple sizes / applications
- Custom end bumpers available

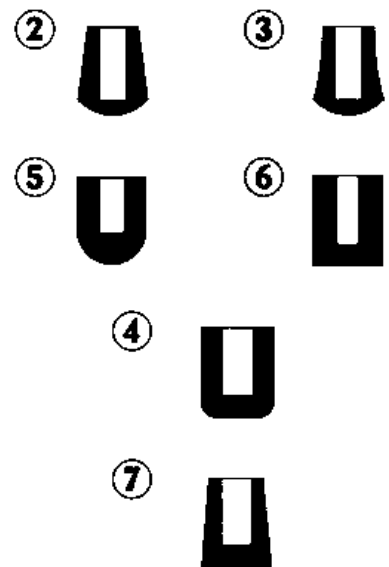
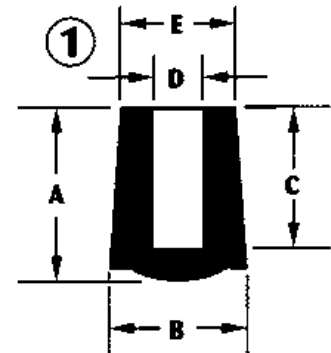

\* 5° taper on pin.





# MACHINE SCREW BUMPERS

By "B" Dimension

Machine screw bumpers are used to protect doors or truck bodies from damage. They are also used as feet for large vibrating equipment. Machine screw bumpers are a low cost way to provide a rubber break for many different applications. Great way to protect and isolate any two surfaces.

- Variety of styles, makes and models
- ABS, Acetal, Buna-N, Butyl, EPDM, Neoprene, Nitrite, Natural Rubber, Santoprene, Silicone, Viton.

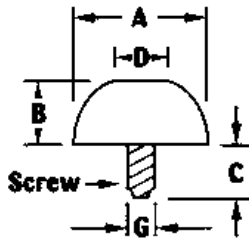

Fig. 2

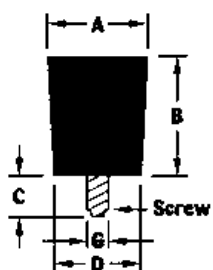

Fig. 3

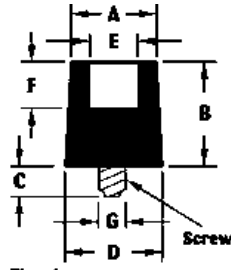

Fig. 4

PART NO.	Fig No.	A			B			C			D			E			F			G	
		Inch	Dec	MM	Inch	Dec	MM	Inch	Dec	MM	Inch	Dec	MM	Inch	Dec	MM	Inch	Dec	MM	Diam.	Screw
E-1155	2	1/2	0.500	12.7	5/32	0.156	4.0	7/32	0.219	5.6										0.125	*
E-MB-47	2	7/16	0.438	11.1	1/4	0.250	6.4	1/4	0.250	6.4										0.138	#6-32
E-MB-50	2	1/2	0.500	12.7	1/4	0.250	6.4	1/4	0.250	6.4	3/16	0.188	4.8							0.138	#6-32
E-MB-51	2	1/2	0.500	12.7	1/4	0.250	6.4	1/4	0.250	6.4	3/16	0.188	4.8							0.164	#8-32
E-MB-62	2	5/8	0.625	15.9	1/4	0.250	6.4	1/4	0.250	6.4	5/16	0.313	7.9							0.164	#8-32
E-MB-75	2	3/4	0.750	19.1	1/4	0.250	6.4	1/4	0.250	6.4	5/16	0.313	7.9							0.164	#8-32
E-827-S	2	7/16	0.438	11.1	1/4	0.250	6.4	1/4	0.250	6.4										0.138	#6-32
E-1443	4	11/32	0.344	8.7	1/4	0.250	6.4	1/2	0.500	12.7	11/32	0.344	8.7							0.138	#6-32
E-16	4	1/2	0.500	12.7	1/4	0.250	6.4	1/4	0.250	6.4	1/2	0.500	12.7							0.138	#6-32
E-827	2	7/16	0.438	11.1	1/4	0.250	6.4	7/32	0.219	5.6										0.125	*
E-3326S	4	11/32	0.344	8.7	5/16	0.313	7.9	1/2	0.500	12.7	23/64	0.366	9.3	5/32	0.156	4.0	5/32	0.156	4.0	0.138	#6-32
E-255	2	3/4	0.429	10.9	11/32	0.344	8.7	1/4	0.250	6.4										0.164	#8-32
E-3323S	3	7/8	0.875	22.2	13/32	0.406	10.3	3/8	0.375	9.5										0.190	#10-32
E-MB-87	2	7/8	0.875	22.2	7/16	0.438	11.1	1/2	0.500	12.7	7/16	0.438	11.1							0.190	#10-32
E-165	2	3/4	0.750	19.1	7/16	0.438	11.1	5/8	0.625	15.9	5/16	0.313	7.9							0.164	#8-32
E-165-A	2	3/4	0.750	19.1	7/16	0.438	11.1	3/8	0.375	9.5	5/16	0.313	7.9							0.164	#8-32
E-MB-100	2	1	1.000	25.4	1/2	0.500	12.7	1/2	0.500	12.7	1/2	0.500	12.7							0.190	#10-32
E-MB-112	2	1 1/8	1.125	28.6	1/2	0.500	12.7	1/2	0.500	12.7	3/8	0.375	9.5							0.190	#10-32
E-513	2	7/8	0.875	22.2	1/2	0.500	12.7	3/4	0.750	19.1	5/16	0.313	7.9							0.164	#8-32
E-513-A	2	7/8	0.875	22.2	1/2	0.500	12.7	3/8	0.375	9.5	5/16	0.313	7.9							0.164	#8-32
E-422	2	1	1.000	25.4	1/2	0.500	12.7	3/4	0.750	19.1	5/16	0.313	7.9							0.190	#10-32
E-422-A	2	1	1.000	25.4	1/2	0.500	12.7	3/8	0.375	9.5	5/16	0.313	7.9							0.190	#10-32
E-MB-103	3	1	1.000	25.4	5/8	0.625	15.9	1/4	0.250	6.4	5/8	0.625	15.9							0.138	#6-32
E-MB-104	3	1	1.000	25.4	5/8	0.625	15.9	1/4	0.250	6.4	5/8	0.625	15.9							0.166	#8-32
E-MB-63	4	9/16	0.563	14.3	5/8	0.625	15.9	1/4	0.250	6.4	5/8	0.625	15.9	5/16	0.313	7.9	5/16	0.313	7.9	0.164	#8-32
E-6070	3	1 5/8	1.625	41.3	1	1.000	25.4	3/4	0.750	19.1	1 11/32	1.344	34.1							0.310	#5/16-18

\* Knurled Stud Brass



# RECESSED BUMPERS

By "B" Dimension



PART NO.	Fig No.	A			B			C			D			E			F		
		Inch	Dec	MM	Inch	Dec	MM	Inch	Dec	MM	Inch	Dec	MM	Inch	Dec	MM	Inch	Dec	MM
E-2061*	2	7/16	0.438	11.1	5/32	0.156	4.0	3/32	0.094	2.4	1/16	0.063	1.6	1/4	0.250	6.4	5/32	0.156	4.0
E-206	2	3/8	0.375	9.5	3/16	0.188	4.8	3/32	0.094	2.4	3/32	0.094	2.4	3/16	0.188	4.8	5/64	0.078	2.0
E-2073*	5	1/2	0.500	12.7	3/16	0.188	4.8	3/32	0.094	2.4	3/32	0.094	2.4	7/32	0.219	5.6	1/8	0.125	3.2
E-1059	4	1/2	0.500	12.7	3/16	0.188	4.7	3/32	0.156	2.4	3/32	0.094	2.4	9/32	0.281	7.1	1/8	0.125	3.2
E-2075	5	1/2	0.500	12.7	7/32	0.219	4.8	5/32	0.156	3.2	1/16	0.063	1.6	9/32	0.275	7.0	1/8	0.130	3.3
E-164	3	15/16	0.938	23.8	1/4	0.250	6.4	1/8	0.125	3.2	1/8	0.125	3.2	1/2	0.500	12.7	1/4	0.250	6.4
E-207*	2	1/2	0.500	12.7	1/4	0.250	6.4	1/8	0.125	3.2	1/8	0.125	3.2	1/4	0.250	6.4	1/8	0.125	3.2
E-2062	1	3/8	0.375	9.5	1/4	0.250	6.4	3/16	0.188	4.8	1/16	0.063	1.6	1/4	0.250	6.4	3/32	0.094	2.4
E-2076*	5	1/2	0.500	12.7	1/4	0.250	6.4	3/16	0.188	4.8	1/16	0.063	1.6	15/64	0.234	6.0	1/8	0.125	3.2
E-2093*	5	5/8	0.625	15.9	1/4	0.250	6.4	1/8	0.125	3.2	1/8	0.125	3.2	3/8	0.375	9.5	3/16	0.188	4.8
E-2194	3	15/16	0.938	23.8	1/4	0.250	6.4	3/32	0.094	2.4	5/32	0.156	4.0	1/2	0.500	12.7	5/16	0.313	7.9
E-2195	3	15/16	0.938	23.8	1/4	0.250	6.4	1/8	0.125	3.2	1/8	0.125	3.2	1/2	0.500	12.7	1/4	0.250	6.4
E-2613	3	15/32	0.469	11.9	1/4	0.250	6.4	1/8	0.125	3.2	1/8	0.125	3.2	17/64	0.266	6.7	1/8	0.125	3.2
E-366	1	1/2	0.500	12.7	1/4	0.250	6.4	5/32	0.156	4.0	3/32	0.094	2.4	1/4	0.250	6.4	3/32	0.094	2.4
E-852	5	1/2	0.500	12.7	1/4	0.250	6.4	5/32	0.156	4.0	3/32	0.094	2.4	1/4	0.250	6.4	3/32	0.094	2.4
E-1308	1	1/2	0.500	12.7	1/4	0.250	6.4	5/32	0.156	4.0	3/32	0.094	2.4	1/4	0.250	6.4	1/8	0.125	3.2
E-2965*	5	9/16	0.560	14.2	17/64	0.260	6.6	5/32	0.150	3.8	3/32	0.110	2.3	11/32	0.340	8.6	5/32	0.160	4.1
E-2072	5	17/32	0.531	13.5	17/64	0.266	6.7	5/32	0.156	4.0	7/64	0.109	2.8	1/4	0.250	6.4	1/8	0.125	3.2
E-2087*	4	3/4	0.750	19.1	9/32	0.281	7.1	5/32	0.156	4.0	1/8	0.125	3.2	1/4	0.250	6.4	1/8	0.125	3.2
E-2092*	5	3/4	0.750	19.1	9/32	0.281	7.1	1/8	0.125	3.2	5/32	0.156	4.0	3/8	0.375	9.5	3/16	0.188	4.8
E-2588	5	3/4	0.750	19.1	9/32	0.281	7.1	3/16	0.187	4.7	3/32	0.094	2.4	16/31	0.516	13.1	4/23	0.174	4.4
E-2184*	1	3/4	0.750	19.1	19/64	0.297	7.5	3/16	0.188	4.8	7/64	0.109	2.8	11/32	0.344	8.7	1/8	0.125	3.2
E-2616*	5	3/4	0.750	19.1	5/16	0.312	8.0	5/32	0.160	4.1	5/32	0.152	3.9	3/8	0.375	9.5	5/32	0.156	4.0
E-208	2	5/8	0.625	15.9	5/16	0.313	7.9	3/16	0.188	4.8	1/8	0.125	3.2	1/4	0.250	6.4	3/32	0.094	2.4
E-2071*	5	1/2	0.500	12.7	5/16	0.313	7.9	3/16	0.188	4.8	1/8	0.125	3.2	1/4	0.250	6.4	5/32	0.156	4.0
E-2081*	2	5/8	0.625	15.9	5/16	0.313	7.9	3/16	0.188	4.8	1/8	0.125	3.2	1/4	0.250	6.4	3/16	0.188	4.8
E-2088*	2	5/8	0.625	15.9	5/16	0.313	7.9	3/16	0.188	4.8	1/8	0.125	3.2	1/4	0.250	6.4	1/8	0.125	3.2
E-2945*	5	1/2	0.500	12.7	11/32	0.344	8.8	3/16	0.188	4.7	5/32	0.156	4.0	1/4	0.250	6.3	1/8	0.125	3.1
E-2196	4	15/16	0.938	23.8	11/32	0.344	8.7	3/16	0.188	4.8	5/32	0.156	4.0	3/8	0.375	9.5	3/16	0.188	4.8

\* Can be supplied with steel washer inserts.

Recessed bumpers are used in a variety of applications, from doors, rubber feet for equipment and products, car hoods and doors, and more. A recessed area in the bumper allows for easy attachment via screw or other fastener.

ESTCO carries hundreds of recessed bumpers made from multiple materials, and we provide custom recessed bumpers as well.

- Variety of styles, makes and models
- Recessed center for screw or other fastener
- ABS, Acetal, Buna-N, Butyl, EPDM, Neoprene, Nitrite, Natural Rubber, Santoprene, Silicone, Viton.

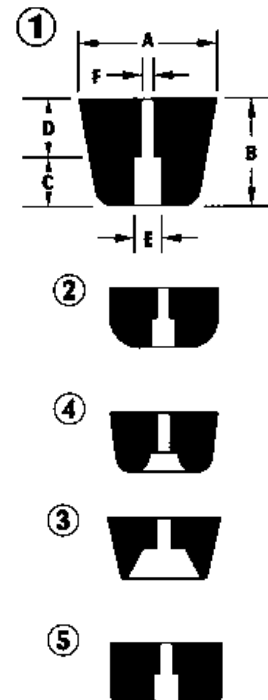



# RECESSED BUMPERS

By "B" Dimension

PART NO.	Fig No.	A			B			C			D			E			F		
		Inch	Dec	MM	Inch	Dec	MM	Inch	Dec	MM	Inch	Dec	MM	Inch	Dec	MM	Inch	Dec	MM
E-59	1	1	1.000	25.4	9/16	0.563	14.3	5/16	0.313	7.9	1/4	0.250	6.4	17/32	0.531	13.5	9/32	0.281	7.1
E-2090*	1	5/8	0.625	15.9	5/8	0.625	15.9	7/16	0.438	11.1	3/16	0.188	4.8	5/16	0.313	7.9	9/64	0.147	3.7
E-2096*	1	15/16	0.938	22.8	5/8	0.625	15.9	7/16	0.438	11.1	3/16	0.188	4.8	7/16	0.438	11.1	7/32	0.219	5.6
E-2803*	1	5/8	0.625	15.9	5/8	0.625	15.9	5/16	0.313	7.9	5/16	0.313	7.9	5/16	0.313	7.9	5/32	0.156	4.0
E-2808*	2	1 11/16	1.688	42.9	5/8	0.625	15.9	3/8	0.375	9.5	1/4	0.250	6.4	3/4	0.750	19.1	1/4	0.250	6.4
E-2809*	5	1 1/2	1.500	38.1	5/8	0.625	15.9	11/32	0.344	8.7	9/32	0.281	7.1	3/4	0.750	19.1	5/16	0.313	7.9
E-68*	1	1 3/32	1.094	27.8	5/8	0.625	15.9	13/32	0.406	10.3	7/32	0.219	5.6	7/16	0.438	11.1	3/16	0.188	4.7
E-1019-2*	1	1 1/2	1.500	38.1	5/8	0.625	15.9	11/32	0.344	8.7	9/32	0.281	7.1	3/4	0.750	19.1	5/16	0.313	7.9
E-1019*	1	1 1/2	1.500	38.1	5/8	0.625	15.9	11/32	0.344	8.7	9/32	0.281	7.1	1/2	0.500	12.7	3/16	0.188	4.7
E-2801*	5	5/8	0.625	15.9	3/4	0.750	19.1	15/32	0.469	11.9	9/32	0.281	7.1	11/32	0.344	8.7	11/64	0.172	4.4
E-2802*	1	5/8	0.625	15.9	3/4	0.750	19.1	1/4	0.250	6.4	1/2	0.500	12.7	5/16	0.313	7.9	11/64	0.165	4.2
E-2804*	5	5/8	0.625	15.9	3/4	0.750	19.1	5/16	0.313	7.9	7/16	0.438	11.1	5/16	0.313	7.9	5/32	0.156	4.0
E-2805*	5	5/8	0.625	15.9	3/4	0.750	19.1	5/16	0.313	7.9	7/16	0.438	11.1	5/16	0.313	7.9	11/64	0.172	4.4
E-2807*	5	5/8	0.625	15.9	3/4	0.750	19.1	1/4	0.250	6.4	1/2	0.500	12.7	5/16	0.313	7.9	5/32	0.156	4.0
E-2815*	4	3/4	0.750	19.1	3/4	0.750	19.1	17/32	0.531	13.5	7/32	0.219	5.6	13/32	0.406	10.3	5/32	0.156	4.0
E-2816*	5	5/8	0.625	15.9	3/4	0.750	19.1	9/32	0.281	7.2	31/64	0.484	12.4	21/64	0.328	8.3	11/64	0.175	4.4
E-40180*	5	5/8	0.625	15.9	3/4	0.750	19.0	15/64	0.234	5.9	33/64	0.516	13.1	5/16	0.313	7.9	5/32	0.156	4.0
E-1102*	5	1 1/2	1.500	38.1	3/4	0.750	19.1	1/2	0.500	12.7	1/4	0.250	6.4	15/32	0.469	11.9	1/4	0.250	6.4
E-2609*	5	3/4	0.750	19.1	49/64	0.770	19.7	15/64	0.230	5.9	35/64	0.540	13.8	5/16	0.313	8.0	1/8	0.125	3.2
E-2986*	5	13/16	0.813	20.6	13/16	0.813	20.7	7/16	0.438	11.1	3/8	0.375	9.5	15/32	0.469	11.9	1/4	0.250	6.4
E-197*	1	1	1.000	25.4	13/16	0.813	20.7	7/16	0.438	11.1	3/8	0.375	9.5	1/4	0.250	6.4	1/8	0.125	3.2
E-21*	5	13/16	0.813	20.7	13/16	0.813	20.7	7/16	0.438	11.1	3/8	0.375	9.5	15/32	0.469	11.9	1/4	0.250	6.4
E-2811*	5	15/16	0.938	23.8	15/16	0.938	23.8	9/16	0.563	14.3	3/8	0.375	9.5	3/8	0.375	9.5	3/16	0.188	4.8
E-2097*	1	1	1.000	25.4	1	1.000	25.4	5/8	0.625	15.9	3/8	0.375	9.5	5/16	0.313	7.9	5/32	0.156	4.0
E-2098*	5	1	1.000	25.4	1	1.000	25.4	9/16	0.563	14.3	7/16	0.438	11.1	3/8	0.375	9.5	13/64	0.203	5.1
E-2580*	2	1	1.000	25.4	1	1.000	25.4	5/8	0.625	15.9	3/8	0.375	9.5	5/16	0.313	7.9	5/32	0.156	4.0
E-40150	5	2 1/2	2.500	63.5	1	1.000	25.4	1/2	0.500	12.7	1/2	0.500	12.7	1 1/8	1.125	28.5	3/8	0.375	9.5
E-23*	1	1	1.000	25.4	1	1.000	25.4	5/8	0.625	15.9	3/8	0.375	9.5	5/16	0.313	7.9	5/32	0.156	4.0
E-613	4	2 1/2	2.500	63.5	1	1.000	25.4	1/2	0.500	12.7	1/2	0.500	12.7	1 1/8	1.125	28.6	3/8	0.375	9.5

\* Can be supplied with steel washer inserts.

Recessed bumpers are used in a variety of applications, from doors, rubber feet for equipment and products, car hoods and doors, and more. A recessed area in the bumper allows for easy attachment via screw or other fastener.

ESTCO carries hundreds of recessed bumpers made from multiple materials, and we provide custom recessed bumpers as well.

- Variety of styles, makes and models
- Recessed center for screw or other fastener
- ABS, Acetal, Buna-N, Butyl, EPDM, Neoprene, Nitrite, Natural Rubber, Santoprene, Silicone, Viton.

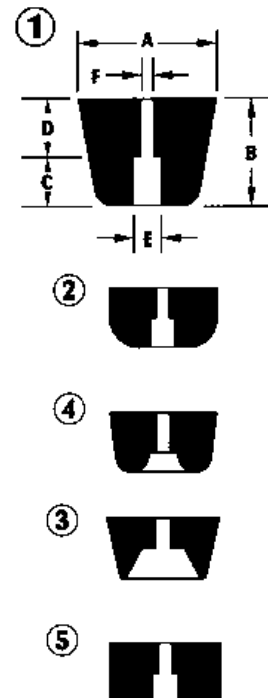



# RECESSED BUMPERS

By "B" Dimension

Recessed bumpers are used in a variety of applications, from doors, rubber feet for equipment and products, car hoods and doors, and more. A recessed area in the bumper allows for easy attachment via screw or other fastener.

ESTCO carries hundreds of recessed bumpers made from multiple materials, and we provide custom recessed bumpers as well.

- Variety of styles, makes and models
- Recessed center for screw or other fastener
- ABS, Acetal, Buna-N, Butyl, EPDM, Neoprene, Nitrite, Natural Rubber, Santoprene, Silicone, Viton.

PART NO.	Fig No.	A			B			C			D			E			F		
		Inch	Dec	MM	Inch	Dec	MM	Inch	Dec	MM	Inch	Dec	MM	Inch	Dec	MM	Inch	Dec	MM
E-2812*	5	1	1.000	25.4	1 1/4	1.250	31.8	5/8	0.625	15.9	5/8	0.625	16.0	1/4	0.250	6.4	1/8	0.125	3.2
E-2990*	5	1 1/4	1.250	31.8	1 1/4	1.250	31.8	3/4	0.750	19.1	1/2	0.500	12.7	3/8	0.375	9.5	1/4	0.250	6.4
E-1326	5	1 1/4	1.250	31.8	1 1/4	1.250	31.8	3/4	0.750	19.1	1/2	0.500	12.7	3/8	0.375	9.5	1/4	0.250	6.4
E-2099*	2	1	1.000	25.4	1 1/2	1.500	38.1	5/8	0.625	15.9	7/8	0.875	22.2	5/16	0.313	7.9	5/32	0.156	4.0
E-3311	5	1 1/4	1.250	31.8	1 7/8	1.875	47.6	3/4	0.750	19.1	1 1/8	1.125	28.6	3/8	0.375	9.5	1/4	0.250	6.4
E-1487	5	1 1/4	1.250	31.8	1 7/8	1.875	47.6	3/4	0.750	19.1	1 1/2	1.500	38.1	3/8	0.250	6.4	1/4	0.250	6.4
E-2199*	1	1	1.000	25.4	2 1/4	2.250	57.2	1 3/8	1.375	34.9	7/8	0.875	22.2	5/16	0.313	7.9	5/32	0.156	4.0

\* Can be supplied with steel washer inserts.

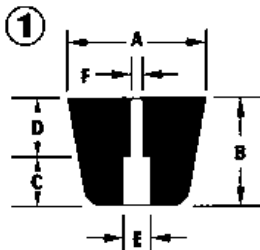

ISO 9001 Certified  
CERTIFICATE # 08-511

# HEYCO® RUBBER PUSH-IN BUMPERS



PANEL DIMENSIONS				PART NO.	DESCRIPTION	PART DIMENSIONS								TYPE
Maximum Thickness		Mounting Hole Diameter				A Base Diameter		B Base Height		C Insert Diameter		D Insert Height		
in.	mm.	in.	mm.			in.	mm.	in.	mm.	in.	mm.	in.	mm.	
.098	2,5	.118	3,0	<b>H-G2000</b>	RGB 118-236-4	.236	6,0	.118	3,0	.196	5,0	.472	12,0	T
.071	1,8	.125	3,2	<b>H-G2002</b>	RGB 125-334-6	.334	8,5	.189	4,9	.295	7,5	.429	10,9	T
.031	0,8	.156	4,0	<b>H-G2004</b>	RGB156-375-3	.375	9,5	.093	2,4	.218	5,5	.109	2,8	F
.059	1,5	.177	4,5	<b>H-G2006</b>	RGB 177-334-9	.334	8,5	.295	7,5	.236	6,0	.729	18,5	T
.109	2,8	.180	4,6	<b>H-G2007</b>	RGB 180-500-2	.500	12,7	.060	1,5	.250	6,4	.078	2,0	F
.047	1,2	.187	4,7	<b>H-G2009</b>	RGB 187-250-6	.250	6,4	.187	4,7	.031	0,8	.343	8,7	F
.047	1,2	.187	4,7	<b>H-G2010</b>	RGB 187-312-4	.312	7,9	.125	3,2	.250	6,4	.093	2,4	F
.050	1,3	.187	4,7	<b>H-G2011</b>	RGB 187-375-8	.375	9,5	.250	6,4	.250	6,4	.093	2,4	F
.062	1,6	.187	4,7	<b>H-G2012</b>	RGB 187-375-4	.375	9,5	.125	3,2	.250	6,4	.125	3,2	F
.062	1,6	.187	4,7	<b>H-G2013</b>	RGB 187-500-3	.500	12,7	.093	2,4	.250	6,4	.187	4,7	F
.078	2,0	.187	4,7	<b>H-G2014</b>	RGB 187-338-6	.338	8,6	.172	4,4	.250	6,4	.296	7,5	F
.093	2,4	.218	5,5	<b>H-G2016</b>	RGB 218-406-6	.406	10,3	.187	4,7	.281	7,1	.093	2,4	D
.125	3,2	.218	5,5	<b>H-G2017</b>	RGB 218-875-6	.875	22,2	.171	4,3	.343	8,7	.484	12,3	T
.047	1,2	.250	6,4	<b>H-G2019</b>	RGB 250-437-6	.437	11,1	.187	4,7	.312	7,9	.125	3,2	F
.047	1,2	.250	6,4	<b>H-G2020</b>	RGB 250-500-6	.500	12,7	.171	4,3	.312	7,9	.187	4,7	D
.050	1,3	.250	6,4	<b>H-G2021</b>	RGB 250-562-12	.562	14,3	.375	9,5	.340	8,6	.265	6,7	F
.062	1,6	.250	6,4	<b>H-G2022</b>	RGB 250-375-4	.375	9,5	.125	3,2	.312	7,9	.062	1,6	F
.062	1,6	.250	6,4	<b>H-G2023</b>	RGB250-375-4R	.375	9,5	.125	3,2	.312	7,9	.062	1,6	F
.062	1,6	.250	6,4	<b>H-G2024</b>	RGB 250-500-5	.500	12,7	.156	4,0	.312	7,9	.125	3,2	F
.062	1,6	.250	6,4	<b>H-G2025</b>	RGB 250-500-8	.500	12,7	.250	6,4	.312	7,9	.125	3,2	F
.125	3,2	.250	6,4	<b>H-G2026</b>	RGB 250-406-7	.406	10,3	.218	5,5	.343	8,7	.062	1,6	F
.125	3,2	.250	6,4	<b>H-G2027</b>	RGB 250-562-4	.562	14,3	.125	3,2	.343	8,7	.125	3,2	F
.047	1,2	.281	7,1	<b>H-G2029</b>	RGB 281-500-2	.500	12,7	.062	1,6	.375	9,5	.156	4,0	F
.047	1,2	.281	7,1	<b>H-G2030</b>	RGB 281-500-4	.500	12,7	.125	3,2	.375	9,5	.156	4,0	F
.078	2,0	.281	7,1	<b>H-G2031</b>	RGB 281-562-4	.562	14,3	.125	3,2	.375	9,5	.156	4,0	F
.125	3,2	.281	7,1	<b>H-G2032</b>	RGB 281-625-11	.625	15,9	.343	8,7	.437	11,1	.171	4,3	F
.047	1,2	.312	7,9	<b>H-G2034</b>	RGB 312-1250-3	.250	28,6	.093	2,4	.437	11,1	.078	2,0	F
.062	1,6	.312	7,9	<b>H-G2035</b>	RGB 312-375-5	.375	9,5	.156	4,0	.375	9,5	.156	4,0	D
.078	2,0	.312	7,9	<b>H-G2036</b>	RGB 312-875-4	.875	22,2	.125	3,2	.500	12,7	.062	1,6	F
.093	2,4	.312	7,9	<b>H-G2037</b>	RGB 312-625-8	.625	15,9	.250	6,4	.375	9,5	.125	3,2	F
.094	2,4	.328	8,3	<b>H-G2039</b>	RGB 328-846-6	.846	21,5	.187	4,7	.421	10,7	.265	6,7	D
.125	3,2	.375	9,5	<b>H-G2041</b>	RGB 375-765-24	.765	19,4	.750	19,1	.500	12,7	.125	3,2	C
.125	3,2	.500	12,7	<b>H-G2043</b>	RGB 500-1000-6	1.000	25,4	.187	4,7	.625	15,9	.125	3,2	D
.188	4,8	.500	12,7	<b>H-G2044</b>	RGB 500-1000-10	1.000	25,4	.312	7,9	.687	17,4	.187	4,7	F

- Rubber bumpers are designed for through hole protection.
- Designed to fit snugly into your opening and not let air, water, etc. pass through.
- Can also be used as feet.
- Rubber bumpers are constructed of SBR with an operating temperature of -40°F (-40°C) to 221°F (105°C).

Standard color black.

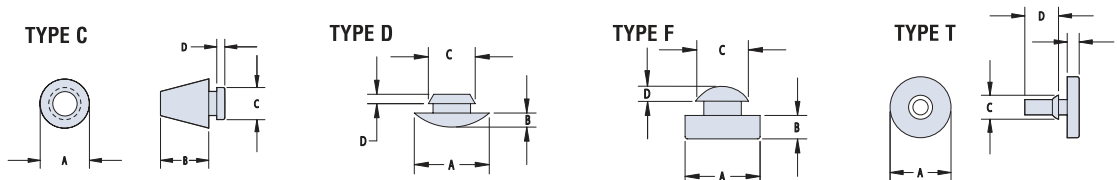



# STEM BUMPERS

By "E" Dimension

Stem bumpers are typically used as hole plugs or insertable bumpers for vibration and noise reduction.

ESTCO carries hundreds of stem bumpers made from multiple materials, and we provide custom recessed bumpers as well.

- Push in: no screws or fasteners required.
- Used for noise reduction and vibration and shock absorption, and hole plugs.
- ABS, Acetal, Buna-N, Butyl, EPDM, Neoprene, Nitrite, Natural Rubber, Santoprene, Silicone, Viton.

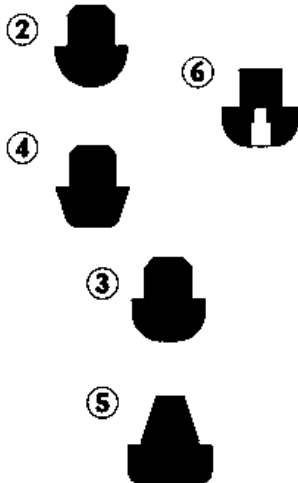
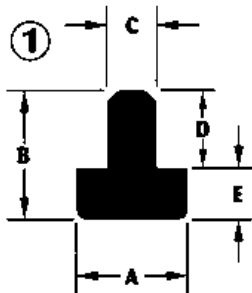

PART NO.	Fig No.	A			B			C			D			E		
		Inch	Dec	MM	Inch	Dec	MM	Inch	Dec	MM	Inch	Dec	MM	Inch	Dec	MM
E-6136	1	3/8	0.375	9.5	9/32	0.275	7.0	3/16	0.188	4.8	1/4	0.250	6.4	1/32	0.025	0.6
E-2677**	S	3/16	0.188	4.7	1/4	0.250	6.3	1/8	0.130	3.3	7/32	0.218	5.6	1/32	0.031	0.8
E-6135	1	1/2	0.500	12.7	1/4	0.250	6.4	3/16	0.188	4.8	7/32	0.218	5.6	1/32	0.031	0.8
E-602	1	3/16	0.188	4.8	9/64	0.134	3.4	1/8	0.125	3.2	3/32	0.094	2.4	3/64	0.040	1.0
E-6025	3	7/32	0.219	5.6	1/4	0.250	6.4	11/64	0.170	4.3	13/64	0.203	5.2	3/64	0.047	1.2
E-3309	1	1/2	0.500	12.7	5/16	0.312	7.9	3/16	0.188	4.8	1/4	0.250	6.4	1/16	0.062	1.6
E-2976	1	3/8	0.375	9.5	5/16	0.313	7.9	3/16	0.188	4.8	1/4	0.250	6.4	1/16	0.063	1.6
E-6012	1	1/4	0.250	6.4	3/16	0.188	4.8	11/64	0.172	4.4	1/8	0.125	3.2	1/16	0.063	1.6
E-6034	2	1/2	0.500	12.7	3/8	0.375	9.5	13/64	0.196	5.0	5/16	0.313	7.9	1/16	0.063	1.6
E-6053*	1	3/8	0.375	9.5	15/64	0.234	6.0	15/64	0.234	6.0	11/64	0.172	4.4	1/16	0.063	1.6
E-6072	1	1/2	0.500	12.7	5/16	0.313	7.9	3/8	0.375	9.5	1/4	0.250	6.4	1/16	0.063	1.6
E-6073	5	1/2	0.500	12.7	5/16	0.313	7.9	15/64	0.234	6.0	1/4	0.250	6.4	1/16	0.063	1.6
E-6086	1	15/32	0.469	11.9	7/16	0.438	11.1	3/8	0.375	9.5	3/8	0.375	9.5	1/16	0.063	1.6
E-6234	2	1/2	0.500	12.7	3/8	0.375	9.5	13/64	0.196	5.0	5/16	0.313	7.9	1/16	0.063	1.6
E-2645	1	15/64	0.234	6.0	9/32	0.281	7.1	9/64	0.140	3.6	7/32	0.219	5.6	1/16	0.063	1.6
E-6178*	1	1/2	0.500	12.7	13/64	0.195	5.0	3/16	0.180	4.6	1/8	0.130	3.3	1/16	0.065	1.7
E-6186	1	15/32	0.469	11.9	39/64	0.600	15.2	3/8	0.375	9.5	17/32	0.530	13.5	5/64	0.070	1.8
E-6045	1	3/8	0.375	9.5	17/64	0.266	6.8	15/64	0.234	6.0	3/16	0.188	4.8	5/64	0.078	2.0
E-6134	3	1/2	0.500	12.7	25/64	0.391	9.9	13/64	0.196	5.0	1/4	0.250	6.4	5/64	0.078	2.0
E-6137	1	1/2	0.500	12.7	21/64	0.328	8.3	3/16	0.188	4.8	1/4	0.250	6.4	5/64	0.078	2.0
E-6170	5	1/2	0.500	12.7	21/64	0.328	8.3	1/4	0.250	6.4	1/4	0.250	6.4	5/64	0.078	2.0
E-6172	1	1/2	0.500	12.7	25/64	0.391	9.9	1/4	0.250	6.4	5/16	0.313	7.9	5/64	0.078	2.0
E-6041	1	3/8	0.375	9.5	17/64	0.266	6.8	13/64	0.196	5.0	3/16	0.188	4.8	5/64	0.078	2.0
E-2570-B**	2	5/16	0.313	7.9	29/50	0.580	14.7	1/4	0.250	6.4	1/2	0.500	12.7	2/25	0.080	2.0
E-6023	5	17/64	0.266	6.7	13/32	0.406	10.3	5/32	0.150	3.8	5/16	0.313	7.9	3/32	0.094	2.4
E-6048	1	3/8	0.375	9.5	9/32	0.281	7.1	13/64	0.200	5.1	3/16	0.188	4.8	3/32	0.094	2.4
E-6075	1	1/2	0.500	12.7	9/32	0.281	7.1	1/4	0.250	6.4	3/16	0.188	4.8	3/32	0.094	2.4
E-6123	5	17/64	0.266	6.7	13/32	0.406	10.3	9/64	0.140	3.6	5/16	0.313	7.9	3/32	0.094	2.4
E-6174	1	1/2	0.500	12.7	11/32	0.344	8.7	3/16	0.188	4.8	1/4	0.250	6.4	3/32	0.094	2.4

\* Indicates inserting hole in base and stem. \*\* See Molded Parts of Irregular Design "Custom Molded Parts" section.

# STEM BUMPERS

By "E" Dimension



PART NO.	Fig No.	A			B			C			D			E		
		Inch	Dec	MM	Inch	Dec	MM	Inch	Dec	MM	Inch	Dec	MM	Inch	Dec	MM
E-2975	1	7/16	0.438	11.1	11/32	0.344	8.7	1/4	0.250	6.4	1/4	0.250	6.4	3/32	0.094	2.4
E-6026*	2	23/64	0.350	8.9	15/32	0.470	11.9	3/16	0.190	4.8	3/8	0.370	9.4	3/32	0.100	2.5
E-6092	1	5/8	0.625	15.9	27/64	0.422	10.7	31/64	0.483	12.3	5/16	0.313	7.9	7/64	0.109	2.8
E-653	1	13/64	0.196	5.0	11/64	0.172	4.4	1/8	0.130	3.3	1/16	0.063	1.6	7/64	0.109	2.8
E-2643	1	5/8	0.625	15.9	11/32	0.344	8.7	17/64	0.266	6.8	15/64	0.234	6.0	7/64	0.109	2.8
E-3360	1	3/8	0.380	9.7	15/64	0.240	6.1	1/8	0.127	3.2	1/8	0.120	3.0	1/8	0.120	3.0
E-601	2	1/4	0.250	6.4	7/32	0.219	5.6	1/8	0.125	3.2	3/32	0.094	2.4	1/8	0.125	3.2
E-604	3	3/8	0.375	9.5	5/16	0.313	7.9	13/64	0.196	5.0	3/16	0.188	4.8	1/8	0.125	3.2
E-607	1	1/2	0.500	12.7	7/16	0.438	11.1	5/16	0.313	7.9	5/16	0.313	7.9	1/8	0.125	3.2
E-6011	2	1/4	0.250	6.4	5/16	0.313	7.9	1/8	0.125	3.2	3/16	0.188	4.8	1/8	0.125	3.2
E-6043	3	3/8	0.375	9.5	1/4	0.250	6.4	13/64	0.196	5.0	1/8	0.125	3.2	1/8	0.125	3.2
E-6049	1	3/8	0.375	9.5	19/64	0.297	7.5	13/64	0.197	5.0	11/64	0.172	4.4	1/8	0.125	3.2
E-6052*	2	3/8	0.375	9.5	3/8	0.375	9.5	3/16	0.188	5.0	1/4	0.250	6.4	1/8	0.125	3.2
E-6066*	2	7/16	0.438	11.1	1/4	0.250	6.4	5/16	0.313	7.9	1/8	0.125	3.2	1/8	0.125	3.2
E-6067	1	7/16	0.438	11.1	3/8	0.375	9.5	1/4	0.250	6.4	1/4	0.250	6.4	1/8	0.125	3.2
E-6071	1	1/2	0.500	12.7	15/32	0.469	12.7	1/4	0.250	6.4	11/32	0.336	8.7	1/8	0.125	3.2
E-6078	5	1/2	0.500	12.7	3/8	0.375	9.7	15/64	0.234	6.0	1/4	0.250	6.4	1/8	0.125	3.2
E-6079	1	1/2	0.500	12.7	7/16	0.438	11.1	19/64	0.297	7.5	5/16	0.313	7.9	1/8	0.125	3.2
E-6084*	1	7/16	0.438	11.1	11/32	0.344	8.7	9/32	0.281	7.1	7/32	0.219	5.6	1/8	0.125	3.2
E-6085	1	27/64	0.422	10.7	5/16	0.313	7.9	17/64	0.260	6.6	3/16	0.188	4.8	1/8	0.125	3.2
E-6091	5	5/8	0.625	15.9	1/2	0.500	12.7	1/2	0.507	12.9	3/8	0.375	9.5	1/8	0.125	3.2
E-6097	1	9/16	0.563	14.3	27/64	0.422	10.7	7/16	0.438	11.1	19/64	0.297	7.5	1/8	0.125	3.2
E-6171*	1	1/2	0.500	12.7	3/8	0.375	9.5	1/4	0.250	6.4	1/4	0.250	6.4	1/8	0.125	3.2
E-6177	5	1/2	0.500	12.7	15/32	0.469	11.9	9/32	0.289	7.3	11/32	0.344	8.7	1/8	0.125	3.2
E-6179*	1	1/2	0.500	12.7	5/16	0.313	7.9	17/64	0.266	6.8	3/16	0.188	4.8	1/8	0.125	3.2
E-6076	1	15/32	0.469	11.9	29/64	0.453	11.5	5/16	0.313	7.9	5/16	0.313	7.9	9/64	0.141	3.6
E-605	2	3/8	0.375	9.5	13/32	0.406	10.3	9/32	0.281	7.1	1/4	0.250	6.4	5/32	0.156	4.0
E-6035*	3	9/16	0.563	14.3	9/32	0.281	7.1	7/16	0.438	11.1	1/8	0.125	3.2	5/32	0.156	4.0
E-6046	1	3/8	0.375	9.5	11/32	0.344	8.7	3/16	0.188	4.8	3/16	0.188	4.8	5/32	0.156	4.0
E-6047*	1	3/8	0.375	9.5	1/2	0.500	12.7	19/64	0.302	7.7	11/32	0.344	8.7	5/32	0.156	4.0
E-6051	2	3/8	0.375	9.5	7/16	0.438	11.1	1/4	0.250	6.4	9/32	0.281	7.1	5/32	0.156	4.0
E-6077	5	1/2	0.500	12.7	1/2	0.500	12.7	9/32	0.289	7.3	11/32	0.344	8.7	5/32	0.156	4.0
E-6087	1	7/16	0.438	11.1	11/32	0.344	8.7	1/4	0.250	6.4	3/16	0.188	4.8	5/32	0.156	4.0
E-2646	2	5/16	0.312	8.0	11/32	0.344	8.7	3/16	0.190	4.9	3/16	0.187	4.8	5/32	0.156	4.0
E-6065	2	27/64	0.422	10.7	27/64	0.422	10.7	1/4	0.250	6.4	1/4	0.250	6.4	11/64	0.172	4.4
E-506	6	3/8	0.375	9.5	3/8	0.375	9.5	3/16	0.188	4.8	3/16	0.188	4.8	3/16	0.188	4.8
E-603	3	1/2	0.500	12.7	5/16	0.313	7.9	1/4	0.250	6.4	1/8	0.125	3.2	3/16	0.188	4.8
E-606	2	7/16	0.438	11.1	5/16	0.313	7.9	3/16	0.188	4.8	1/8	0.125	3.2	3/16	0.188	4.8

Stem bumpers are typically used as hole plugs or insertable bumpers for vibration and noise reduction.

ESTCO carries hundreds of stem bumpers made from multiple materials, and we provide custom recessed bumpers as well.

- Push in: no screws or fasteners required.
- Used for noise reduction and vibration and shock absorption, and hole plugs.
- ABS, Acetal, Buna-N, Butyl, EPDM, Neoprene, Nitrite, Natural Rubber, Santoprene, Silicone, Viton.

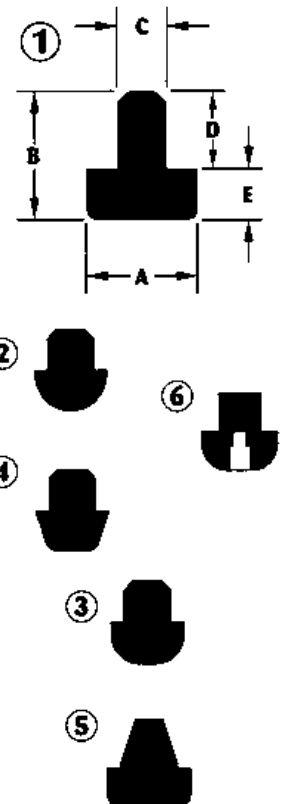

\* Indicates inserting hole in base and stem. \*\* See Molded Parts of Irregular Design "Custom Molded Parts" section.





# STEM BUMPERS

By "E" Dimension

Stem bumpers are typically used as hole plugs or insertable bumpers for vibration and noise reduction.

ESTCO carries hundreds of stem bumpers made from multiple materials, and we provide custom recessed bumpers as well.

- Push in: no screws or fasteners required.
- Used for noise reduction and vibration and shock absorption, and hole plugs.
- ABS, Acetal, Buna-N, Butyl, EPDM, Neoprene, Nitrite, Natural Rubber, Santoprene, Silicone, Viton.

PART NO.	Fig No.	A			B			C			D			E					
		Inch	Dec	MM	Inch	Dec	MM	Inch	Dec	MM	Inch	Dec	MM	Inch	Dec	MM			
E-608*	3	7/16	0.438	11.1	1/2	0.500	12.7	5/16	0.313	7.9	5/16	0.313	7.9	3/16	0.188	4.8			
E-6031	2	1/2	0.500	12.7	5/16	0.313	7.9	13/64	0.203	5.2	1/8	0.125	3.2	3/16	0.188	4.8			
E-6061	2	7/16	0.438	11.1	5/16	0.313	7.9	7/32	0.219	5.6	1/8	0.125	3.2	3/16	0.188	4.8			
E-6062	2	7/16	0.438	11.1	7/16	0.438	11.1	1/4	0.250	6.4	1/4	0.250	6.4	3/16	0.188	4.8			
E-6063	2	7/16	0.438	11.1	5/16	0.313	7.9	15/64	0.238	6.0	1/8	0.125	3.2	3/16	0.188	4.8			
E-6064†	2	7/16	0.438	11.1	7/16	0.438	11.1	1/4	0.250	6.4	1/4	0.250	6.4	3/16	0.188	4.8			
E-6081*	1	1/2	0.500	12.7	7/16	0.438	11.1	3/8	0.375	9.5	1/4	0.250	6.4	3/16	0.188	4.8			
E-6082*	1	1/2	0.500	12.7	3/8	0.375	9.5	3/8	0.375	9.5	3/16	0.188	4.8	3/16	0.188	4.8			
E-6083*	1	7/16	0.438	11.1	5/16	0.313	7.9	5/16	0.313	7.9	1/8	0.125	3.2	3/16	0.188	4.8			
E-6173	1	1/2	0.500	12.7	9/16	0.563	14.3	3/8	0.375	9.5	3/8	0.375	9.5	3/16	0.188	4.8			
E-2652	1	7/8	0.875	22.2	9/16	0.563	14.3	1/2	0.500	12.7	3/8	0.375	9.5	3/16	0.188	4.8			
E-609	1	5/8	0.625	15.9	19/32	0.594	15.1	7/16	0.443	11.3	3/8	0.375	9.5	7/32	0.219	5.6			
E-6093*	1	5/8	0.625	15.9	19/32	0.594	15.1	7/16	0.443	11.3	3/8	0.375	9.5	7/32	0.219	5.6			
E-6180	1	5/8	0.625	15.9	23/32	0.719	18.3	7/16	0.438	11.3	1/2	0.500	12.7	7/32	0.219	5.6			
E-507	6	1/2	0.500	12.7	13/32	0.402	10.2	1/4	0.250	6.4	3/16	0.188	4.8	7/32	0.215	5.4			
E-5071	6	1/2	0.500	12.7	13/32	0.412	10.4	9/32	0.281	7.1	3/16	0.188	4.8	7/32	0.215	5.4			
E-610	3	11/16	0.688	17.5	19/32	0.594	15.9	17/32	0.531	13.5	11/32	0.344	9.5	1/4	0.250	6.4			
E-671	4	15/32	0.469	11.9	11/16	0.688	17.5	3/8	0.375	9.5	7/16	0.438	11.1	1/4	0.250	6.4			
E-6032	2	1/2	0.500	12.7	11/16	0.688	17.5	7/16	0.438	11.1	7/16	0.438	11.1	1/4	0.250	6.4			
E-6033	2	1/2	0.500	12.7	11/16	0.688	17.5	13/32	0.406	10.3	7/16	0.438	11.1	1/4	0.250	6.4			
E-6042	3	3/8	0.375	9.5	7/16	0.438	11.1	13/64	0.196	5.0	3/16	0.188	4.8	1/4	0.250	6.4			
E-6044	4	3/8	0.375	9.5	9/16	0.563	14.3	13/64	0.196	5.0	5/16	0.313	7.9	1/4	0.250	6.4			
E-6095*	1	5/8	0.625	15.9	5/8	0.625	15.9	3/8	0.375	9.5	3/8	0.375	9.5	1/4	0.250	6.4			
E-6102	3	11/16	0.688	17.5	5/8	0.625	15.9	9/16	0.563	14.3	3/8	0.362	9.5	1/4	0.250	6.4			
E-6103	3	11/16	0.688	17.5	5/8	0.625	15.9	39/64	0.605	15.4	3/8	0.375	9.5	1/4	0.250	6.4			
E-2570-A**	2	5/16	0.313	7.9	3/4	0.750	19.1	1/4	0.250	6.4	1/2	0.500	12.7	1/4	0.250	6.4			
E-2656	4	3/8	0.375	9.5	9/16	0.563	14.3	3/16	0.188	4.8	9/32	0.281	7.1	9/32	0.281	7.1			
E-613	3	5/8	0.625	15.9	23/32	0.719	18.3	7/16	0.438	11.1	7/16	0.438	11.1	9/32	0.281	7.1			
E-6131	3	5/8	0.625	15.9	23/32	0.719	18.3	Note 1			7/16	0.438	11.1	9/32	0.281	7.1			

\* Indicates inserting hole in base and stem. \*\* See Molded Parts of Irregular Design "Custom Molded Parts" section. Note 1 - Tapered .400" to .435". † Same as 6062 except 1/16" hole in shank.

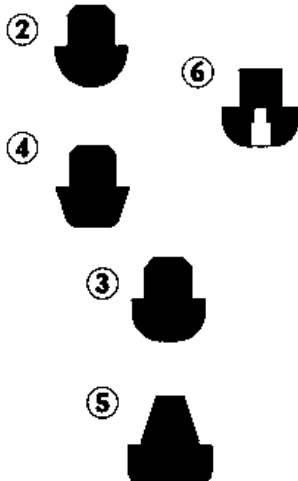
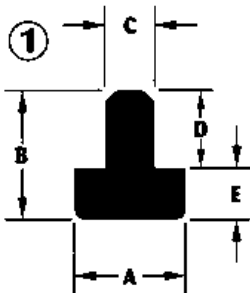



# STEM BUMPERS

By "E" Dimension



PART NO.	Fig No.	A			B			C			D			E				
		Inch	Dec	MM	Inch	Dec	MM	Inch	Dec	MM	Inch	Dec	MM	Inch	Dec	MM		
E-6132	3	5/8	0.625	15.9	23/32	0.719	18.3	Note 2			7/16	0.438	11.1	9/32	0.281	7.1		
E-614	2	5/8	0.625	15.9	5/8	0.625	15.9	Note 3			5/16	0.313	7.9	5/16	0.313	7.9		
E-2992	2	5/8	0.625	15.9	9/16	0.563	14.3	5/16	0.313	7.9	1/4	0.250	6.4	5/16	0.313	7.9		
E-6133	3	5/8	0.625	15.9	29/32	0.906	23.0	9/16	0.557	14.1	19/32	0.594	15.1	5/16	0.313	7.9		
E-6080	4	1/2	0.500	12.7	41/64	0.641	16.3	3/16	0.188	4.8	5/16	0.313	7.9	21/64	0.328	8.3		
E-6139	4	39/64	0.609	15.5	11/16	0.688	17.5	3/8	0.380	9.7	11/32	0.344	8.7	11/32	0.344	8.7		
E-2451	1	2 3/16	2.188	55.6	1 1/16	1.063	27.0	1 3/4	1.750	44.5	23/32	0.719	18.3	11/32	0.344	8.7		
E-612	2	13/16	0.813	20.6	7/8	0.875	22.2	11/16	0.688	17.5	1/2	0.500	12.7	3/8	0.375	9.5		
E-6101	3	11/16	0.688	17.5	3/4	0.750	19.1	17/32	0.531	13.5	3/8	0.375	9.5	3/8	0.375	9.5		
E-6121	2	13/16	0.813	20.6	1	1.000	25.4	9/16	0.563	14.3	5/8	0.625	15.9	3/8	0.375	9.5		
E-6122	2	13/16	0.813	20.6	7/8	0.875	22.2	21/32	0.656	16.7	1/2	0.500	12.7	3/8	0.375	9.5		
E-2980	2	3/4	0.750	19.1	3/4	0.750	19.1	3/8	0.375	9.5	3/8	0.375	9.5	3/8	0.375	9.5		
E-3333	2	94/97	0.969	24.6	1 1/16	1.062	27.0	17/50	0.340	8.6	5/8	0.625	15.9	7/16	0.437	11.1		
E-6088	1	5/8	0.625	15.9	15/16	0.938	23.8	7/16	0.438	11.1	1/2	0.500	12.7	7/16	0.438	11.1		
E-6089	1	7/16	0.438	11.1	15/16	0.938	23.8	5/16	0.313	7.9	1/2	0.500	12.7	7/16	0.438	11.1		
E-6167	1	7/16	0.438	11.1	31/32	0.969	24.6	1/4	0.250	6.4	1/2	0.500	12.7	15/32	0.469	11.9		
E-6096	4	5/8	0.625	15.9	15/16	0.938	23.8	5/16	0.313	7.9	7/16	0.438	11.1	1/2	0.500	12.7		

\* Indicates inserting hole in base and stem. \*\* See Molded Parts of Irregular Design \*Custom Molded Parts\* section. Note 2 - Tapered .520" to .535". Note 3 - Tapered 27/64 to 29/64.

Stem bumpers are typically used as hole plugs or insertable bumpers for vibration and noise reduction.

ESTCO carries hundreds of stem bumpers made from multiple materials, and we provide custom recessed bumpers as well.

- Push in: no screws or fasteners required.
- Used for noise reduction and vibration and shock absorption, and hole plugs.
- ABS, Acetal, Buna-N, Butyl, EPDM, Neoprene, Nitrite, Natural Rubber, Santoprene, Silicone, Viton.

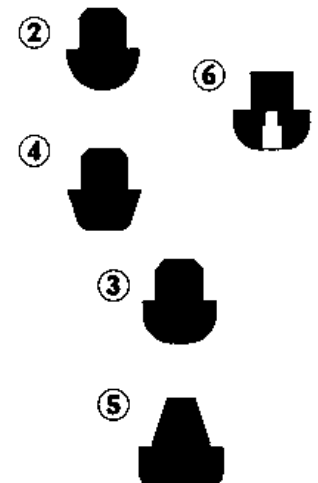
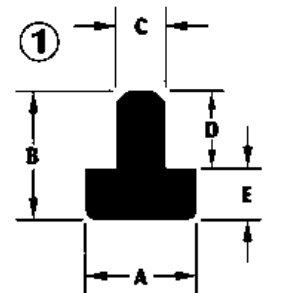

ISO 9001 Certified  
CERTIFICATE # 08-511

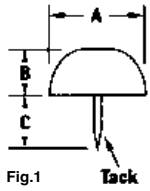

Fig.1

Standard compound is AM85 durometer SBR compound.

Volume parts can also be run in strong, durable and abrasion resistant nylon.

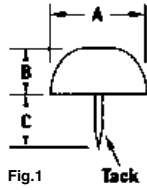

Fig.1

# TACK BUMPERS

By "B" Dimension

PART NO.	Fig No.	A			B			C		
		Inch	Dec	MM	Inch	Dec	MM	Inch	Dec	MM
TB-37	1	3/8	0.375	9.5	7/32	0.219	5.6	3/8 +	0.375 +	9.5
TB-50	1	1/2	0.500	12.7	1/4	0.250	6.4	3/8 +	0.375 +	9.5
TB-62	1	5/8	0.625	15.9	5/16	0.313	7.9	3/8 +	0.375 +	9.5
TB-75	1	3/4	0.750	19.1	3/8	0.375	9.5	3/8 +	0.375 +	9.5
TB-87	1	7/8	0.875	22.2	7/16	0.438	11.1	11/32+	0.344 +	8.7

Standard compound is AM85 durometer SBR compound.  
Volume parts can also be run in strong, durable and abrasion resistant nylon.



ISO 9001 Certified  
CERTIFICATE # 08-511

# GROMMETS

## GROMMETS BY “B” DIMENSION



2-2 - 2-18

## ARMY NAVY APPROVED AN931 GROMMETS BY “B” DIMENSION



2-19 - 2-22



# GROMMETS

By "B" Dimension

- Used to protect or cover through holes. Help eliminate sharp edges so your wires are protected and add aesthetic value to your application.
- 160 sizes available that will accommodate mounting holes ranging from .250" (6,4 mm) to holes as large as 2.50" (63,5 mm) diameter and panel thicknesses from .063" (1,6 mm) to .375" (9,5 mm).

PART NO.	Fig No.	A			B			C			D			E			F		
		Inch	Dec	MM	Inch	Dec	MM	Inch	Dec	MM	Inch	Dec	MM	Inch	Dec	MM	Inch	Dec	MM
E-2982	1	1 1/8	1.125	28.6	Note 1		0.0	1/4	0.250	6.4	1/16	0.063	1.6	15/16	0.938	23.8			
E-2995	1	1 1/8	1.125	28.6	Note 2		0.0	1/4	0.250	6.4	1/16	0.063	1.6	15/16	0.938	23.8			
E-902	5	11/32	0.344	8.7	1/16	0.063	1.6	3/16	0.188	4.8	1/16	0.063	1.6	3/16	0.188	4.8			
E-2127	1	9/32	0.281	7.1	1/16	0.063	1.6	3/16	0.188	4.8	1/16	0.063	1.6	3/16	0.188	4.8			
E-3328	1	7/32	0.219	5.6	2/25	0.080	2.0	15/79	0.190	4.8	3/50	0.060	1.5	7/50	0.140	3.6			
E-2111	1	19/64	0.300	7.6	3/32	0.090	2.3	3/16	0.192	4.9	5/64	0.070	1.8	15/64	0.240	6.1			
E-2469	5	5/16	0.313	7.9	4/43	0.093	2.4	20/93	0.215	5.5	4/87	0.046	1.2	11/47	0.234	5.9	22/83	0.265	
E-2697	5	5/16	0.312	7.9	3/32	0.093	2.4	9/64	0.145	3.7	3/64	0.041	1.0	15/64	0.234	5.9	22/83	0.265	6.7
E-2174	1	1/2	0.500	12.7	3/32	0.093	2.4	3/16	0.188	4.8	1/16	0.063	1.6	3/8	0.375	9.5	17/64	0.265	6.7
E-2253	1	5/8	0.625	15.9	3/32	0.094	2.4	1/4	0.250	6.4	3/64	0.047	1.2	7/16	0.437	11.1			
E-900	1	5/16	0.313	7.9	3/32	0.094	2.4	13/64	0.203	5.2	3/64	0.047	1.2	15/64	0.234	6.0			
E-9061	1	5/8	0.625	15.9	3/32	0.094	2.4	13/64	0.203	5.2	3/64	0.047	1.2	7/16	0.438	11.1			
E-2104	1	11/32	0.344	8.7	7/64	0.109	2.8	3/16	0.188	4.8	1/16	0.063	1.6	13/64	0.203	5.2			
E-2937	1	11/16	0.988	25.1	7/64	0.109	2.8	9/32	0.281	7.1	3/64	0.046	1.2	1/2	0.500	12.7			
E-800	1	1/4	0.250	6.4	7/64	0.109	2.8	11/64	0.172	4.4	3/64	0.047	1.2	5/32	0.156	4.0			
E-813	3	1/4	0.250	6.4	7/64	0.109	2.8	11/64	0.172	4.4	3/32	0.094	2.4	5/32	0.156	4.0			
E-1272	1	11/16	0.688	17.5	7/64	0.109	2.8	9/32	0.281	7.1	3/64	0.047	1.2	1/2	0.500	12.7			
E-2110	1	3/8	0.375	9.5	7/64	0.109	2.8	3/16	0.188	4.8	1/16	0.060	1.5	1/4	0.250	6.4			
E-2121	1	11/32	0.344	8.7	7/64	0.109	2.8	3/16	0.188	4.8	1/16	0.063	1.6	1/4	0.250	6.4			
E-2417	1	5/8	0.625	15.9	Solid	0.109	2.8	3/16	0.188	4.8	1/16	0.063	1.6	7/16	0.437	11.1			
E-2101	1	1/4	0.250	6.4	1/8	0.125	3.2	1/8	0.125	3.2	3/97	0.031	0.8	3/16	0.188	4.8			
E-9011	1	11/32	0.344	8.7	1/8	0.125	3.2	7/32	0.219	5.6	1/16	0.063	1.6	3/16	0.188	4.8			
E-901	1	11/32	0.344	8.7	1/8	0.125	3.2	7/32	0.219	5.6	1/16	0.063	1.6	1/4	0.250	6.4			
E-9013	3	3/8	0.375	9.5	1/8	0.125	3.2	1/4	0.250	6.4	1/32	0.031	0.8	1/4	0.250	6.4			
E-9014	1	11/32	0.344	8.7	1/8	0.125	3.2	3/16	0.188	4.8	1/32	0.031	0.8	1/4	0.250	6.4			
E-949	1	5/8	0.625	15.9	1/8	0.125	3.2	3/16	0.188	4.8	1/16	0.063	1.6	7/16	0.438	11.1			
E-1070-AT	1	1/4	0.250	6.4	1/8	0.125	3.2	3/32	0.094	2.4	1/32	0.031	0.8	3/16	0.188	4.8			
E-562	1	5/8	0.625	15.9	1/8	0.125	3.2	3/16	0.188	4.8	1/16	0.063	1.6	7/16	0.438	11.1			
E-2297	1	1 1/4	1.250	31.8	1/8	0.125	3.2	1/4	0.250	6.4	1/16	0.063	1.6	1	1.000	25.4			

\* Indicates I.D. is chamfered    \*\*Other D dimensions available    \*\*\*Squared corners

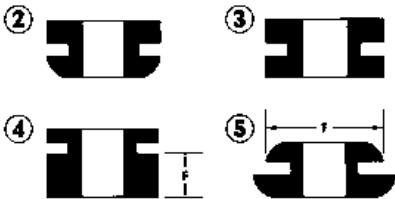
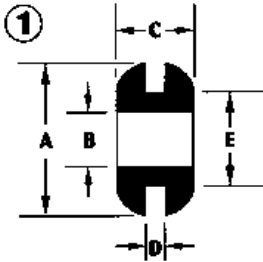

# GROMMETS

By "B" Dimension



PART NO.	Fig No.	A			B			C			D			E			F		
		Inch	Dec	MM	Inch	Dec	MM	Inch	Dec	MM	Inch	Dec	MM	Inch	Dec	MM	Inch	Dec	MM
E-2425	1	1/2	0.500	12.7	1/8	0.125	3.2	5/16	0.313	7.9	3/32	0.094	2.4	3/8	0.375	9.5			
E-2109	1	11/32	0.340	8.6	1/8	0.125	3.2	7/32	0.220	5.6	1/16	0.060	1.5	1/4	0.250	6.4			
E-2102	2	11/32	0.344	8.7	1/8	0.125	3.2	3/16	0.188	4.8	1/16	0.063	1.6	3/16	0.188	4.8			
E-2105	1	11/32	0.344	8.7	1/8	0.125	3.2	3/16	0.188	4.8	1/16	0.063	1.6	3/16	0.188	4.8			
E-2113	1	5/16	0.313	7.9	1/8	0.125	3.2	3/16	0.188	4.8	1/16	0.063	1.6	3/16	0.188	4.8			
E-2190	5	9/16	0.563	14.3	1/8	0.125	3.2	3/16	0.188	4.8	1/16	0.063	1.6	1/4	0.250	6.4	3/8	0.375	9.5
E-210	1	11/32	0.344	8.7	1/8	0.125	3.2	3/16	0.188	4.8	1/16	0.063	1.6	1/4	0.250	6.4			
E-211	2	11/32	0.344	8.7	1/8	0.125	3.2	3/16	0.188	4.8	1/16	0.063	1.6	1/4	0.250	6.4			
E-2106	1	5/16	0.313	7.9	1/8	0.125	3.2	5/32	0.156	4.0	3/64	0.040	1.0	1/4	0.250	6.4			
E-2157	1	7/16	0.438	11.1	1/8	0.125	3.2	7/32	0.219	5.6	1/16	0.063	1.6	5/16	0.313	7.9			
E-2116	1	17/32	0.531	13.5	1/8	0.125	3.2	1/4	0.250	6.4	1/16	0.063	1.6	3/8	0.375	9.5			
AN931-2-9**	1	3/4	0.750	19.1	1/8	0.125	3.2	3/16	0.188	4.8	1/16	0.063	1.6	9/16	0.563	14.3			
AN931-2-16**	1	1 1/4	1.250	31.8	1/8	0.125	3.2	1/4	0.250	6.4	1/16	0.063	1.6	1	1.000	25.4			
E-663	4	3/8	0.375	9.5	9/64	0.141	3.6	11/32	0.344	8.7	5/64	0.078	2.0	15/64	0.234	6.0	13/64	0.203	5.2
E-661	4	3/8	0.375	9.5	9/64	0.141	3.6	3/8	0.375	9.5	1/16	0.063	1.6	1/4	0.250	6.4	7/32	0.219	5.6
E-2151	1	15/32	0.469	11.9	9/64	0.141	3.6	9/32	0.281	7.1	3/32	0.094	2.4	5/16	0.313	7.9			
E-2153	1	15/32	0.469	11.9	9/64	0.141	3.6	1/4	0.250	6.4	1/16	0.063	1.6	5/16	0.313	7.9			
E-2631	5	9/16	0.563	14.3	9/64	0.141	3.6	31/64	0.484	12.3	1/8	0.125	3.2	25/64	0.391	9.9	29/64	0.453	11.5
E-2262	1	5/8	0.625	15.9	9/64	0.141	3.6	1/4	0.250	6.4	3/64	0.047	1.2	7/16	0.437	11.1			
E-2426-AC	5	1/2	0.500	12.7	10/69	0.145	3.7	11/32	0.344	8.7	1/16	0.063	1.6	1/4	0.250	6.4	3/8	0.375	9.5
E-2108	1	21/64	0.320	8.1	5/32	0.156	4.0	5/32	0.158	4.0	1/32	0.031	0.8	15/64	0.240	6.1			
E-2112	1	19/64	0.300	7.6	5/32	0.156	4.0	3/16	0.192	4.9	5/64	0.070	1.8	15/64	0.240	6.1			
E-2103	3	5/16	0.313	7.9	5/32	0.156	4.0	3/16	0.188	4.8	3/32	0.094	2.4	1/4	0.250	6.4			
E-2164	1	3/8	0.375	9.5	5/32	0.156	4.0	3/16	0.188	4.8	1/16	0.063	1.6	1/4	0.250	6.4			
E-2961	1	7/16	0.438	11.1	5/32	0.156	4.0	3/8	0.375	9.5	3/32	0.094	2.4	1/4	0.250	6.4			
E-414	1	13/32	0.406	10.3	5/32	0.156	4.0	3/8	0.375	9.5	3/32	0.094	2.4	17/64	0.266	6.7			
E-2182	1	1/2	0.500	12.7	5/32	0.156	4.0	1/4	0.250	6.4	1/32	0.031	0.8	9/32	0.281	7.1			
E-2642	1	5/8	0.625	15.9	5/32	0.156	4.0	13/64	0.203	5.2	3/64	0.047	1.2	7/16	0.437	11.1			
E-2516	5	1/2	0.500	12.7	5/32	0.156	4.0	29/64	0.453	11.5	3/16	0.188	4.8	15/67	0.224	5.7	9/32	0.281	7.1
E-919	5	3/8	0.375	9.5	5/32	0.156	4.0	5/16	0.313	7.9	1/16	0.063	1.6	15/64	0.234	6.0	9/32	0.281	7.1
E-9015	3	21/64	0.328	8.3	5/32	0.156	4.0	13/64	0.203	5.2	7/64	0.109	2.8	1/4	0.250	6.4			
E-808	1	1/2	0.500	12.7	5/32	0.156	4.0	7/32	0.219	5.6	1/16	0.063	1.6	3/8	0.375	9.5			
E-9118	1	11/16	0.688	17.5	5/32	0.156	4.0	9/32	0.281	7.1	1/16	0.063	1.6	1/2	0.500	12.7			
E-1259	1	3/8	0.375	9.5	5/32	0.156	4.0	3/16	0.188	4.8	1/16	0.063	1.6	1/4	0.250	6.4			
E-374	1	7/16	0.438	11.1	5/32	0.156	4.0	3/8	0.375	9.5	3/32	0.094	2.4	1/4	0.250	6.4			
E-2107	3	5/16	0.313	7.9	5/32	0.156	4.0	1/8	0.128	3.3	1/16	0.063	1.6	1/4	0.250	6.4			
E-2356	3	5/8	0.625	15.9	11/64	0.172	4.4	9/32	0.281	7.1	1/32	0.031	0.8	15/32	0.469	11.9			
E-233	3	5/8	0.625	15.9	17/64	0.172	4.4	3/8	0.375	9.5	1/8	0.125	3.2	15/32	0.469	11.9			
E-1100	5	3/4	0.750	19.1	17/64	0.172	4.4	1/4	0.250	6.4	1/32	0.035	0.9	15/32	0.469	11.9	5/8	0.625	15.9

\* Indicates I.D. is chamfered    \*\*Other D dimensions available    \*\*\*Squared corners

- Used to protect or cover through holes. Help eliminate sharp edges so your wires are protected and add aesthetic value to your application.
- 160 sizes available that will accommodate mounting holes ranging from .250" (6,4 mm) to holes as large as 2.50" (63,5 mm) diameter and panel thicknesses from .063" (1,6 mm) to .375" (9,5 mm).
- Rubber grommets are constructed of SBR with an operating temperature range of -40°F (-40°C) to 221°F (105°C).

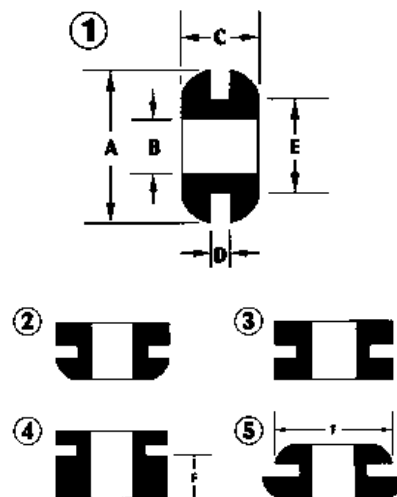



# GROMMETS

By "B" Dimension

- Used to protect or cover through holes. Help eliminate sharp edges so your wires are protected and add aesthetic value to your application.
- 160 sizes available that will accommodate mounting holes ranging from .250" (6,4 mm) to holes as large as 2.50" (63,5 mm) diameter and panel thicknesses from .063" (1,6 mm) to .375" (9,5 mm).

PART NO.	Fig No.	A			B			C			D			E			F		
		Inch	Dec	MM	Inch	Dec	MM	Inch	Dec	MM	Inch	Dec	MM	Inch	Dec	MM	Inch	Dec	MM
E-2165	1	7/16	0.440	11.2	11/64	0.172	4.4	3/16	0.184	4.7	3/64	0.055	1.4	1/4	0.250	6.4			
E-90251	3	7/16	0.438	11.1	11/64	0.172	4.4	19/64	0.250	6.4	11/64	0.172	4.4	5/16	0.313	7.9			
E-3312	3	16/41	0.390	9.9	15/82	0.183	4.6	7/24	0.292	7.4	8/87	0.092	2.3	2/9	0.223	5.7			
E-2507	5	5/16	0.313	7.9	3/16	0.188	4.8	7/40	0.175	4.4	4/87	0.046	1.2	11/47	0.234	5.9	22/83	0.265	6.7
E-2406-AC	5	5/8	0.625	15.9	3/16	0.188	4.8	9/16	0.563	14.3	5/16	0.313	7.9	3/8	0.375	9.5	1/2	0.500	12.7
E-2443	5-1	7/16	0.438	11.1	3/16	0.188	4.8	3/8	0.375	9.5	3/16	0.188	4.8	1/4	0.250	6.4	5/16	0.313	7.9
E-90121	1	11/32	0.344	8.7	3/16	0.188	4.8	3/16	0.188	4.8	1/16	0.063	1.6	9/64	0.141	3.6			
E-9024	1	13/32	0.406	10.3	3/16	0.188	4.8	5/16	0.313	7.9	3/32	0.094	2.4	9/32	0.281	7.1			
E-903	1	13/32	0.406	10.3	3/16	0.188	4.8	7/32	0.219	5.6	1/16	0.063	1.6	5/16	0.313	7.9			
E-9032	1	13/32	0.406	10.3	3/16	0.188	4.8	3/16	0.188	4.8	1/32	0.031	0.8	5/16	0.313	7.9			
E-943	5	5/8	0.625	15.9	3/16	0.188	4.8	7/32	0.219	5.6	1/32	0.031	0.8	5/16	0.313	7.9	7/16	0.438	11.1
E-944	5	5/8	0.625	15.9	3/16	0.188	4.8	7/32	0.219	5.6	1/16	0.063	1.6	5/16	0.313	7.9	7/16	0.438	11.1
E-8051	1	1/2	0.500	12.7	3/16	0.188	4.8	1/4	0.250	6.4	1/16	0.063	1.6	5/16	0.313	7.9			
E-805	1	1/2	0.500	12.7	3/16	0.188	4.8	9/32	0.281	7.1	3/32	0.094	2.4	5/16	0.313	7.9			
E-8052	1	1/2	0.500	12.7	3/16	0.188	4.8	1/4	0.250	6.4	1/16	0.063	1.6	23/64	0.359	9.1			
E-912	1	5/8	0.625	15.9	3/16	0.188	4.8	3/8	0.375	9.5	3/16	0.188	4.8	3/8	0.375	9.5			
E-857	1	9/16	0.563	14.3	3/16	0.188	4.8	3/8	0.375	9.5	1/8	0.125	3.2	7/16	0.438	11.1			
E-1390	1	7/16	0.438	11.1	3/16	0.188	4.8	7/32	0.219	5.6	1/32	0.031	0.8	5/16	0.313	7.9			
E-2045	1	7/8	0.875	22.2	3/16	0.188	4.8	7/32	0.219	5.6	1/32	0.031	0.8	11/16	0.688	17.5			
E-382	1	7/16	0.438	11.1	3/16	0.188	4.8	7/32	0.219	5.6	1/16	0.063	1.6	9/32	0.281	7.1			
E-2286	1	7/16	0.438	11.1	3/16	0.188	4.8	3/16	0.188	4.8	1/16	0.063	1.6	5/16	0.313	7.9			
E-1453	1	1/2	0.500	12.7	3/16	0.188	4.8	1/4	0.250	6.4	1/16	0.063	1.6	5/16	0.313	7.9			
E-2279	1	3/4	0.750	19.1	3/16	0.188	4.8	3/16	0.188	4.8	1/16	0.063	1.6	9/16	0.563	14.3			
E-1734	1	7/16	0.438	11.1	3/16	0.188	4.8	7/32	0.219	5.6	3/32	0.094	2.4	9/32	0.281	7.1			
E-2537	1	5/8	0.625	15.9	3/16	0.188	4.8	3/8	0.375	9.5	3/32	0.094	2.4	11/32	0.344	8.7			
E-2852	1	7/16	0.438	11.1	3/16	0.188	4.8	1/4	0.250	6.4	1/8	0.125	3.2	5/16	0.313	7.9			
E-2752	1	7/16	0.438	11.1	3/16	0.188	4.8	5/16	0.313	7.9	3/16	0.188	4.8	5/16	0.313	7.9			
E-704	1	5/8	0.625	15.9	3/16	0.188	4.8	3/8	0.375	9.5	3/16	0.188	4.8	3/8	0.375	9.5			
E-2552	1	7/16	0.438	11.1	3/16	0.188	4.8	3/8	0.375	9.5	1/4	0.250	6.4	5/16	0.313	7.9			

\* Indicates I.D. is chamfered    \*\*Other D dimensions available    \*\*\*Squared corners

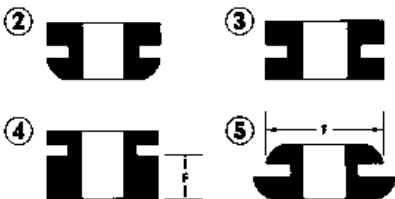
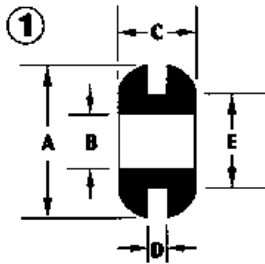

# GROMMETS

By "B" Dimension



PART NO.	Fig No.	A			B			C			D			E			F		
		Inch	Dec	MM	Inch	Dec	MM	Inch	Dec	MM	Inch	Dec	MM	Inch	Dec	MM	Inch	Dec	MM
E-3322	5	7/16	0.435	11.0	3/16	0.188	4.8	1/4	0.250	6.4	3/32	0.094	2.4	1/4	0.250	6.4	3/8	0.372	-9.4
E-2533*	3	25/64	0.386	9.8	3/16	0.188	4.8	13/64	0.200	5.1	3/64	0.054	1.4	1/4	0.250	6.4			
E-2629	1	13/32	0.406	10.3	3/16	0.188	4.8	17/64	0.270	6.9	7/64	0.102	2.6	19/64	0.296	7.5			
E-2919	1	13/32	0.412	10.5	3/16	0.188	4.8	9/32	0.275	7.0	1/16	0.060	1.5	5/16	0.312	7.9			
E-215	1	7/16	0.438	11.1	3/16	0.188	4.8	7/32	0.219	5.6	1/16	0.063	1.6	5/16	0.313	7.9			
E-216	2	7/16	0.438	11.1	3/16	0.188	4.8	7/32	0.219	5.6	1/16	0.063	1.6	5/16	0.313	7.9			
E-415	1	7/16	0.438	11.1	3/16	0.188	4.8	1/4	0.250	6.4	3/32	0.094	2.4	5/16	0.313	7.9			
E-416	2	7/16	0.438	11.1	3/16	0.188	4.8	1/4	0.250	6.4	3/32	0.094	2.4	5/16	0.313	7.9			
AN931-3-5**	1	7/16	0.438	11.1	3/16	0.188	4.8	3/16	0.187	4.7	1/16	0.063	1.6	5/16	0.313	7.9			
E-2152	1	7/16	0.438	11.1	3/16	0.188	4.8	7/32	0.219	5.6	3/64	0.040	1.0	5/16	0.313	7.9			
E-2156	1	7/16	0.438	11.1	3/16	0.188	4.8	3/16	0.187	4.7	1/32	0.031	0.8	5/16	0.313	7.9			
E-2158	1	13/32	0.406	10.3	3/16	0.188	4.8	13/64	0.203	5.2	1/16	0.063	1.6	5/16	0.313	7.9			
E-2159	3	7/16	0.438	11.1	3/16	0.188	4.8	9/32	0.281	7.1	3/32	0.094	2.4	5/16	0.313	7.9			
E-2173	1	1/2	0.500	12.7	3/16	0.188	4.8	7/32	0.219	5.6	1/16	0.063	1.6	5/16	0.313	7.9			
E-2180	3	1/2	0.500	12.7	3/16	0.188	4.8	15/64	0.234	6.0	7/64	0.109	2.8	5/16	0.313	7.9			
E-2181	3	1/2	0.500	12.7	3/16	0.188	4.8	7/32	0.219	5.6	1/8	0.125	3.2	5/16	0.313	7.9			
E-2293	5	5/8	0.625	15.9	3/16	0.188	4.8	1/4	0.250	6.4	1/16	0.063	1.6	5/16	0.313	7.9	7/16	0.438	11.1
E-3317	1	5/8	0.625	15.9	3/16	0.188	4.8	3/8	0.375	9.5	3/32	0.094	2.4	11/32	0.344	8.7			
E-2171	1	1/2	0.500	12.7	3/16	0.188	4.8	3/16	0.188	4.8	1/32	0.031	0.8	3/8	0.375	9.5			
E-217	1	33/64	0.525	13.3	3/16	0.188	4.8	7/32	0.219	5.6	1/16	0.063	1.6	3/8	0.375	9.5			
E-2175	3	3/8	0.375	9.5	3/16	0.188	4.8	11/64	0.172	4.4	3/64	0.047	1.2	1/4	0.250	6.4			
E-2178	1	3/8	0.375	9.5	3/16	0.188	4.8	3/16	0.188	4.8	1/32	0.031	0.8	1/4	0.250	6.4			
E-2179	3	3/8	0.375	9.5	3/16	0.188	4.8	3/16	0.188	4.8	1/16	0.063	1.6	1/4	0.250	6.4			
E-2968	3	25/64	0.386	9.8	3/16	0.188	4.8	3/16	0.199	5.1	3/64	0.052	1.3	1/4	0.250	6.4			
E-3363	5	7/16	0.446	11.3	3/16	0.188	4.8	1/4	0.255	6.5	3/32	0.095	2.4	1/4	0.255	6.5	25/64	0.383	9.7
E-3368	5	33/64	0.510	13.0	3/16	0.188	4.8	25/64	0.390	9.9	13/64	0.196	5.0	17/64	0.260	6.6	21/64	0.326	8.3
E-2669	1	7/16	0.438	11.1	3/16	0.188	4.8	7/32	0.219	5.6	1/16	0.063	1.6	9/32	0.281	7.1			
E-3381	1	7/16	0.446	11.3	3/16	0.188	4.8	7/32	0.228	5.8	3/32	0.100	2.5	19/64	0.290	7.4			
E-2162	3	7/16	0.438	11.1	3/16	0.188	4.8	9/32	0.281	7.1	3/32	0.094	2.4	19/64	0.297	7.5			
E-3377	1	7/16	0.446	11.3	3/16	0.188	4.8	7/32	0.224	5.7	1/32	0.032	0.8	5/16	0.319	8.1			
E-2351	1	5/8	0.625	15.9	3/16	0.188	4.8	11/32	0.344	8.7	1/16	0.063	1.6	3/8	0.375	9.5			
E-2662***	5	3/4	0.750	19.1	3/16	0.188	4.8	5/8	0.625	15.9	11/64	0.172	4.4	3/8	0.375	9.5	33/64	0.516	13.1
E-2981	1	5/8	0.625	15.9	3/16	0.188	4.8	3/8	0.375	9.5	3/16	0.188	4.8	3/8	0.375	9.5			
E-2201	1	9/16	0.563	14.3	3/16	0.188	4.8	3/8	0.375	9.5	1/8	0.125	3.2	7/16	0.437	11.1			
E-2034-AC	4	9/16	0.563	14.3	3/16	0.188	4.8	27/64	0.422	10.7	3/64	0.047	1.2	7/16	0.437	11.1	9/32	0.281	7.1
E-2038	3	11/16	0.688	17.5	3/16	0.188	4.8	3/8	0.375	9.5	1/8	0.125	3.2	1/2	0.500	12.7			
E-2672	5	11/16	0.688	17.5	3/16	0.188	4.8	23/32	0.719	18.3	1/16	0.063	1.6	1/2	0.500	12.7	7/16	0.438	11.1

\* Indicates I.D. is chamfered    \*\*Other D dimensions available    \*\*\*Squared corners

- Used to protect or cover through holes. Help eliminate sharp edges so your wires are protected and add aesthetic value to your application.
- 160 sizes available that will accommodate mounting holes ranging from .250" (6,4 mm) to holes as large as 2.50" (63,5 mm) diameter and panel thicknesses from .063" (1,6 mm) to .375" (9,5 mm).

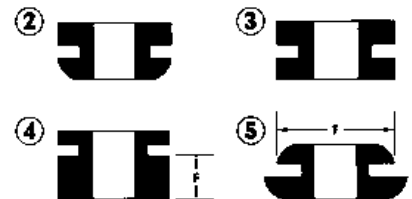
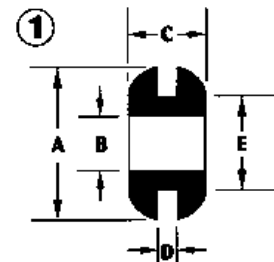

ISO 9001 Certified  
CERTIFICATE # 08-511



# GROMMETS

By "B" Dimension

- Used to protect or cover through holes. Help eliminate sharp edges so your wires are protected and add aesthetic value to your application.
- 160 sizes available that will accommodate mounting holes ranging from .250" (6,4 mm) to holes as large as 2.50" (63,5 mm) diameter and panel thicknesses from .063" (1,6 mm) to .375" (9,5 mm).

PART NO.	Fig No.	A			B			C			D			E			F		
		Inch	Dec	MM	Inch	Dec	MM	Inch	Dec	MM	Inch	Dec	MM	Inch	Dec	MM	Inch	Dec	MM
AN931-3-9	1	3/4	0.750	19.1	3/16	0.188	4.8	3/16	0.188	4.8	1/16	0.063	1.6	9/16	0.563	14.3			
AN931-3-10	1	7/8	0.875	22.2	3/16	0.188	4.8	3/16	0.188	4.8	1/16	0.063	1.6	5/8	0.625	15.9			
E-2119	1	27/32	0.844	21.4	3/16	0.188	4.8	5/16	0.313	7.9	1/16	0.063	1.6	21/32	0.656	16.7			
E-2122	S	1 1/4	1.250	31.8	3/16	0.188	4.8	5/16	0.313	7.9	1/16	0.063	1.6	1	1.000	25.4			
E-2548	1	2/5	0.400	10.2	1/5	0.201	5.1	17/50	0.340	8.6	5/41	0.122	3.1	11/40	0.275	7.0			2.5
E-2161	1	7/16	0.438	11.1	13/64	0.203	5.2	5/32	0.156	4.0	1/32	0.031	0.8	21/64	0.328	8.3			
E-2185	4	1/2	0.500	12.7	13/64	0.203	5.2	21/64	0.328	8.3	3/64	0.047	1.2	5/16	0.313	7.9	5/32	0.160	4.1
E-2115	3	47/64	0.734	18.7	13/64	0.203	5.2	31/64	0.484	12.3	7/64	0.109	2.8	33/64	0.516	13.1			
E-9033	1	7/16	0.438	11.1	13/64	0.203	5.2	15/64	0.234	6.0	3/64	0.047	1.2	5/16	0.313	7.9			
E-565	1	9/16	0.563	14.3	13/64	0.203	5.2	3/8	0.375	9.5	1/8	0.125	3.2	13/32	0.406	10.3			
E-2538*	3	7/16	0.438	11.1	13/64	0.204	5.2	1/4	0.250	6.4	1/16	0.063	1.6	11/32	0.350	8.9			
E-2163	1	25/64	0.400	10.2	13/64	0.200	5.2	3/16	0.180	4.6	1/16	0.060	1.5	19/64	0.300	7.6			
E-2155	1	7/16	0.438	11.1	13/64	0.200	5.2	1/4	0.250	6.4	3/64	0.050	1.3	5/16	0.313	7.9			
E-3367	3	7/16	0.446	11.3	13/64	0.207	5.2	1/4	0.256	6.5	3/64	0.050	1.3	21/64	0.323	8.2			
E-2118	1	7/16	0.438	11.1	7/32	0.219	5.6	9/32	0.281	7.1	1/8	0.125	3.2	5/16	0.313	7.9			
E-2154	1	15/32	0.469	11.9	7/32	0.219	5.6	1/8	0.125	3.2	1/32	0.031	0.8	5/16	0.313	7.9			
E-2160	1	7/16	0.438	11.1	7/32	0.219	5.6	3/16	0.187	4.7	1/16	0.063	1.6	5/16	0.313	7.9			
E-2189	4	1/2	0.500	12.7	7/32	0.219	5.6	5/16	0.313	7.9	3/64	0.047	1.2	5/16	0.313	7.9	11/64	0.172	4.4
E-3369	1	7/16	0.446	11.3	7/32	0.219	5.6	7/32	0.222	5.6	1/32	0.032	0.8	21/64	0.321	8.2			
E-2177	3	17/32	0.531	13.5	7/32	0.219	5.6	3/8	0.375	9.5	1/8	0.125	3.2	11/32	0.344	8.7			
E-2191	1	17/32	0.531	13.5	7/32	0.219	5.6	25/64	0.391	9.9	5/64	0.078	2.0	11/32	0.344	8.7			
E-219	1	33/64	0.515	13.1	7/32	0.219	5.6	13/32	0.406	10.3	3/32	0.094	2.4	11/32	0.344	8.7			
E-2186	3	1/2	0.500	12.7	7/32	0.219	5.6	1/4	0.250	6.4	3/64	0.047	1.2	3/8	0.380	9.7			
E-2254	1	5/8	0.625	15.9	7/32	0.219	5.6	11/64	0.172	4.4	3/64	0.047	1.2	7/16	0.437	11.1			
E-2678	4	3/4	0.750	19.1	7/32	0.219	5.6	5/8	0.625	15.9	1/16	0.063	1.6	1/2	0.500	12.7	1/2	0.500	12.7
E-2429	5	1/2	0.500	12.7	7/32	0.219	5.6	7/16	0.438	11.1	1/16	0.063	1.6	5/16	0.313	7.9	7/16	0.438	11.1
E-1105-LA	4	1/2	0.500	12.7	7/32	0.219	5.6	5/16	0.313	7.9	1/16	0.063	1.6	11/32	0.344	8.7	5/32	0.156	4.0
E-1411	1	7/16	0.438	11.1	7/32	0.219	5.6	3/16	0.188	4.8	1/16	0.063	1.6	5/16	0.313	7.9			
E-2526	5	33/50	0.660	16.8	11/50	0.220	5.6	6/25	0.240	6.1	4/57	0.070	1.8	22/71	0.310	7.9	16/39	0.410	10.4

\* Indicates I.D. is chamfered    \*\*Other D dimensions available    \*\*\*Squared corners

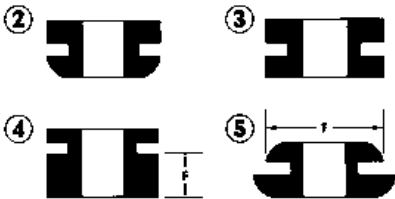
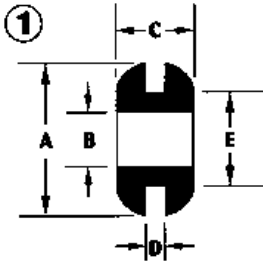



# GROMMETS

## By "B" Dimension



PART NO.	Fig No.	A			B			C			D			E			F		
		Inch	Dec	MM	Inch	Dec	MM	Inch	Dec	MM	Inch	Dec	MM	Inch	Dec	MM	Inch	Dec	MM
E-2638	4	1/2	0.500	12.7	7/32	0.220	5.6	11/32	0.343	8.7	1/32	0.032	0.8	5/16	0.312	7.9			
E-2126	4	7/16	0.443	11.3	7/32	0.219	5.6	19/64	0.295	7.5	1/16	0.063	1.6	5/16	0.313	7.9	11/64	0.173	4.4
E-2204	3	9/16	0.563	14.3	7/32	0.219	5.6	5/16	0.313	7.9	1/16	0.063	1.6	7/16	0.442	11.2			
E-2192	3	17/32	0.531	13.5	7/32	0.219	5.6	3/8	0.375	9.5	1/16	0.063	1.6	11/32	0.344	8.7			
E-2641	4	9/16	0.563	14.3	7/32	0.219	5.6	3/8	0.375	9.5	3/64	0.047	1.2	3/8	0.375	9.5	1/4	0.250	6.4
E-2537*	3	7/16	0.438	11.1	3/16	0.188	4.8	1/4	0.250	6.4	1/16	0.063	1.6	11/32	0.350	8.9			
E-1840	1	5/8	0.625	15.9	15/64	0.234	6.0	3/8	0.375	9.5	3/16	0.188	4.8	3/8	0.375	9.5			
E-3371	1	41/64	0.635	16.1	15/64	0.234	6.0	3/8	0.380	9.7	3/16	0.190	4.8	3/8	0.382	9.7			
E-3308	1	5/8	0.625	15.9	12/49	0.245	6.2	3/8	0.375	9.5	3/16	0.188	4.8	3/8	0.375	9.5			
E-2592	5	11/16	0.687	17.4	1/4	0.250	6.4	22/83	0.265	6.7	1/20	0.050	1.3	5/16	0.312	7.9	3/8	0.375	9.5
E-3316	1	1/2	0.500	12.7	1/4	0.250	6.4	1/4	0.250	6.4	3/32	0.094	2.4	3/8	0.375	9.5			
E-904	1	1/2	0.500	12.7	1/4	0.250	6.4	5/32	0.156	4.0	1/32	0.031	0.8	11/32	0.344	8.7			
E-971	1	1/2	0.500	12.7	1/4	0.250	6.4	3/16	0.188	4.8	1/16	0.063	1.6	11/32	0.344	8.7			
E-807-LA	1	1/2	0.500	12.7	1/4	0.250	6.4	3/16	0.188	4.8	1/16	0.063	1.6	3/8	0.375	9.5			
E-809	5	9/16	0.563	14.3	1/4	0.250	6.4	3/16	0.188	4.8	5/64	0.078	2.0	3/8	0.375	9.5	15/32	0.469	11.9
E-9053	1	5/8	0.625	15.9	1/4	0.250	6.4	11/32	0.344	8.7	1/16	0.063	1.6	3/8	0.375	9.5			
E-916	4	9/16	0.563	14.3	1/4	0.250	6.4	7/16	0.438	11.1	3/64	0.047	1.2	3/8	0.375	9.5	17/64	0.266	6.8
E-8701	3	9/16	0.563	14.3	1/4	0.250	6.4	19/64	0.297	7.5	3/64	0.047	1.2	3/8	0.375	9.5			
E-1122	4	21/32	0.656	16.7	1/4	0.250	6.4	3/8	0.375	9.5	1/16	0.063	1.6	13/32	0.406	10.3	7/32	0.219	5.6
E-845	5	7/8	0.875	22.2	1/4	0.250	6.4	3/8	0.375	9.5	3/32	0.094	2.4	13/32	0.406	10.3	3/4	0.750	19.1
E-847	5	1	1.000	25.4	1/4	0.250	6.4	1/4	0.250	6.4	3/64	0.047	1.2	7/16	0.438	11.1	3/4	0.750	19.1
E-8702	3	9/16	0.563	14.3	1/4	0.250	6.4	5/16	0.313	7.9	1/16	0.063	1.6	7/16	0.438	11.1			
E-1111	3	5/8	0.625	15.9	1/4	0.250	6.4	7/16	0.438	11.1	1/16	0.063	1.6	7/16	0.438	11.1			
E-1137	4	3/4	0.750	19.1	1/4	0.250	6.4	9/16	0.563	14.3	1/16	0.063	1.6	7/16	0.438	11.1	3/8	0.375	9.5
E-923	3	3/4	0.750	19.1	1/4	0.250	6.4	7/16	0.438	11.1	1/8	0.125	3.2	1/2	0.500	12.7			
E-2902	1	1/2	0.500	12.7	1/4	0.250	6.4	1/4	0.250	6.4	1/16	0.063	1.6	3/8	0.375	9.5			
E-97	1	5/8	0.625	15.9	1/4	0.250	6.4	3/16	0.188	4.8	1/16	0.063	1.6	7/16	0.438	11.1			
E-2298	1	1 1/4	1.250	31.8	1/4	0.250	6.4	1/4	0.250	6.4	1/16	0.063	1.6	1	1.000	25.4			
E-2901	1	1/2	0.500	12.7	1/4	0.250	6.4	1/4	0.250	6.4	3/32	0.094	2.4	3/8	0.375	9.5			
E-2903-AT	1	1/2	0.500	12.7	1/4	0.250	6.4	1/4	0.250	6.4	1/8	0.125	3.2	3/8	0.375	9.5			
E-2554	1	5/8	0.625	15.9	1/4	0.250	6.4	3/8	0.375	9.5	1/4	0.250	6.4	7/16	0.438	11.1			
E-696	1	5/8	0.625	15.9	1/4	0.250	6.4	1/2	0.500	12.7	1/4	0.250	6.4	15/32	0.469	11.9			
E-2555	1	1 1/4	1.250	31.8	1/4	0.250	6.4	7/16	0.438	11.1	1/4	0.250	6.4	1	1.000	25.4			
E-2684	5	9/16	0.563	14.3	1/4	0.250	6.4	1/4	0.250	6.4	1/16	0.063	1.6	5/16	0.313	7.9	3/8	0.375	9.5
E-2172	1	1/2	0.500	12.7	1/4	0.250	6.4	5/32	0.156	4.0	1/32	0.031	0.8	5/16	0.313	7.9			
E-2183	3	1/2	0.500	12.7	1/4	0.250	6.4	1/4	0.250	6.4	1/16	0.063	1.6	5/16	0.313	7.9			
E-2176	1	1/2	0.500	12.7	1/4	0.250	6.4	3/16	0.188	4.8	1/16	0.063	1.6	11/32	0.344	8.7			
E-203	4	9/16	0.563	14.3	1/4	0.250	6.4	9/32	0.281	7.1	1/16	0.063	1.6	3/8	0.375	9.5	5/32	0.156	4.0
E-220	1	9/16	0.563	14.3	1/4	0.250	6.4	1/4	0.250	6.4	1/16	0.063	1.6	3/8	0.375	9.5			

- Used to protect or cover through holes. Help eliminate sharp edges so your wires are protected and add aesthetic value to your application.
- 160 sizes available that will accommodate mounting holes ranging from .250" (6,4 mm) to holes as large as 2.50" (63,5 mm) diameter and panel thicknesses from .063" (1,6 mm) to .375" (9,5 mm).

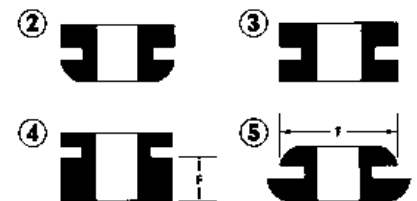
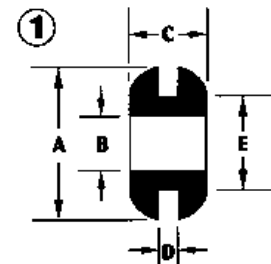

\* Indicates I.D. is chamfered    \*\*Other D dimensions available    \*\*\*Squared corners





# GROMMETS

By "B" Dimension

- Used to protect or cover through holes. Help eliminate sharp edges so your wires are protected and add aesthetic value to your application.
- 160 sizes available that will accommodate mounting holes ranging from .250" (6,4 mm) to holes as large as 2.50" (63,5 mm) diameter and panel thicknesses from .063" (1,6 mm) to .375" (9,5 mm).

PART NO.	Fig No.	A			B			C			D			E			F		
		Inch	Dec	MM	Inch	Dec	MM	Inch	Dec	MM	Inch	Dec	MM	Inch	Dec	MM	Inch	Dec	MM
E-222	2	9/16	0.563	14.3	1/4	0.250	6.4	1/4	0.250	6.4	1/16	0.063	1.6	3/8	0.375	9.5			
E-320	2	9/16	0.563	14.3	1/4	0.250	6.4	5/16	0.313	7.9	1/8	0.125	3.2	3/8	0.375	9.5			
E-2036	4	1/2	0.500	12.7	1/4	0.250	6.4	21/32	0.656	16.7	3/64	0.050	1.3	3/8	0.375	9.5	1/2	0.500	12.7
E-2188	1	1/2	0.500	12.7	1/4	0.250	6.4	11/64	0.172	4.4	3/64	0.047	1.2	3/8	0.375	9.5			
E-2202	2	9/16	0.563	14.3	1/4	0.250	6.4	3/8	0.375	9.5	5/32	0.156	4.0	3/8	0.375	9.5			
E-2251	1	5/8	0.625	15.9	1/4	0.250	6.4	11/32	0.344	8.7	1/16	0.063	1.6	3/8	0.375	9.5			
E-2260	1	5/8	0.625	15.9	1/4	0.250	6.4	9/32	0.281	7.1	1/16	0.063	1.6	3/8	0.375	9.5			
E-3251	1	5/8	0.625	15.9	1/4	0.250	6.4	3/8	0.375	9.5	1/8	0.125	3.2	3/8	0.375	9.5			
E-3345	1	1/2	0.500	12.7	1/4	0.250	6.4	3/16	0.188	4.8	1/16	0.060	1.5	3/8	0.374	9.5			
E-2622	1	1/2	0.500	12.7	1/4	0.250	6.4	7/32	0.219	5.6	1/16	0.063	1.6	3/8	0.375	9.5			
E-2991	1	1/2	0.500	12.7	1/4	0.250	6.4	1/4	0.250	6.4	1/8	0.125	3.2	3/8	0.375	9.5			
E-523	1	19/32	0.594	15.1	1/4	0.250	6.4	11/64	0.172	4.4	3/64	0.047	1.2	13/32	0.406	10.3			
E-2039	4	21/32	0.656	16.7	1/4	0.250	6.4	3/8	0.375	9.5	1/16	0.063	1.6	13/32	0.406	10.3	7/32	0.218	5.5
AN931-4-7	1	5/8	0.625	15.9	1/4	0.250	6.4	3/16	0.188	4.8	1/16	0.063	1.6	7/16	0.437	11.1			
E-2664	3	5/8	0.625	15.9	1/4	0.250	6.4	3/8	0.375	9.5	1/8	0.125	3.2	7/16	0.437	11.1			
E-2292	5	5/8	0.625	15.9	1/4	0.250	6.4	29/64	0.453	11.5	1/8	0.125	3.2	7/16	0.437	11.1	9/16	0.562	14.3
E-2040	5	7/8	0.875	22.2	1/4	0.250	6.4	3/8	0.375	9.5	4/57	0.070	1.8	1/2	0.500	12.7	3/4	0.750	19.1
E-2257	1	5/8	0.625	15.9	1/4	0.250	6.4	17/32	0.531	13.5	9/32	0.281	7.1	1/2	0.500	12.7			
E-2261	1	3/4	0.750	19.1	1/4	0.250	6.4	11/64	0.172	4.4	1/16	0.063	1.6	9/16	0.563	14.3			
E-2903-AC	1	13/16	0.812	20.6	1/4	0.250	6.4	1/2	0.500	12.7	1/4	0.255	6.5	9/16	0.562	14.3			
AN931-4-12	1	1.000	25.4	1/4	0.250	6.4	1/4	0.250	6.4	1/16	0.063	1.6	3/4	0.750	19.1				
AN931-4-16	1	1 1/4	1.250	31.8	1/4	0.250	6.4	1/4	0.250	6.4	1/16	0.063	1.6	1	1.000	25.4			
E-1116	3	1 1/2	1.500	38.1	1/4	0.250	6.4	7/16	0.438	11.1	1/16	0.063	1.6	1 3/16	1.188	30.2			
E-1106	3	1 1/2	1.500	38.1	1/4	0.250	6.4	7/16	0.438	11.1	1/16	0.063	1.6	1 1/4	1.250	31.8			
E-2627	1	5/8	0.625	15.9	1/4	0.250	6.4	9/32	0.280	7.1	3/32	0.093	2.4	27/64	0.425	10.8			
E-2411	1	9/16	0.563	14.3	17/64	0.266	6.7	19/64	0.297	7.5	3/64	0.047	1.2	3/8	0.375	9.5	9/64	0.141	3.6
E-2255	1	5/8	0.625	15.9	17/64	0.266	6.7	5/16	0.313	7.9	1/16	0.063	1.6	7/16	0.437	11.1			
E-2290	5	11/16	0.688	17.5	17/64	0.266	6.7	1/4	0.250	6.4	1/16	0.063	1.6	7/16	0.437	11.1	9/16	0.562	14.3
E-990	1	5/8	0.625	15.9	17/64	0.266	6.7	3/8	0.375	9.5	1/8	0.125	3.2	13/32	0.406	10.3			

\* Indicates I.D. is chamfered    \*\*Other D dimensions available    \*\*\*Squared corners

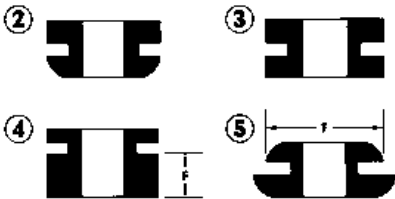
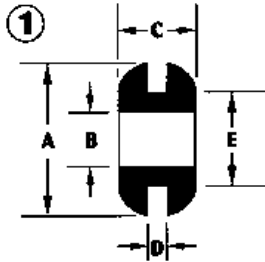

# GROMMETS

By "B" Dimension



PART NO.	Fig No.	A			B			C			D			E			F		
		Inch	Dec	MM	Inch	Dec	MM	Inch	Dec	MM	Inch	Dec	MM	Inch	Dec	MM	Inch	Dec	MM
E-3372-2	4	9/16	0.571	14.5	9/32	0.281	7.1	3/8	0.386	9.8	5/64	0.080	2.0	27/64	0.416	10.6	13/64	0.194	4.9
E-2212	1	9/16	0.563	14.3	9/32	0.281	7.1	1/4	0.250	6.4	1/32	0.031	0.8	3/8	0.375	9.5			
E-221	1	9/16	0.563	14.3	9/32	0.281	7.1	1/4	0.250	6.4	1/16	0.063	1.6	3/8	0.375	9.5			
E-321	1	9/16	0.563	14.3	9/32	0.281	7.1	5/16	0.313	7.9	1/8	0.125	3.2	3/8	0.375	9.5			
E-2187	3	1/2	0.500	12.7	9/32	0.281	7.1	1/4	0.250	6.4	3/64	0.047	1.2	3/8	0.380	9.7			
E-9051	1	19/32	0.594	15.1	9/32	0.281	7.1	13/64	0.203	5.2	1/16	0.063	1.6	3/8	0.375	9.5			
E-9052	1	9/16	0.563	14.3	9/32	0.281	7.1	7/32	0.219	5.6	1/16	0.063	1.6	3/8	0.375	9.5			
E-905	1	9/16	0.563	14.3	9/32	0.281	7.1	1/4	0.250	6.4	1/16	0.063	1.6	3/8	0.375	9.5			
E-921	1	5/8	0.625	15.9	9/32	0.281	7.1	11/32	0.344	8.7	5/32	0.156	4.0	3/8	0.375	9.5			
E-9811	1	19/32	0.594	15.1	9/32	0.281	7.1	11/64	0.172	4.4	3/64	0.047	1.2	13/32	0.406	10.3			
E-907	1	5/8	0.625	15.9	9/32	0.281	7.1	1/4	0.250	6.4	1/16	0.063	1.6	7/16	0.438	11.1			
E-908	1	37/64	0.578	14.7	9/32	0.281	7.1	5/16	0.313	7.9	1/16	0.063	1.6	15/32	0.469	11.9			
E-9112	1	21/32	0.656	16.7	9/32	0.281	7.1	3/8	0.375	9.5	3/64	0.047	1.2	1/2	0.500	12.7			
E-1019	1	1 1/8	1.125	28.6	9/32	0.281	7.1	3/8	0.375	9.5	1/8	0.125	3.2	7/8	0.875	22.2			
E-1028	1	1 1/8	1.125	28.6	9/32	0.281	7.1	11/32	0.344	8.7	3/32	0.094	2.4	7/8	0.875	22.2			
E-1017	1	1 1/8	1.125	28.6	9/32	0.281	7.1	11/32	0.344	8.7	3/32	0.094	2.4	15/16	0.938	23.8			
E-763	1	9/16	0.563	14.3	9/32	0.281	7.1	1/4	0.250	6.4	1/16	0.063	1.6	3/8	0.375	9.5			
E-190	1	11/16	0.688	17.5	9/32	0.281	7.1	7/16	0.438	11.1	1/4	0.250	6.4	15/32	0.469	11.9			
E-9661	3	9/16	0.563	14.3	9/32	0.281	7.1	3/8	0.375	9.5	5/64	0.078	2.0	13/32	0.406	10.3			
E-2203	1	37/64	0.578	14.7	9/32	0.281	7.1	5/16	0.313	7.9	1/16	0.055	1.4	25/64	0.391	9.9			
E-2211	1	9/16	0.563	14.3	9/32	0.281	7.1	1/4	0.250	6.4	1/16	0.063	1.6	13/32	0.406	10.3			
E-2213	1	37/64	0.578	14.7	9/32	0.281	7.1	5/16	0.313	7.9	1/16	0.055	1.4	7/16	0.437	11.1			
E-2214	1	37/64	0.578	14.7	9/32	0.281	7.1	5/16	0.313	7.9	1/16	0.055	1.4	15/32	0.469	11.9			
E-3305	3	39/55	0.709	18.0	15/49	0.306	7.8	21/41	0.512	13.0	1/18	0.056	1.4	21/41	0.512	13.0			
E-2511	5	1	1.000	25.4	5/16	0.313	7.9	19/32	0.594	15.1	5/32	0.156	4.0	7/16	0.438	11.1	5/8	0.625	15.9
E-837	1	5/8	0.625	15.9	5/16	0.313	7.9	1/4	0.250	6.4	1/16	0.063	1.6	27/64	0.422	10.7			
E-1135	3	5/8	0.625	15.9	5/16	0.313	7.9	11/32	0.344	8.7	1/16	0.063	1.6	7/16	0.438	11.1			
E-9138	5	5/8	0.625	15.9	5/16	0.313	7.9	9/32	0.281	7.1	3/16	0.188	4.8	29/64	0.453	11.5	17/32	0.531	13.5
E-909	1	9/16	0.563	14.3	5/16	0.313	7.9	3/16	0.188	4.8	1/16	0.063	1.6	15/32	0.469	11.9			
E-869	2	5/8	0.625	15.9	5/16	0.313	7.9	1/2	0.500	12.7	3/16	0.188	4.8	1/2	0.500	12.7			
E-9115	1	5/8	0.625	15.9	5/16	0.313	7.9	1/4	0.250	6.4	1/16	0.063	1.6	1/2	0.500	12.7			
E-924	3	3/4	0.750	19.1	5/16	0.313	7.9	3/8	0.375	9.5	1/8	0.125	3.2	1/2	0.500	12.7			
E-1155	4	3/4	0.750	19.1	5/16	0.313	7.9	7/16	0.438	11.1	1/16	0.063	1.6	1/2	0.500	12.7	1/4	0.250	6.4
E-2857	1	1	1.000	25.4	5/16	0.313	7.9	3/8	0.375	9.5	1/8	0.125	3.2	3/4	0.750	19.1			
E-263	1	9/16	0.563	14.3	5/16	0.313	7.9	3/16	0.188	4.8	1/16	0.063	1.6	7/16	0.438	11.1			
E-505	1	5/8	0.625	15.9	5/16	0.313	7.9	9/32	0.281	7.1	1/16	0.063	1.6	7/16	0.438	11.1			
E-2113	1	13/16	0.813	20.6	5/16	0.313	7.9	5/16	0.313	7.9	1/16	0.063	1.6	9/16	0.563	14.3			
E-2280	1	1	1.000	25.4	5/16	0.313	7.9	5/16	0.313	7.9	1/16	0.063	1.6	3/4	0.750	19.1			

- Used to protect or cover through holes. Help eliminate sharp edges so your wires are protected and add aesthetic value to your application.
- 160 sizes available that will accommodate mounting holes ranging from .250" (6,4 mm) to holes as large as 2.50" (63,5 mm) diameter and panel thicknesses from .063" (1,6 mm) to .375" (9,5 mm).

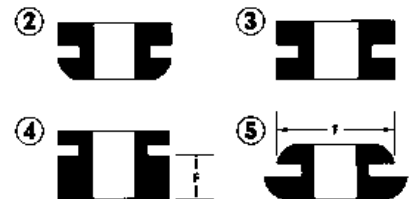
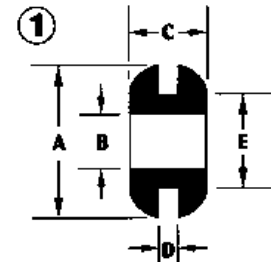

\* Indicates I.D. is chamfered \*\*Other D dimensions available \*\*\*Squared corners





# GROMMETS

By "B" Dimension

- Used to protect or cover through holes. Help eliminate sharp edges so your wires are protected and add aesthetic value to your application.
- 160 sizes available that will accommodate mounting holes ranging from .250" (6,4 mm) to holes as large as 2.50" (63,5 mm) diameter and panel thicknesses from .063" (1,6 mm) to .375" (9,5 mm).

PART NO.	Fig No.	A			B			C			D			E			F		
		Inch	Dec	MM	Inch	Dec	MM	Inch	Dec	MM	Inch	Dec	MM	Inch	Dec	MM	Inch	Dec	MM
E-2538	1	5/8	0.625	15.9	5/16	0.313	7.9	5/16	0.313	7.9	3/32	0.094	2.4	7/16	0.438	11.1			
E-2214	1	3/4	0.750	19.1	5/16	0.313	7.9	11/32	0.344	8.7	3/32	0.094	2.4	15/32	0.469	11.9			
E-2856	1	13/16	0.813	20.6	5/16	0.313	7.9	3/8	0.375	9.5	1/8	0.125	3.2	9/16	0.563	14.3			
E-705	1	13/16	0.813	20.6	5/16	0.313	7.9	3/8	0.375	9.5	2 1/16	2.063	52.4	9/16	0.563	14.3			
E-2756	1	13/16	0.813	20.6	5/16	0.313	7.9	7/16	0.438	11.1	3/16	0.188	4.8	9/16	0.563	14.3			
E-2757	1	1	1.000	25.4	5/16	0.313	7.9	7/16	0.438	11.1	3/16	0.188	4.8	3/4	0.750	19.1			
E-2556	1	13/16	0.813	20.6	5/16	0.313	7.9	1/2	0.500	12.7	1/4	0.250	6.4	9/16	0.563	14.3			
E-2557	1	1	1.000	25.4	5/16	0.313	7.9	1/2	0.500	12.7	1/4	0.250	6.4	3/4	0.750	19.1			
E-2472	5	1	1.000	25.4	5/16	0.313	7.9	5/8	0.625	15.9	3/16	0.188	4.8	7/16	0.438	11.1	5/8	0.625	15.9
E-324	1	19/32	0.594	15.1	5/16	0.313	7.9	3/8	0.375	9.5	1/8	0.125	3.2	7/16	0.437	11.1			
E-2252	1	5/8	0.625	15.9	5/16	0.313	7.9	1/4	0.250	6.4	1/16	0.063	1.6	7/16	0.437	11.1			
E-2352	1	5/8	0.625	15.9	5/16	0.313	7.9	7/32	0.219	5.6	1/32	0.031	0.8	7/16	0.437	11.1			
E-3241	1	19/32	0.594	15.1	5/16	0.313	7.9	11/32	0.344	8.7	3/32	0.937	23.8	7/16	0.437	11.1			
E-3378	1	41/64	0.638	16.2	5/16	0.313	7.9	21/64	0.320	8.1	3/32	0.096	2.4	7/16	0.446	11.3			
E-2667	1	3/4	0.750	19.1	5/16	0.313	7.9	11/32	0.344	8.7	3/32	0.094	2.4	15/32	0.469	11.9			
E-2690	1	3/4	0.750	19.1	5/16	0.313	7.9	21/64	0.330	8.4	3/32	0.091	2.3	31/64	0.484	12.3			
E-3370	5	49/32	1.530	38.9	5/16	0.313	7.9	23/64	0.357	9.1	17/64	0.255	6.5	1/2	0.495	12.6	49/64	0.765	19.4
E-1223	5	7/8	0.875	22.2	5/16	0.313	7.9	7/16	0.438	11.1	3/32	0.094	2.4	1/2	0.500	12.7	5/8	0.625	15.9
E-2033	4	11/16	0.688	17.5	5/16	0.313	7.9	27/64	0.422	10.7	5/64	0.078	2.0	1/2	0.500	12.7	1/4	0.250	6.4
E-3261	1	3/4	0.750	19.1	5/16	0.313	7.9	9/16	0.563	14.3	3/16	0.188	4.8	17/32	0.531	13.5			
E-3262	1	3/4	0.750	19.1	5/16	0.313	7.9	7/16	0.438	11.1	1/16	0.063	1.6	17/32	0.531	13.5			
E-2660	3	5/8	0.625	15.9	5/16	0.313	7.9	3/16	0.188	4.8	1/16	0.063	1.6	9/16	0.563	14.3			
AN931-5-9	1	13/16	0.813	20.6	5/16	0.313	7.9	5/16	0.313	7.9	1/16	0.063	1.6	9/16	0.563	14.3			
E-2274-AC	1	7/8	0.875	22.2	5/16	0.313	7.9	5/16	0.313	7.9	1/16	0.063	1.6	5/8	0.625	15.9			
E-2272	1	7/8	0.875	22.2	5/16	0.313	7.9	11/32	0.344	8.7	3/32	0.094	2.4	11/16	0.688	17.5			
E-2125	1	1	1.000	25.4	5/16	0.313	7.9	11/32	0.344	8.7	3/32	0.094	2.4	3/4	0.750	19.1			
AN931-5-12	1	1	1.000	25.4	5/16	0.313	7.9	5/16	0.313	7.9	1/16	0.063	1.6	3/4	0.750	19.1			

\* Indicates I.D. is chamfered    \*\*Other D dimensions available    \*\*\*Squared corners

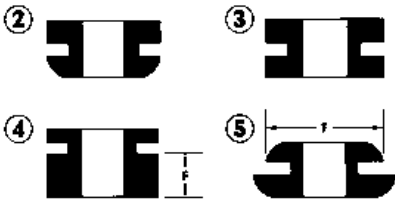
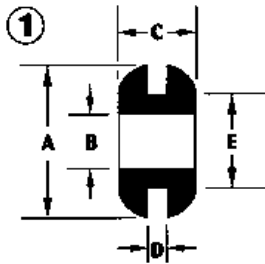

# GROMMETS

## By "B" Dimension



PART NO.	Fig No.	A			B			C			D			E			F		
		Inch	Dec	MM	Inch	Dec	MM	Inch	Dec	MM	Inch	Dec	MM	Inch	Dec	MM	Inch	Dec	MM
E-1113	1	1 1/16	1.063	27.0	5/16	0.313	7.9	1/2	0.500	12.7	5/32	0.156	4.0	3/4	0.750	19.1			
E-1112	3	1 1/16	1.063	27.0	5/16	0.313	7.9	5/16	0.313	7.9	1/16	0.063	1.6	13/16	0.813	20.6			
E-226	1	23/32	0.719	18.3	21/64	0.328	8.3	5/16	0.313	7.9	1/16	0.063	1.6	9/16	0.563	14.3			
E-2934	4	7/8	0.875	22.2	21/64	0.328	8.3	15/32	0.469	11.9	1/16	0.063	1.6	5/8	0.625	15.9	1/4	0.250	6.4
E-2128	5	47/64	0.740	18.8	21/64	0.328	8.3	23/32	0.719	18.3	17/64	0.265	6.7	7/16	0.437	11.1	19/32	0.595	15.1
E-3324	3	25/32	0.788	20.0	21/64	0.328	8.3	35/64	0.551	14.0	5/64	0.079	2.0	35/64	0.552	14.0			
E-3359	3	15/16	0.937	23.8	21/64	0.328	8.3	17/32	0.531	13.5	5/32	0.157	4.0	5/8	0.626	15.9			
E-2004	1	25/32	0.781	19.8	11/32	0.344	8.7	1/4	0.250	6.4	1/16	0.063	1.6	17/32	0.531	13.5			
E-2117	3	5/8	0.625	15.9	11/32	0.344	8.7	19/64	0.297	7.5	3/16	0.188	4.8	33/64	0.516	13.1			
E-2674	4	3/4	0.750	19.1	23/64	0.359	9.1	41/64	0.641	16.3	1/8	0.125	3.2	31/64	0.484	12.3	3/8	0.375	9.5
E-2635	5	19/32	0.590	15.0	23/64	0.359	9.1	5/32	0.156	4.0	1/32	0.031	0.8	31/64	0.480	12.2	33/64	0.510	13.0
E-910	3	5/8	0.625	15.9	3/8	0.375	9.5	1/4	0.250	6.4	1/16	0.063	1.6	1/2	0.500	12.7			
E-9116	1	13/16	0.813	20.6	3/8	0.375	9.5	3/8	0.375	9.5	3/32	0.094	2.4	1/2	0.500	12.7			
E-925	3	11/16	0.688	17.5	3/8	0.375	9.5	7/16	0.438	11.1	1/4	0.250	6.4	1/2	0.500	12.7			
E-929	1	3/4	0.750	19.1	3/8	0.375	9.5	3/4	0.750	19.1	1/2	0.500	12.7	9/16	0.563	14.3			
E-814	1	7/8	0.875	22.2	3/8	0.375	9.5	11/32	0.344	8.7	1/16	0.063	1.6	5/8	0.625	15.9			
E-8141	1	7/8	0.875	22.2	3/8	0.375	9.5	13/32	0.406	10.3	1/8	0.125	3.2	5/8	0.625	15.9			
E-945	5	1	1.000	25.4	3/8	0.375	9.5	13/32	0.406	10.3	9/64	0.141	3.6	11/16	0.688	17.5	7/8	0.875	22.2
E-9230	4	1 1/4	1.250	31.8	3/8	0.375	9.5	45/64	0.703	17.9	1/8	0.125	3.2	3/4	0.750	19.1	3/8	0.375	9.5
E-230-AT	1	5/8	0.625	15.9	3/8	0.375	9.5	1/4	0.250	6.4	1/16	0.063	1.6	1/2	0.500	12.7			
E-1724	1	11/16	0.688	17.5	3/8	0.375	9.5	9/32	0.281	7.1	1/16	0.063	1.6	1/2	0.500	12.7			
E-2281	1	7/8	0.875	22.2	3/8	0.375	9.5	5/16	0.313	7.9	1/16	0.063	1.6	5/8	0.625	15.9			
E-2264	1	7/8	0.875	22.2	3/8	0.375	9.5	11/32	0.344	8.7	1/16	0.063	1.6	5/8	0.625	15.9			
E-2299	1	1 1/4	1.250	31.8	3/8	0.375	9.5	1/4	0.250	6.4	1/16	0.063	1.6	1	1.000	25.4			
E-896	1	13/16	0.813	20.6	3/8	0.375	9.5	3/8	0.375	9.5	3/16	0.188	4.8	9/16	0.563	14.3			
E-828	1	3/7	0.429	10.9	3/8	0.375	9.5	1/2	0.500	12.7	1/4	0.250	6.4	1/2	0.500	12.7			
E-2558	1	7/8	0.875	22.2	3/8	0.375	9.5	1/2	0.500	12.7	1/4	0.250	6.4	5/8	0.625	15.9			
E-2596	1	3/4	0.750	19.1	3/8	0.375	9.5	3/4	0.750	19.1	3/8	0.375	9.5	9/16	0.563	14.3			
E-224	2	5/8	0.625	15.9	3/8	0.375	9.5	1/4	0.250	6.4	1/16	0.063	1.6	1/2	0.500	12.7			
E-225	1	5/8	0.625	15.9	3/8	0.375	9.5	1/4	0.250	6.4	1/16	0.063	1.6	1/2	0.500	12.7			
E-325	2	5/8	0.625	15.9	3/8	0.375	9.5	5/16	0.313	7.9	1/8	0.125	3.2	1/2	0.500	12.7			
AN930-1	1	11/16	0.688	17.5	3/8	0.375	9.5	9/32	0.281	7.1	1/16	0.063	1.6	1/2	0.500	12.7			
E-2035	4	11/16	0.688	17.5	3/8	0.375	9.5	19/64	0.297	7.5	3/64	0.050	1.3	1/2	0.500	12.7	3/16	0.375	9.5
E-2250	1	5/8	0.625	15.9	3/8	0.375	9.5	1/4	0.250	6.4	3/64	0.050	1.3	1/2	0.500	12.7			
E-2967	1	3/4	0.750	19.1	3/8	0.375	9.5	1/2	0.500	12.7	1/4	0.250	6.4	1/2	0.500	12.7			
E-3373	3	41/64	0.638	16.2	3/8	0.375	9.5	13/32	0.412	10.5	1/8	0.126	3.2	1/2	0.510	13.0			

- Used to protect or cover through holes. Help eliminate sharp edges so your wires are protected and add aesthetic value to your application.
- 160 sizes available that will accommodate mounting holes ranging from .250" (6,4 mm) to holes as large as 2.50" (63,5 mm) diameter and panel thicknesses from .063" (1,6 mm) to .375" (9,5 mm).

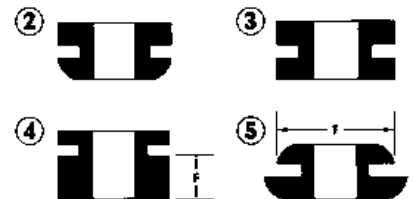
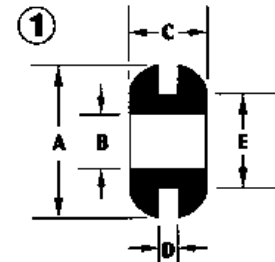

\* Indicates I.D. is chamfered    \*\*Other D dimensions available    \*\*\*Squared corners





# GROMMETS

By "B" Dimension

- Used to protect or cover through holes. Help eliminate sharp edges so your wires are protected and add aesthetic value to your application.
- 160 sizes available that will accommodate mounting holes ranging from .250" (6,4 mm) to holes as large as 2.50" (63,5 mm) diameter and panel thicknesses from .063" (1,6 mm) to .375" (9,5 mm).

PART NO.	Fig No.	A			B			C			D			E			F		
		Inch	Dec	MM	Inch	Dec	MM	Inch	Dec	MM	Inch	Dec	MM	Inch	Dec	MM	Inch	Dec	MM
E-1109	S**	3/4	0.750	19.1	3/8	0.375	9.5	1/2	0.500	12.7	1/8	0.125	3.2	17/32	0.531	13.5			
E-2258	1	5/8	0.625	15.9	3/8	0.375	9.5	11/32	0.344	8.7	1/16	0.063	1.6	17/32	0.531	13.5			
E-232	1	13/16	0.813	20.6	3/8	0.375	9.5	3/16	0.313	7.9	1/16	0.063	1.6	9/16	0.563	14.3			
AN930-2	1	3/4	0.750	19.1	3/8	0.375	9.5	3/8	0.375	9.5	1/16	0.063	1.6	9/16	0.563	14.3			
AN930-3	1	3/4	0.750	19.1	3/8	0.375	9.5	3/4	0.750	19.1	3/8	0.375	9.5	9/16	0.563	14.3			
E-2989	1	13/16	0.813	20.6	3/8	0.375	9.5	3/8	0.375	9.5	3/16	0.188	4.8	9/16	0.563	14.3			
E-2123	3	3/4	0.750	19.1	3/8	0.375	9.5	9/16	0.563	14.3	3/8	0.375	9.5	19/32	0.594	15.1			
E-2271	1	7/8	0.875	22.2	3/8	0.375	9.5	5/16	0.313	7.9	1/16	0.063	1.6	5/8	0.625	15.9			
E-2273-AC	3	15/16	0.938	23.8	3/8	0.375	9.5	17/32	0.531	13.5	5/32	0.156	4.0	5/8	0.625	15.9			
E-2275	1	7/8	0.875	22.2	3/8	0.375	9.5	5/16	0.313	7.9	1/16	0.070	1.8	5/8	0.625	15.9			
E-2994	1	15/16	0.938	23.8	3/8	0.375	9.5	3/8	0.375	9.5	1/8	0.125	3.2	11/16	0.688	17.5			
AN931-6-16	1	1 1/4	1.250	31.8	3/8	0.375	9.5	1/4	0.250	6.4	1/16	0.063	1.6	1	1.000	25.4			
E-2590	5	18/25	0.720	18.3	2/5	0.400	10.2	3/13	0.230	5.8	1/25	0.040	1.0	4/9	0.445	11.3	44/83	0.530	13.5
E-3342	1	11/16	0.688	17.5	13/32	0.406	10.3	1/4	0.250	6.4	3/32	0.094	2.4	1/2	0.500	12.7			
E-911	1	11/16	0.688	17.5	13/32	0.406	10.3	1/4	0.250	6.4	1/16	0.063	1.6	1/2	0.500	12.7			
E-914	3	13/16	0.813	20.6	13/32	0.406	10.3	5/16	0.313	7.9	1/16	0.063	1.6	9/16	0.563	14.3			
E-811	1	5/8	0.625	15.9	7/16	0.438	11.1	9/32	0.281	7.1	3/32	0.094	2.4	7/16	0.438	11.1			
E-913	1	3/4	0.750	19.1	7/16	0.438	11.1	1/4	0.250	6.4	1/16	0.063	1.6	9/16	0.563	14.3			
E-918	1	3/4	0.750	19.1	7/16	0.438	11.1	3/8	0.375	9.5	1/8	0.125	3.2	9/16	0.563	14.3			
E-2282	1	15/16	0.938	23.8	7/16	0.438	11.1	5/16	0.313	7.9	1/16	0.063	1.6	11/16	0.688	17.5			
E-1101	1	3/4	0.750	19.1	7/16	0.438	11.1	1/4	0.250	6.4	1/16	0.063	1.6	9/16	0.563	14.3			
E-2037	4	3/4	0.750	19.1	7/16	0.438	11.1	1/4	0.250	6.4	1/16	0.063	1.6	9/16	0.563	14.3	5/32	0.156	4.0
E-2263	1	3/4	0.750	19.1	7/16	0.438	11.1	1/4	0.250	6.4	5/64	0.080	2.0	9/16	0.563	14.3			
E-2971	3	11/16	0.688	17.5	7/16	0.438	11.1	3/8	0.375	9.5	3/16	0.188	4.8	9/16	0.563	14.3			
E-2114	1	3/4	0.750	19.1	7/16	0.438	11.1	3/8	0.375	9.5	3/64	0.050	1.3	19/32	0.594	15.1			
AN931-7-11	1	15/16	0.938	23.8	7/16	0.438	11.1	5/16	0.313	7.9	1/16	0.063	1.6	11/16	0.688	17.5			
E-917	1	1	1.000	25.4	1/2	0.500	12.7	9/32	0.281	7.1	3/32	0.094	2.4	3/4	0.750	19.1			
E-932	4	1 1/4	1.250	31.8	1/2	0.500	12.7	1/2	0.500	12.7	3/32	0.094	2.4	3/4	0.750	19.1	9/32	0.281	7.1
E-2283	1	1 1/16	1.063	27.0	1/2	0.500	12.7	5/16	0.313	7.9	1/16	0.063	1.6	13/16	0.813	20.6			

\* Indicates I.D. is chamfered    \*\*Other D dimensions available    \*\*\*Squared corners

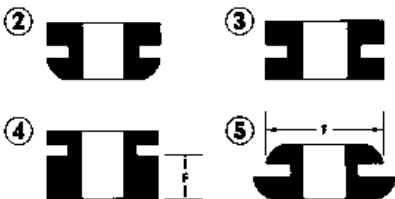
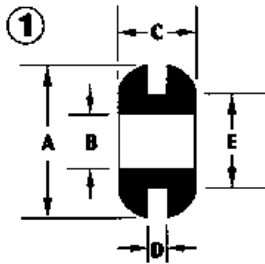

# GROMMETS

By "B" Dimension



PART NO.	Fig No.	A			B			C			D			E			F		
		Inch	Dec	MM	Inch	Dec	MM	Inch	Dec	MM	Inch	Dec	MM	Inch	Dec	MM	Inch	Dec	MM
E-2426-AT	1	1 1/4	1.250	31.8	1/2	0.500	12.7	1/4	0.250	6.4	1/16	0.063	1.6	1	1.000	25.4			
E-2284	1	1 1/2	1.500	38.1	1/2	0.500	12.7	1/4	0.250	6.4	1/16	0.063	1.6	1 1/4	1.250	31.8			
E-2339	1	1 3/4	1.750	44.5	1/2	0.500	12.7	3/8	0.375	9.5	1/16	0.063	1.6	1 7/16	1.438	36.5			
E-452	1	7/8	0.875	22.2	1/2	0.500	12.7	11/32	0.344	8.7	3/32	0.094	2.4	3/4	0.750	19.1			
E-1862	1	31/32	0.969	24.6	1/2	0.500	12.7	9/32	0.281	7.1	3/32	0.094	2.4	3/4	0.750	19.1			
E-653	1	1	1.000	25.4	1/2	0.500	12.7	1/2	0.500	12.7	1/8	0.125	3.2	3/4	0.750	19.1			
E-2561	1	1 1/16	1.063	27.0	1/2	0.500	12.7	1/2	0.500	12.7	1/4	0.250	6.4	13/16	0.813	20.6			
E-807-AT	1	1	1.000	25.4	1/2	0.500	12.7	5/8	0.625	15.9	3/8	0.375	9.5	3/4	0.750	19.1			
E-230-AC	1	13/16	0.813	20.6	1/2	0.500	12.7	9/32	0.281	7.1	1/16	0.063	1.6	5/8	0.625	15.9			
E-231	2	13/16	0.813	20.6	1/2	0.500	12.7	9/32	0.281	7.1	1/16	0.063	1.6	5/8	0.625	15.9			
E-330	2	13/16	0.813	20.6	1/2	0.500	12.7	11/32	0.344	8.7	1/8	0.125	3.2	5/8	0.625	15.9			
E-2984	1	1	1.000	25.4	1/2	0.500	12.7	1/2	0.500	12.7	1/8	0.125	3.2	3/4	0.750	19.1			
AN930-4	1	1	1.000	25.4	1/2	0.500	12.7	9/32	0.281	7.1	3/32	0.094	2.4	3/4	0.750	19.1			
AN930-41	1	1	1.000	25.4	1/2	0.500	12.7	1/4	0.250	6.4	1/16	0.063	1.6	3/4	0.750	19.1			
AN930-42	1	1	1.000	25.4	1/2	0.500	12.7	5/16	0.313	7.9	1/8	0.125	3.2	3/4	0.750	19.1			
E-2648	3	1	1.000	25.4	1/2	0.500	12.7	7/16	0.438	11.1	3/16	0.188	4.8	3/4	0.750	19.1			
E-2933	1	1	1.000	25.4	1/2	0.500	12.7	5/8	0.625	15.9	3/8	0.375	9.5	3/4	0.750	19.1			
E-1102	1	1 1/16	1.063	27.0	1/2	0.500	12.7	5/16	0.313	7.9	1/16	0.063	1.6	13/16	0.813	20.6			
E-1110	1	1 1/16	1.063	27.0	1/2	0.500	12.7	11/32	0.344	8.7	1/8	0.125	3.2	13/16	0.813	20.6			
E-2654	3	1 1/16	1.063	27.0	1/2	0.500	12.7	13/16	0.813	20.6	1/2	0.500	12.7	13/16	0.813	20.6			
E-1118	1	1 1/8	1.125	28.6	1/2	0.500	12.7	5/16	0.302	7.7	1/16	0.063	1.6	7/8	0.875	22.2			
E-1108	1	1 1/4	1.250	31.8	1/2	0.500	12.7	1/4	0.250	6.4	1/16	0.063	1.6	1	1.000	25.4			
E-2983	1	1 1/4	1.250	31.8	1/2	0.500	12.7	5/16	0.313	7.9	1/8	0.125	3.2	1	1.000	25.4			
AN931-8-20	1	1 1/2	1.500	38.1	1/2	0.500	12.7	1/4	0.250	6.4	1/16	0.063	1.6	1 1/4	1.250	31.8			
E-2917	1	1 1/4	1.250	31.8	9/16	0.563	14.3	3/8	0.375	9.5	5/32	0.156	4.0	7/8	0.875	22.2			
E-915	1	1	1.000	25.4	9/16	0.563	14.3	5/16	0.313	7.9	1/16	0.063	1.6	3/4	0.750	19.1			
E-2295	1	1 1/16	1.063	27.0	9/16	0.563	14.3	5/16	0.313	7.9	1/16	0.063	1.6	13/16	0.813	20.6			
E-99	1	1 9/32	1.281	32.5	9/16	0.563	14.3	3/8	0.375	9.5	1/16	0.063	1.6	1 3/32	1.094	27.8			
E-2512	1	1 1/16	1.063	27.0	9/16	0.563	14.3	7/16	0.438	11.1	3/16	0.188	4.8	7/8	0.875	22.2			
E-2563	1	1 1/16	1.063	27.0	9/16	0.563	14.3	1/2	0.500	12.7	1/4	0.250	6.4	13/16	0.813	20.6			
E-2513	1	1 1/16	1.063	27.0	9/16	0.563	14.3	5/8	0.625	15.9	3/8	0.375	9.5	7/8	0.875	22.2			
E-2406-AT	1	1 1/8	1.125	28.6	9/16	0.563	14.3	1 1/4	1.250	31.8	1	1.000	25.4	13/16	0.813	20.6			
AN931-9-13	1	1 1/16	1.063	27.0	9/16	0.563	14.3	5/16	0.313	7.9	1/16	0.063	1.6	13/16	0.813	20.6			
E-2625	5-1	1 3/16	1.188	30.2	5/8	0.625	15.9	5/16	0.313	8.0	1/16	0.063	1.6	7/8	0.875	22.2	1 3/32	1.094	27.8
E-2904	1-1	15/16	0.938	23.8	5/8	0.625	15.9	9/32	0.281	7.1	3/32	0.094	2.4	3/4	0.750	19.1			
E-3335	5-1	1 1/2	1.500	38.1	5/8	0.625	15.9	5/8	0.625	15.9	1/8	0.125	3.2	1 5/32	1.156	29.4	1 3/8	1.376	35.0
E-1021	1	1 1/8	1.125	28.6	5/8	0.625	15.9	11/32	0.344	8.7	3/32	0.094	2.4	7/8	0.875	22.2			
E-1030	1	1 1/8	1.125	28.6	5/8	0.625	15.9	3/8	0.375	9.5	1/8	0.125	3.2	7/8	0.875	22.2			
E-2285	1	1 1/8	1.125	28.6	5/8	0.625	15.9	5/16	0.313	7.9	1/16	0.063	1.6	7/8	0.875	22.2			

- Used to protect or cover through holes. Help eliminate sharp edges so your wires are protected and add aesthetic value to your application.
- 160 sizes available that will accommodate mounting holes ranging from .250" (6,4 mm) to holes as large as 2.50" (63,5 mm) diameter and panel thicknesses from .063" (1,6 mm) to .375" (9,5 mm).

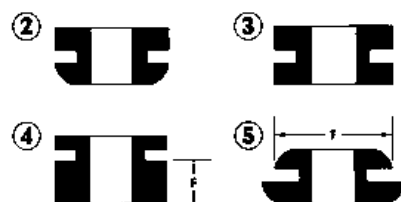
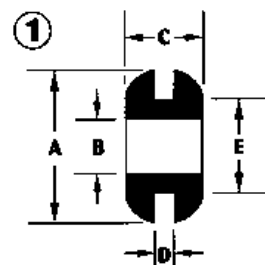

\* Indicates I.D. is chamfered    \*\*Other D dimensions available    \*\*\*Squared corners





# GROMMETS

By "B" Dimension

- Used to protect or cover through holes. Help eliminate sharp edges so your wires are protected and add aesthetic value to your application.
- 160 sizes available that will accommodate mounting holes ranging from .250" (6,4 mm) to holes as large as 2.50" (63,5 mm) diameter and panel thicknesses from .063" (1,6 mm) to .375" (9,5 mm).

PART NO.	Fig No.	A			B			C			D			E			F		
		Inch	Dec	MM	Inch	Dec	MM	Inch	Dec	MM	Inch	Dec	MM	Inch	Dec	MM	Inch	Dec	MM
E-2296	1	1 1/2	1.500	38.1	5/8	0.625	15.9	1/4	0.250	6.4	1/16	0.063	1.6	1 1/4	1.250	31.8			
E-2497	1	1 1/4	1.250	31.8	5/8	0.625	15.9	7/16	0.438	11.1	3/32	0.094	2.4	31/32	0.969	24.6			
E-2864	1	1 1/8	1.125	28.6	5/8	0.625	15.9	3/8	0.375	9.5	1/8	0.125	3.2	7/8	0.875	22.2			
E-501	1	1 1/8	1.125	28.6	5/8	0.625	15.9	7/16	0.438	11.1	1/8	0.125	3.2	29/32	0.906	23.0			
E-2764	1	1 1/8	1.125	28.6	5/8	0.625	15.9	7/16	0.438	11.1	3/16	0.188	4.8	7/8	0.875	22.2			
E-2564	1	1 1/8	1.125	28.6	5/8	0.625	15.9	1/2	0.500	12.7	1/4	0.250	6.4	7/8	0.875	22.2			
E-494	1	1 1/8	1.125	28.6	5/8	0.625	15.9	5/8	0.625	15.9	5/16	0.313	7.9	29/32	0.906	23.0			
E-1103	1	1 1/8	1.125	28.6	5/8	0.625	15.9	5/16	0.313	7.9	1/16	0.063	1.6	7/8	0.875	22.2			
AN931-10-20	1	1 1/2	1.500	38.1	5/8	0.625	15.9	1/4	0.250	6.4	1/16	0.063	1.6	1 1/4	1.250	31.8			
E-873	1	1 1/16	1.063	27.0	41/64	0.641	16.3	23/64	0.359	9.1	7/64	0.109	2.8	57/64	0.891	22.6			
E-1032	1	1 5/16	1.313	33.3	11/16	0.688	17.5	3/8	0.375	9.5	5/64	0.078	2.0	1	1.000	25.4			
E-2273-AT	1	1 5/16	1.313	33.3	11/16	0.688	17.5	3/8	0.375	9.5	1/16	0.063	1.6	1	1.000	25.4			
E-2866	1	1 5/16	1.313	33.3	11/16	0.688	17.5	7/16	0.438	11.1	1/8	0.125	3.2	1	1.000	25.4			
E-2331	1	1 5/16	1.313	33.3	11/16	0.688	17.5	1/2	0.500	12.7	3/16	0.188	4.8	1	1.000	25.4			
E-2566	1	1 5/16	1.313	33.3	11/16	0.688	17.5	9/16	0.563	14.3	1/4	0.250	6.4	1	1.000	25.4			
E-2301-AC	1	1 1/16	1.063	27.0	11/16	0.688	17.5	1/4	0.250	6.4	1/16	0.063	1.6	13/16	0.813	20.6			
AN931-11-16	1	1 5/16	1.313	33.3	11/16	0.688	17.5	3/8	0.375	9.5	1/16	0.063	1.6	1	1.000	25.4			
E-2651	1	1 3/4	1.750	44.5	11/16	0.688	17.5	1/2	0.500	12.7	1/8	0.125	3.2	1 3/8	1.375	34.9			
E-933	1	1 9/32	1.281	32.5	23/32	0.719	18.3	3/8	0.375	9.5	3/32	0.094	2.4	1 1/16	1.063	27.0			
E-1018	1	1 1/8	1.125	28.6	3/4	0.750	19.1	3/8	0.375	9.5	1/8	0.125	3.2	7/8	0.875	22.2			
E-1020	1	1 1/8	1.125	28.6	3/4	0.750	19.1	11/32	0.344	8.7	3/32	0.094	2.4	7/8	0.875	22.2			
E-1022	1	1 1/8	1.125	28.6	3/4	0.750	19.1	5/16	0.313	7.9	1/16	0.063	1.6	7/8	0.875	22.2			
E-1029	1	1 1/8	1.125	28.6	3/4	0.750	19.1	11/32	0.344	8.7	3/32	0.094	2.4	15/16	0.938	23.8			
E-1027	1	1 1/8	1.125	28.6	3/4	0.750	19.1	5/16	0.313	7.9	3/32	0.094	2.4	15/16	0.938	23.8			
E-935	1	1 5/8	1.625	41.3	3/4	0.750	19.1	5/16	0.313	7.9	1/16	0.063	1.6	1 3/32	1.094	27.8			
E-936	1	1 1/2	1.500	38.1	3/4	0.750	19.1	5/16	0.313	7.9	3/32	0.094	2.4	1 1/8	1.125	28.6			
E-2196	1	1 1/8	1.125	28.6	3/4	0.750	19.1	1/4	0.250	6.4	1/16	0.063	1.6	15/16	0.938	23.8			
E-804	1	1 3/8	1.375	34.9	3/4	0.750	19.1	3/8	0.375	9.5	1/16	0.063	1.6	1 1/16	1.063	27.0			
E-2274-AT	1	1 5/8	1.625	41.3	3/4	0.750	19.1	1/4	0.250	6.4	1/16	0.063	1.6	1 1/4	1.250	31.8			

\* Indicates I.D. is chamfered    \*\*Other D dimensions available    \*\*\*Squared corners

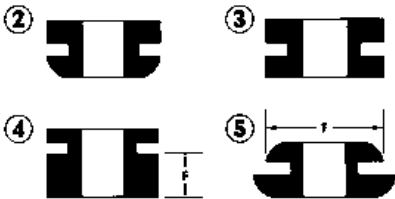
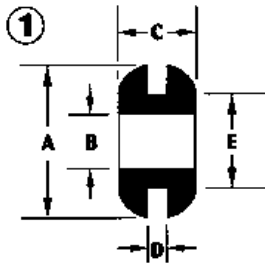



# GROMMETS

By "B" Dimension



PART NO.	Fig No.	A			B			C			D			E			F		
		Inch	Dec	MM	Inch	Dec	MM	Inch	Dec	MM	Inch	Dec	MM	Inch	Dec	MM	Inch	Dec	MM
E-2275-AT	1	1 13/16	1.813	46.0	3/4	0.750	19.1	3/8	0.375	9.5	1/16	0.063	1.6	1 7/16	1.438	36.5			
E-2867	1	1 3/8	1.375	34.9	3/4	0.750	19.1	7/16	0.438	11.1	1/8	0.125	3.2	1 1/16	1.063	27.0			
E-2868	1	1 5/8	1.625	41.3	3/4	0.750	19.1	5/16	0.313	7.9	1/8	0.125	3.2	1 1/4	1.250	31.8			
E-2767	1	1 3/8	1.375	34.9	3/4	0.750	19.1	1/2	0.500	12.7	3/16	0.188	4.8	1 1/16	1.063	27.0			
E-2567	1	1 3/8	1.375	34.9	3/4	0.750	19.1	9/16	0.563	14.3	1/4	0.250	6.4	1 1/16	1.063	27.0			
E-2568	1	1 5/8	1.625	41.3	3/4	0.750	19.1	7/16	0.438	11.1	1/4	0.250	6.4	1 1/4	1.250	31.8			
E-1117†	1	1 1/8	1.125	28.6	3/4	0.750	19.1	9/32	0.281	7.1	1/16	0.063	1.6	7/8	0.875	22.2			
AN931-12-17	1	1 3/8	1.375	34.9	3/4	0.750	19.1	3/8	0.375	9.5	1/16	0.063	1.6	1 1/16	1.063	27.0			
AN931-12-20	1	1 5/8	1.625	41.3	3/4	0.750	19.1	1/4	0.250	6.4	1/16	0.063	1.6	1 1/4	1.250	31.8			
AN931-12-23	1	1 13/16	1.813	46.0	3/4	0.750	19.1	3/8	0.375	9.5	1/16	0.063	1.6	1 7/16	1.438	36.5			
AN931-12-26	1	2	2.000	50.8	3/4	0.750	19.1	3/8	0.375	9.5	1/16	0.063	1.6	1 5/8	1.625	41.3			
E-1107	1	1 1/8	1.125	28.6	25/32	0.775	19.7	5/16	0.313	7.9	3/32	0.094	2.4	15/16	0.938	23.8			
E-9400	1	1 3/16	1.188	30.2	51/64	0.797	20.2	9/32	0.281	7.1	1/32	0.031	0.8	29/32	0.906	23.0			
E-9401	1	1 7/64	1.109	28.2	51/64	0.797	20.2	9/32	0.281	7.1	1/32	0.031	0.8	29/32	0.906	23.0			
E-5632	1	1 1/4	1.250	31.8	13/16	0.813	20.6	7/8	0.875	22.2	9/16	0.563	14.3	15/16	0.938	23.8			
E-1105-AC	1	1 5/32	1.160	29.5	13/16	0.813	20.6	1/4	0.250	6.4	3/64	0.046	1.2	15/16	0.938	23.8			
E-1224	2	1 3/16	1.188	30.2	13/16	0.813	20.6	25/32	0.781	19.8	1/2	0.500	12.7	15/16	0.938	23.8			
E-40210	1	1 1/4	1.250	31.8	13/16	0.813	20.6	7/8	0.875	22.2	9/16	0.563	14.3	15/16	0.938	23.8			
E-931	1	1 3/16	1.188	30.2	7/8	0.875	22.2	3/16	0.188	4.8	1/16	0.063	1.6	1	1.000	25.4			
E-1040	1	1 5/8	1.625	41.3	7/8	0.875	22.2	7/16	0.438	11.1	1/16	0.063	1.6	1 1/8	1.125	28.6			
E-2276	1	1 5/8	1.625	41.3	7/8	0.875	22.2	7/16	0.438	11.1	1/16	0.063	1.6	1 1/4	1.250	31.8			
E-2300	1	2	2.000	50.8	7/8	0.875	22.2	7/16	0.438	11.1	1/16	0.063	1.6	1 5/8	1.625	41.3			
E-1626	1	1 3/8	1.375	34.9	7/8	0.875	22.2	15/32	0.469	11.9	5/64	0.078	2.0	1 3/16	1.188	30.2			
E-2870	1	1 5/8	1.625	41.3	7/8	0.875	22.2	1/2	0.500	12.7	1/8	0.125	3.2	1 1/4	1.250	31.8			
E-1626-A	1	1 3/8	1.375	34.9	7/8	0.875	22.2	15/32	0.469	11.9	9/64	0.141	3.6	1 3/16	1.188	30.2			
E-2770	1	1 5/8	1.625	41.3	7/8	0.875	22.2	9/16	0.474	12.0	3/16	0.188	4.8	1 1/4	1.250	31.8			
E-2570	1	1 5/8	1.625	41.3	7/8	0.875	22.2	5/8	0.625	15.9	1/4	0.250	6.4	1 1/4	1.250	31.8			
E-9658	1	1 5/8	1.625	41.3	7/8	0.875	22.2	1/2	0.500	12.7	1/8	0.125	3.2	1 1/16	0.063	1.6			
E-3334	1	1 3/8	1.375	34.9	7/8	0.875	22.2	1/8	0.133	3.4	9/64	0.141	3.6	1 3/16	1.188	30.2			
AN930-21	1	1 9/16	1.563	39.7	7/8	0.875	22.2	3/4	0.750	19.1	3/16	0.188	4.8	1 1/4	1.250	31.8			
E-40050	1	1 5/8	1.625	41.3	7/8	0.875	22.2	7/16	0.438	11.1	1/16	0.063	1.6	1 1/4	1.250	31.8			
E-40080	1	1 5/8	1.625	41.3	7/8	0.875	22.2	1/2	0.500	12.7	1/8	0.125	3.2	1 1/4	1.250	31.8			
AN931-14-26	1	2	2.000	50.8	7/8	0.875	22.2	7/16	0.438	11.1	1/16	0.063	1.6	1 5/8	1.625	41.3			
E-1045	3	1 3/4	1.750	44.5	31/32	0.969	24.6	13/32	0.406	10.3	7/64	0.109	2.8	1 3/8	1.375	34.9			
E-2626	1	1 3/4	1.750	44.5	1	1.000	25.4	5/16	0.312	7.9	1/16	0.062	1.6	1 3/8	1.375	34.9			
E-1044	1	1 3/4	1.750	44.5	1	1.000	25.4	3/8	0.375	9.5	3/32	0.094	2.4	1 3/8	1.375	34.9			
E-2277	1	1 3/4	1.750	44.5	1	1.000	25.4	7/16	0.438	11.1	1/16	0.063	1.6	1 3/8	1.375	34.9			
E-2301-AT	1	2 1/4	2.250	57.2	1	1.000	25.4	7/16	0.438	11.1	1/16	0.063	1.6	1 7/8	1.875	47.6			
E-2872	1	1 3/4	1.750	44.5	1	1.000	25.4	1/2	0.500	12.7	1/8	0.125	3.2	1 3/8	1.375	34.9			

- Used to protect or cover through holes. Help eliminate sharp edges so your wires are protected and add aesthetic value to your application.
- 160 sizes available that will accommodate mounting holes ranging from .250" (6,4 mm) to holes as large as 2.50" (63,5 mm) diameter and panel thicknesses from .063" (1,6 mm) to .375" (9,5 mm).

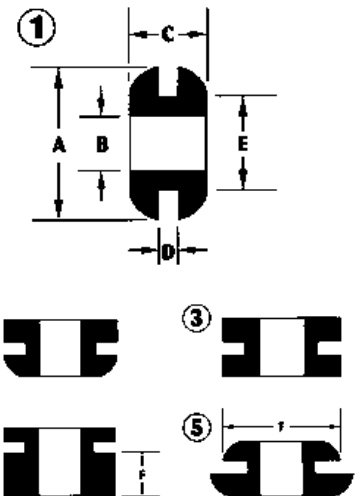

\* Indicates I.D. is chamfered    \*\*Other D dimensions available    \*\*\*Squared corners    † Note 1-3/4" Webbed ID with slit    Note 2-3/4" Webbed ID with no slit





# GROMMETS

By "B" Dimension

- Used to protect or cover through holes. Help eliminate sharp edges so your wires are protected and add aesthetic value to your application.
- 160 sizes available that will accommodate mounting holes ranging from .250" (6,4 mm) to holes as large as 2.50" (63,5 mm) diameter and panel thicknesses from .063" (1,6 mm) to .375" (9,5 mm).

PART NO.	Fig No.	A			B			C			D			E			F		
		Inch	Dec	MM	Inch	Dec	MM	Inch	Dec	MM	Inch	Dec	MM	Inch	Dec	MM	Inch	Dec	MM
E-2772	1	1 3/4	1.750	44.5	1	1.000	25.4	9/16	0.563	14.3	3/16	0.188	4.8	1 3/8	1.375	34.9			
E-2572	1	1 3/4	1.750	44.5	1	1.000	25.4	5/8	0.625	15.9	1/4	0.250	6.4	1 3/8	1.625	41.3			
E-2573	1	2 1/4	2.250	57.2	1	1.000	25.4	5/8	0.625	15.9	1/4	0.250	6.4	1 7/8	1.875	47.6			
AN931-16-22	1	1 3/4	1.750	44.5	1	1.000	25.4	7/16	0.438	11.1	1/16	0.063	1.6	1 3/8	1.375	34.9			
AN931-16-30	1	2 1/4	2.250	57.2	1	1.000	25.4	7/16	0.438	11.1	1/16	0.063	1.6	1 7/8	1.875	47.6			
E-2092	1	1 7/8	1.875	47.6	1 1/8	1.125	28.6	3/8	0.375	9.5	1	1.000	25.4	1 1/2	1.500	38.1			
E-40070	1	1 7/8	1.875	47.6	1 1/8	1.125	28.6	3/8	0.375	9.5	1/16	0.063	1.6	1 1/2	1.500	38.1			
E-40020	1	2 3/4	2.750	69.9	1 1/8	1.125	28.6	1/2	0.500	12.7	1/8	0.125	3.2	2 3/8	2.375	60.3			
E-1047	1	1 7/8	1.875	47.6	1 1/4	1.250	31.8	11/32	0.344	8.7	1/16	0.063	1.6	1 1/2	1.500	38.1			
E-994	1	1 37/64	1.578	40.1	1 1/4	1.250	31.8	63/64	0.984	25.0	25/32	0.781	19.8	127/64	1.422	36.1			
E-1048	1	1 7/8	1.875	47.6	1 1/4	1.250	31.8	3/8	0.375	9.5	3/32	0.094	2.4	1 1/2	1.500	38.1			
E-1049	1	1 7/8	1.875	47.6	1 1/4	1.250	31.8	13/32	0.406	10.3	1/8	0.125	3.2	1 1/2	1.500	38.1			
E-1056	1	2 1/8	2.125	54.0	1 1/4	1.250	31.8	3/8	0.375	9.5	3/32	0.094	2.4	1 3/4	1.750	44.5			
E-2302	1	2 3/4	2.750	69.9	1 1/4	1.250	31.8	7/16	0.438	11.1	1/16	0.063	1.6	2 3/8	2.375	60.3			
E-2574	1	2 3/4	2.750	69.9	1 1/4	1.250	31.8	5/8	0.625	15.9	1/4	0.250	6.4	2 3/8	2.375	60.3			
E-9668	1	2	2.000	50.8	1 1/4	1.250	31.8	9/16	0.563	14.3	3/16	0.188	4.8	1 5/8	1.625	41.3			
E-9669	1	2	2.000	50.8	1 1/4	1.250	31.8	3/4	0.750	19.1	3/8	0.375	9.5	1 5/8	1.625	41.3			
E-9681	1	2	2.000	50.8	1 1/4	1.250	31.8	9/16	0.563	14.3	1/4	0.250	6.4	1 5/8	1.625	41.3			
E-9649	1	2	2.000	50.8	1 1/4	1.250	31.8	1/2	0.500	12.7	1/4	0.250	6.4	1 1/2	1.500	38.1			
E-2929	1	1 7/8	1.875	47.6	1 1/4	1.250	31.8	3/8	0.375	9.5	1/16	0.063	1.6	1 5/8	1.625	41.3			
AN931-A20-38	1	2 3/4	2.750	69.9	1 1/4	1.250	31.8	1/2	0.500	12.7	1/8	0.125	3.2	2 3/8	2.375	60.3			
AN931-A20-40	1	2 7/8	2.875	73.0	1 1/4	1.250	31.8	1/2	0.500	12.7	1/8	0.125	3.2	2 1/2	2.500	63.5			
E-3366	1	1 129/32	1.913	48.6	1 9/32	1.275	32.4	37/64	0.573	14.6	1/4	0.255	6.5	121/32	1.658	42.1			
E-2634	1	2	2.000	50.8	1 19/64	1.290	32.8	7/16	0.438	11.1	1/8	0.125	3.2	1 5/8	1.625	41.3			
E-2803	1	2	2.000	50.8	1 5/16	1.313	33.3	3/8	0.375	9.5	1/16	0.063	1.6	1 5/8	1.625	41.3			
E-1064	1	2 3/8	2.375	60.3	1 1/2	1.500	38.1	3/8	0.375	9.5	3/32	0.094	2.4	2	2.000	50.8			
E-2802	1	2	2.000	50.8	1 1/2	1.500	38.1	7/16	0.438	11.1	1/8	0.125	3.2	1 5/8	1.625	41.3			
E-2278	1	2 1/8	2.125	54.0	1 1/2	1.500	38.1	7/16	0.438	11.1	1/16	0.063	1.6	1 3/4	1.750	44.5			
E-2034-AT	1	2	2.000	50.8	1 1/2	1.500	38.1	1/2	0.500	12.7	1/4	0.250	6.4	1 3/4	1.750	44.5			

\* Indicates I.D. is chamfered \*\*Other D dimensions available \*\*\*Squared corners

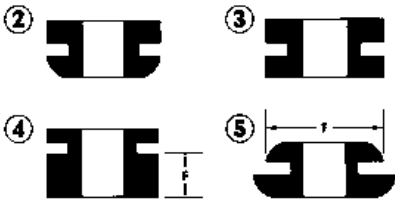
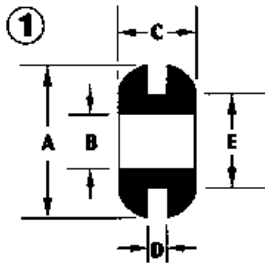

# GROMMETS

## By "B" Dimension



PART NO.	Fig No.	A			B			C			D			E			F		
		Inch	Dec	MM	Inch	Dec	MM	Inch	Dec	MM	Inch	Dec	MM	Inch	Dec	MM	Inch	Dec	MM
E-1104	1	2 1/8	2.125	54.0	1 1/2	1.500	38.1	7/16	0.438	11.1	1/16	0.063	1.6	1 3/4	1.750	44.5			
AN931-24-44	1	3 1/4	3.250	82.6	1 1/2	1.500	38.1	7/16	0.438	11.1	1/16	0.063	1.6	2 3/4	2.750	69.9			
E-9637	1	2 1/2	2.500	63.5	1 3/4	1.750	44.5	5/8	0.625	15.9	3/8	0.375	9.5	2	2.000	50.8			
E-1070-LA	1	2 5/8	2.625	66.7	1 5/8	1.875	47.6	7/16	0.438	11.1	1/16	0.063	1.6	2 1/8	2.125	54.0			
E-9703	1	2 5/8	2.625	66.7	2	2	50.8	9/16	0.563	14.3	3/16	0.188	4.8	2 1/4	2.250	57.2			
E-2575	1	2 1/8	2.125	54.0	1 1/2	1.500	38.1	5/8	0.625	15.9	1/4	0.250	6.4	1 3/4	1.750	44.5			
E-9696	3	3 3/8	3.375	85.7	2 3/8	2.375	60.3	1/2	0.500	12.7	1/8	0.125	3.2	2 3/4	2.750	69.9			
E-2805	1	2 7/8	2.875	73.0	2 1/8	2.125	54.0	7/16	0.438	11.1	1/16	0.063	1.6	2 1/2	2.500	63.5			
E-2804	1	2 7/8	2.875	73.0	2 1/8	2.125	54.0	7/16	0.438	11.1	1/8	0.125	3.2	2 1/2	2.500	63.5			

\* Indicates I.D. is chamfered    \*\*Other D dimensions available    \*\*\*Squared corners

- Used to protect or cover through holes. Help eliminate sharp edges so your wires are protected and add aesthetic value to your application.
- 160 sizes available that will accommodate mounting holes ranging from .250" (6,4 mm) to holes as large as 2.50" (63,5 mm) diameter and panel thicknesses from .063" (1,6 mm) to .375" (9,5 mm).

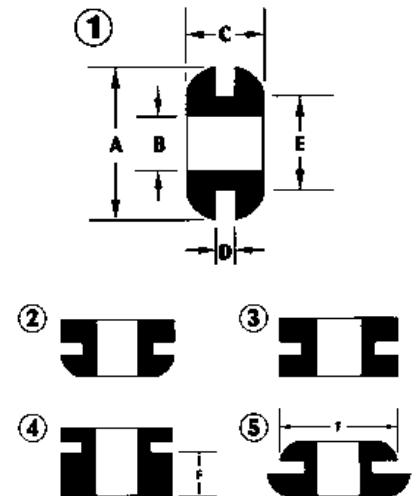



# ARMY-NAVY APPROVED AN931 GROMMETS

By "B" Dimension

- AN931 TO PROCUREMENT SPECIFICATION AN-G-21
- ARMY-NAVY STANDARD GROMMETS
- RUBBER, HOT-OIL & COOLANT RESISTANT MATERIAL SPECIFICATION: MIL-G-3036
- Purchasing grommets under this specification should include a waiver of the samples test and affidavits required by revision MIL-G-3036. Our packing slip contains a certification of material with each shipment. In the event the very strict testing requirements of revision MIL-G-3036 are required, there will be an extra charge for laboratory expenses.

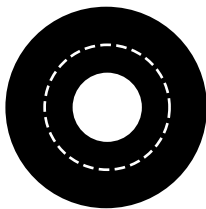
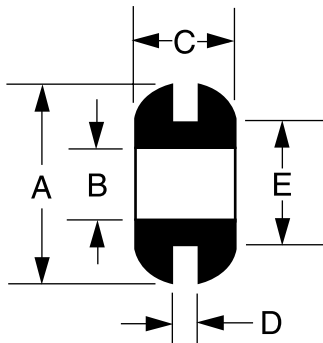

MS35489 PART NO.	AN931 PART NO.	A			B			C			D			E			ESTCO Part No.
		Inch	Dec	MM	Inch	Dec	MM	Inch	Dec	MM	Inch	Dec	MM	Inch	Dec	MM	
MS35489-2	AN931-2-9	3/4	0.75	11.1	1/8	0.125	3.2	3/16	0.187	4.7	1/16	0.062	1.6	9/16	0.562	14.3	3757-45009
MS35489-25	AN931-A2-9	3/4	0.75	11.1	1/8	0.125	3.2	1/4	0.25	6.4	1/8	0.125	3.2	9/16	0.562	14.3	3758-45009
	AN931-B2-9	3/4	0.75	19.1	1/8	0.125	3.2	5/16	0.312	7.9	3/16	0.187	4.7	9/16	0.562	14.3	
	AN931-C2-9	3/4	0.75	19.1	1/8	0.125	3.2	3/8	0.375	9.5	1/4	0.25	6.4	9/16	0.562	14.3	
MS35489-27	AN931-A3-5	7/16	0.437	19.1	3/16	0.187	4.7	1/4	0.25	6.4	1/8	0.125	3.2	5/16	0.312	7.9	2852-45009
	AN931-B3-5	7/16	0.437	19.1	3/16	0.187	4.7	5/16	0.312	7.9	3/16	0.187	4.7	5/16	0.312	7.9	
MS35489-73	AN931-C3-5	7/16	0.437	25.4	3/16	0.187	4.7	3/8	0.375	9.5	1/4	0.25	6.4	5/16	0.312	7.9	2552-45009
MS35489-134	AN931-3-9	3/4	0.75	22.2	3/16	0.187	4.7	3/16	0.187	4.7	1/16	0.062	1.6	9/16	0.562	14.3	2279-45009
MS35489-137	AN931-A3-9	3/4	0.75	22.2	3/16	0.187	4.7	1/4	0.25	6.4	1/8	0.125	3.2	9/16	0.562	14.3	2853-45009
MS35489-138	AN931-B3-9	3/4	0.75	22.2	3/16	0.187	4.7	5/16	0.312	7.9	3/16	0.187	4.7	9/16	0.562	14.3	2753-45009
	AN931-C3-9	3/4	0.75	15.9	3/16	0.187	4.7	3/8	0.37	9.5	1/4	0.25	6.4	9/16	0.56	14	
	AN931-3-5	7/16	0.437	17.4	3/16	0.187	4.7	3/16	0.187	4.7	1/16	0.062	1.6	5/16	0.312	7.9	
MS35489-4	AN931-3-5	7/16	0.437	17.4	3/16	0.187	4.7	3/16	0.187	4.7	1/16	0.062	1.6	5/16	0.312	7.9	2286-45009
MS35489-5	AN931-3-10	7/8	0.875	25.4	3/16	0.187	4.7	3/16	0.187	4.7	1/16	0.062	1.6	5/8	0.625	15.9	3759-45009
MS35489-34	AN931-A3-10	7/8	0.875	25.4	3/16	0.187	4.7	1/4	0.25	6.4	1/8	0.125	3.2	5/8	0.625	15.9	3760-45009
MS35489-63	AN931-B3-10	7/8	0.875	25.4	3/16	0.187	4.7	5/16	0.312	7.9	3/16	0.187	4.7	5/8	0.625	15.9	3760-45009
MS35489-6	AN931-C3-10	7/8	0.875	31.8	3/16	0.187	4.7	3/8	0.375	9.5	1/4	0.25	6.4	5/8	0.625	15.9	
AN931-4-7	5/8	0.625	39.7	1/4	0.25	6.4	3/16	0.187	4.7	1/16	0.062	1.6	7/16	0.437	11.1		
MS35489-35	AN931-A4-7	5/8	0.625	19.1	1/4	0.25	6.4	1/4	0.25	6.4	1/8	0.125	3.2	7/16	0.437	11.1	2854-45009
MS35489-64	AN931-B4-7	5/8	0.625	19.1	1/4	0.25	6.4	5/16	0.312	7.9	3/16	0.187	4.7	7/16	0.437	11.1	2754-45009
MS35489-93	AN931-C4-7	5/8	0.625	31.8	1/4	0.25	6.4	3/8	0.375	9.5	1/4	0.25	6.4	7/16	0.437	11.1	2554-45009
MS35489-9	AN931-5-9	13/16	0.812	15.9	5/16	0.312	7.9	5/16	0.312	7.9	1/16	0.062	1.6	9/16	0.562	14.3	2113-45009
MS35489-38	AN931A-5-9	13/16	0.812	15.9	5/16	0.312	7.9	3/8	0.375	9.5	1/8	0.125	3.2	9/16	0.562	14.3	2856-45009
MS35489-67	AN931-B5-9	13/16	0.812	15.9	5/16	0.312	7.9	7/16	0.437	11.1	3/16	0.187	4.7	9/16	0.562	14.3	2756-45009
MS35489-96	AN931-C5-9	13/16	0.812	25.4	5/16	0.312	7.9	1/2	0.5	12.7	1/4	0.25	6.4	9/16	0.562	14.3	2556-45009
MS35489-11	AN930-1	11/16	0.687	31.8	3/8	0.375	9.5	9/32	0.281	7.1	1/16	0.062	1.6	1/2	0.5	12.7	97-45009
	AN930-2	3/4	0.75	11.1	3/8	0.375	9.5	3/8	0.375	9.5	1/16	0.062	1.6	9/16	0.562	14.3	
	AN930-3	3/4	0.75	11.1	3/8	0.375	9.5	3/4	0.75	19.1	3/8	0.375	9.5	9/16	0.562	14.3	
MS35489-11	AN931-6-10	7/8	0.875	31.8	3/8	0.375	9.5	5/16	0.312	7.9	1/16	0.062	1.6	5/8	0.625	15.9	2281-45009
MS35489-40	AN931-A6-10	7/8	0.875	20.6	3/8	0.375	9.5	3/8	0.375	9.5	1/8	0.125	3.2	5/8	0.625	15.9	2858-45009

# ARMY-NAVY APPROVED AN931 GROMMETS

By "B" Dimension



MS35489 PART NO.	AN931 PART NO.	A			B			C			D			E			ESTCO Part No.
		Inch	Dec	MM	Inch	Dec	MM	Inch	Dec	MM	Inch	Dec	MM	Inch	Dec	MM	
MS35489-69	AN931-B6-10	3/8	0.375	9.5	5/8	0.625	15.9	7/8	0.875	22.2	3/16	0.187	4.7	7/16	0.437	11.1	2758-45009
MS35489-98	AN931-C6-10	3/8	0.375	9.5	5/8	0.625	15.9	7/8	0.875	22.2	1/4	0.25	6.4	1/2	0.5	12.7	2558-45009
MS35489-13	AN931-7-11	7/16	0.437	11.1	11/16	0.687	17.4	15/16	0.937	23.8	1/16	0.062	1.6	5/16	0.312	7.9	2282-45009
MS35489-42	AN931-A7-11	7/16	0.437	11.1	11/16	0.687	17.4	15/16	0.937	23.8	1/8	0.125	3.2	3/8	0.375	9.5	2860-45009
MS35489-71	AN931-B7-11	7/16	0.437	11.1	11/16	0.687	17.4	15/16	0.937	23.8	3/16	0.187	4.7	7/16	0.437	11.1	2760-45009
MS35489-100	AN931-C7-11	7/16	0.437	11.1	11/16	0.687	17.4	15/16	0.937	23.8	1/4	0.25	6.4	1/2	0.5	12.7	2560-45009
MS35489-150	AN930-4	1/2	0.5	12.7	3/4	0.75	19.1	1	1	25.4	3/32	0.093	2.4	9/32	0.281	7.1	3761-45009
MS35489-7	AN931-4-12	1/4	0.25	6.4	3/4	0.75	19.1	1	1	25.4	1/16	0.062	1.6	1/4	0.25	6.4	3762-45009
MS35489-36	AN931-A4-12	1/4	0.25	6.4	3/4	0.75	19.1	1	1	25.4	1/8	0.125	3.2	5/16	0.312	7.9	3762-45009
MS35489-65	AN931-B4-12	1/4	0.25	6.4	3/4	0.75	19.1	1	1	25.4	3/16	0.187	4.7	3/8	0.375	9.5	2280-45009
MS35489-94	AN931-C4-12	1/4	0.25	6.4	3/4	0.75	19.1	1	1	25.4	1/4	0.25	6.4	7/16	0.437	11.1	2857-45009
MS35489-10	AN931-5-12	5/16	0.312	7.9	3/4	0.75	19.1	1	1	25.4	1/16	0.062	1.6	5/16	0.312	7.9	2757-45009
MS35489-39	AN931A-5-12	5/16	0.312	7.9	3/4	0.75	19.1	1	1	25.4	1/8	0.125	3.2	3/8	0.375	9.5	2557-45009
MS35489-68	AN931-B5-12	5/16	0.312	7.9	3/4	0.75	19.1	1	1	25.4	3/16	0.187	4.7	7/16	0.437	11.1	3834-45009
MS35489-97	AN931-C5-12	5/16	0.312	7.9	3/4	0.75	19.1	1	1	25.4	1/4	0.25	6.4	1/2	0.5	12.7	3835-45009
MS35489-118	AN931-5-13	5/16	0.312	7.9	13/16	0.812	20.6	1 1/16	1.062	27	1/16	0.062	1.6	5/16	0.312	7.9	3836-45009
MS35489-122	AN931-A5-13	5/16	0.312	7.9	13/16	0.812	20.6	1 1/16	1.062	27	1/8	0.125	3.2	3/8	0.375	9.5	3837-45009
	AN931-B5-13	5/16	0.312	7.9	13/16	0.812	20.6	1 1/16	1.062	27	3/16	0.187	4.7	7/16	0.437	11.1	2283-45009
	AN931-C5-13	5/16	0.312	7.9	13/16	0.812	20.6	1 1/16	1.062	27	1/4	0.25	6.4	1/2	0.5	12.7	2861-45009
MS35489-14	AN931-8-13	1/2	0.5	12.7	13/16	0.812	20.6	1 1/16	1.062	27	1/16	0.062	1.6	5/16	0.312	7.9	2761-45009
MS35489-43	AN931-A8-13	1/2	0.5	12.7	13/16	0.812	20.6	1 1/16	1.062	27	1/8	0.125	3.2	3/8	0.375	9.5	2774-45009
MS35489-72	AN931-B8-13	1/2	0.5	12.7	13/16	0.812	20.6	1 1/16	1.062	27	3/16	0.187	4.7	7/16	0.437	11.1	2295-45009
MS35489-83	AN931-C8-13	1/2	0.5	12.7	13/16	0.812	20.6	1 1/16	1.062	27	1/4	0.25	6.4	1/2	0.5	12.7	2561-45009
MS35489-16	AN931-9-13	9/16	0.562	14.3	13/16	0.812	20.6	1 1/16	1.062	27	1/16	0.062	1.6	5/16	0.312	7.9	2763-45009
MS35489-101	AN931-A9-13	9/16	0.562	14.3	13/16	0.812	20.6	1 1/16	1.062	27	1/8	0.125	3.2	3/8	0.375	9.5	2563-45009
MS35489-74	AN931-B9-13	9/16	0.562	14.3	13/16	0.812	20.6	1 1/16	1.062	27	3/16	0.187	4.7	7/16	0.437	11.1	2285-45009
MS35489-103	AN931-C9-13	9/16	0.562	14.3	13/16	0.812	20.6	1 1/16	1.062	27	1/4	0.25	6.4	1/2	0.5	12.7	2864-45009
MS35489-17	AN931-10-14	5/8	0.625	15.9	7/8	0.875	22.2	1 1/8	1.125	28.6	1/16	0.062	1.6	5/16	0.312	7.9	2764-45009
MS35489-46	AN931-A10-14	5/8	0.625	15.9	7/8	0.875	22.2	1 1/8	1.125	28.6	1/8	0.125	3.2	3/8	0.375	9.5	2564-45009
MS35489-75	AN931-B10-14	5/8	0.625	15.9	7/8	0.875	22.2	1 1/8	1.125	28.6	3/16	0.187	4.7	7/16	0.437	11.1	2564-45009
MS35489-104	AN931-C10-14	5/8	0.625	15.9	7/8	0.875	22.2	1 1/8	1.125	28.6	1/4	0.25	6.4	1/2	0.5	12.7	2297-45009
MS35489-3	AN931-2-16	1/8	0.125	3.2	1	1	25.4	1 1/4	1.25	31.8	1/16	0.062	1.6	1/4	0.25	6.4	2851-45009
MS35489-32	AN931-A2-16	1/8	0.125	3.2	1	1	25.4	1 1/4	1.25	31.8	1/8	0.125	3.2	5/16	0.312	7.9	2751-45009
MS35489-61	AN931-B2-16	1/8	0.125	3.2	1	1	25.4	1 1/4	1.25	31.8	3/16	0.187	4.7	3/8	0.375	9.5	2551-45009
MS35489-90	AN931-C2-16	1/8	0.125	3.2	1	1	25.4	1 1/4	1.25	31.8	1/4	0.25	6.4	7/16	0.437	11.1	2298-45009
MS35489-8	AN931-4-16	1/4	0.25	6.4	1	1	25.4	1 1/4	1.25	31.8	1/16	0.062	1.6	1/4	0.25	6.4	2855-45009
MS35489-37	AN931-A4-16	1/4	0.25	6.4	1	1	25.4	1 1/4	1.25	31.8	1/8	0.125	3.2	5/16	0.312	7.9	2755-45009
MS35489-66	AN931-B4-16	1/4	0.25	6.4	1	1	25.4	1 1/4	1.25	31.8	3/16	0.187	4.7	3/8	0.375	9.5	2555-45009
MS35489-95	AN931-C4-16	1/4	0.25	6.4	1	1	25.4	1 1/4	1.25	31.8	1/4	0.25	6.4	7/16	0.437	11.1	

- AN931 TO PROCUREMENT SPECIFICATION AN-G-21
- ARMY-NAVY STANDARD GROMMETS
- RUBBER, HOT-OIL & COOLANT RESISTANT MATERIAL SPECIFICATION: MIL-G-3036
- Purchasing grommets under this specification should include a waiver of the samples test and affidavits required by revision MIL-G-3036. Our packing slip contains a certification of material with each shipment. In the event the very strict testing requirements of revision MIL-G-3036 are required, there will be an extra charge for laboratory expenses.

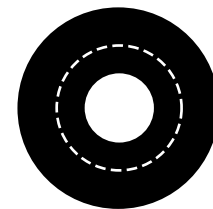
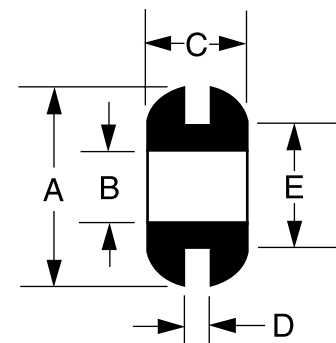



# ARMY-NAVY APPROVED AN931 GROMMETS

By "B" Dimension

- AN931 TO PROCUREMENT SPECIFICATION AN-G-21
- ARMY-NAVY STANDARD GROMMETS
- RUBBER, HOT-OIL & COOLANT RESISTANT MATERIAL SPECIFICATION: MIL-G-3036
- Purchasing grommets under this specification should include a waiver of the samples test and affidavits required by revision MIL-G-3036. Our packing slip contains a certification of material with each shipment. In the event the very strict testing requirements of revision MIL-G-3036 are required, there will be an extra charge for laboratory expenses.

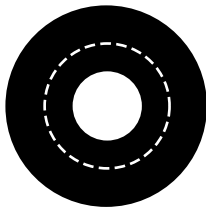
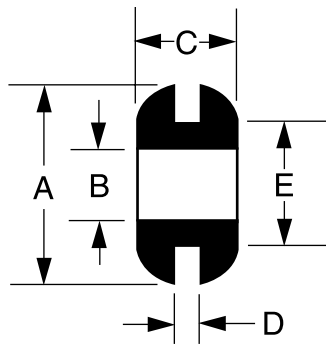

MS35489 PART NO.	AN931 PART NO.	A			B			C			D			E			ESTCO Part No.
		Inch	Dec	MM	Inch	Dec	MM	Inch	Dec	MM	Inch	Dec	MM	Inch	Dec	MM	
MS35489-12	AN931-6-16	3/8	0.375	9.5	1	1	25.4	1 1/4	1.25	31.8	1/16	0.062	1.6	1/4	0.25	6.4	2299-45009
MS35489-41	AN931-A6-16	3/8	0.375	9.5	1	1	25.4	1 1/4	1.25	31.8	1/8	0.125	3.2	5/16	0.312	7.9	2859-45009
	AN931-B6-16	3/8	0.375	9.5	1	1	25.4	1 1/4	1.25	31.8	3/16	0.187	4.7	3/8	0.375	9.5	
MS35489-99	AN931-C6-16	3/8	0.375	9.5	1	1	25.4	1 1/4	1.25	31.8	1/4	0.25	6.4	7/16	0.437	11.1	2273-45009
MS35489-19	AN931-11-16	11/16	0.687	17.4	1	1	25.4	1 5/16	1.312	33.3	1/16	0.062	1.6	3/8	0.375	9.5	
MS35489-48	AN931-A11-16	11/16	0.687	17.4	1	1	25.4	1 5/16	1.312	33.3	1/8	0.125	3.2	7/16	0.437	11.1	2866-45009
MS35489-77	AN931-B11-16	11/16	0.687	17.4	1	1	25.4	1 5/16	1.312	33.3	3/16	0.187	4.7	1/2	0.5	12.7	2766-45009
MS35489-106	AN931-C11-16	11/16	0.687	17.4	1	1	25.4	1 5/16	1.312	33.3	1/4	0.25	6.4	9/16	0.563	14.3	2566-45009
MS35489-20	AN931-12-17	3/4	0.75	19.1	1 1/16	1.062	27	1 3/8	1.375	34.9	1/16	0.062	1.6	3/8	0.375	9.5	804-45009
MS35489-49	AN931-A12-17	3/4	0.75	19.1	1 1/16	1.062	27	1 3/8	1.375	34.9	1/8	0.125	3.2	7/16	0.437	11.1	2867-45009
MS35489-78	AN931-B12-17	3/4	0.75	19.1	1 1/16	1.062	27	1 3/8	1.375	34.9	3/16	0.187	4.7	1/2	0.5	12.7	2767-45009
MS35489-107	AN931-C12-17	3/4	0.75	19.1	1 1/16	1.062	27	1 3/8	1.375	34.9	1/4	0.25	6.4	9/16	0.563	14.3	2567-45009
MS35489-15	AN930-21	7/8	0.875	22.2	1 1/4	1.25	31.8	1 9/16	1.562	39.7	3/16	0.187	4.7	3/4	0.75	19.1	2284-45009
	AN931-8-20	1/2	0.5	12.7	1 1/4	1.25	31.8	1 1/2	1.5	38.1	1/16	0.062	1.6	1/4	0.25	6.4	
MS35489-44	AN931-A8-20	1/2	0.5	12.7	1 1/4	1.25	31.8	1 1/2	1.5	38.1	1/8	0.125	3.2	5/16	0.312	7.9	2862-45009
MS35489-73	AN931-B8-20	1/2	0.5	12.7	1 1/4	1.25	31.8	1 1/2	1.5	38.1	3/16	0.187	4.7	3/8	0.375	9.5	2762-45009
MS35489-102	AN931-C8-20	1/2	0.5	12.7	1 1/4	1.25	31.8	1 1/2	1.5	38.1	1/4	0.25	6.4	7/16	0.437	11.1	2296-45009
MS35489-18	AN931-10-20	5/8	0.625	15.9	1 1/4	1.25	31.8	1 1/2	1.5	38.1	1/16	0.062	1.6	1/4	0.25	6.4	
MS35489-47	AN931-A10-20	5/8	0.625	15.9	1 1/4	1.25	31.8	1 1/2	1.5	38.1	1/8	0.125	3.2	5/16	0.312	7.9	2765-45009
MS35489-76	AN931-B10-20	5/8	0.625	15.9	1 1/4	1.25	31.8	1 1/2	1.5	38.1	3/16	0.187	4.7	3/8	0.375	9.5	
MS35489-135	AN931-C10-20	5/8	0.625	15.9	1 1/4	1.25	31.8	1 1/2	1.5	38.1	1/4	0.25	6.4	7/16	0.437	11.1	2274-45009
	AN931-12-20	3/4	0.75	19.1	1 1/4	1.25	31.8	1 5/8	1.625	41.3	1/16	0.062	1.6	1/4	0.25	6.4	
MS35489-123	AN931-A12-20	3/4	0.75	19.1	1 1/4	1.25	31.8	1 5/8	1.625	41.3	1/8	0.125	3.2	5/16	0.312	7.9	2868-45009
MS35489-126	AN931-B12-20	3/4	0.75	19.1	1 1/4	1.25	31.8	1 5/8	1.625	41.3	3/16	0.187	4.7	3/8	0.375	9.5	2768-45009
MS35489-131	AN931-C12-20	3/4	0.75	19.1	1 1/4	1.25	31.8	1 5/8	1.625	41.3	1/4	0.25	6.4	7/16	0.437	11.1	2568-45009
MS35489-22	AN931-14-20	7/8	0.875	22.2	1 1/4	1.25	31.8	1 5/8	1.625	41.3	1/16	0.062	1.6	7/16	0.437	11.1	2276-45009
MS35489-51	AN931-A14-20	7/8	0.875	22.2	1 1/4	1.25	31.8	1 5/8	1.625	41.3	1/8	0.125	3.2	1/2	0.5	12.7	2870-45009
MS35489-80	AN931-B14-20	7/8	0.875	22.2	1 1/4	1.25	31.8	1 5/8	1.625	41.3	3/16	0.187	4.7	9/16	0.563	14.3	2770-45009
MS35489-109	AN931-C14-20	7/8	0.875	22.2	1 1/4	1.25	31.8	1 5/8	1.625	41.3	1/4	0.25	6.4	5/8	0.625	15.9	2570-45009

# ARMY-NAVY APPROVED AN931 GROMMETS

By "B" Dimension



MS35489 PART NO.	AN931 PART NO.	A			B			C			D			E			ESTCO Part No.
		Inch	Dec	MM	Inch	Dec	MM	Inch	Dec	MM	Inch	Dec	MM	Inch	Dec	MM	
MS35489-23	AN931-16-22	1	1	25.4	1 3/8	1.375	34.9	1 3/4	1.75	44.5	1/16	0.062	1.6	7/16	0.437	11.1	2277-45009
MS35489-52	AN931-A16-22	1	1	25.4	1 3/8	1.375	34.9	1 3/4	1.75	44.5	1/8	0.125	3.2	1/2	0.5	12.7	2872-45009
MS35489-81	AN931-B16-22	1	1	25.4	1 3/8	1.375	34.9	1 3/4	1.75	44.5	3/16	0.187	4.7	9/16	0.563	14.3	2772-45009
MS35489-110	AN931-C16-22	1	1	25.4	1 3/8	1.375	34.9	1 3/4	1.75	44.5	1/4	0.25	6.4	5/8	0.625	15.9	2572-45009
MS35489-21	AN931-12-23	3/4	0.75	19.1	1 7/16	1.437	36.5	1 13/16	1.812	46	1/16	0.062	1.6	3/8	0.375	9.5	2275-45009
MS35489-50	AN931-A12-23	3/4	0.75	19.1	1 7/16	1.437	36.5	1 13/16	1.812	46	1/8	0.125	3.2	7/16	0.437	11.1	2869-45009
	AN931-B12-23	3/4	0.75	19.1	1 7/16	1.437	36.5	1 13/16	1.812	46	3/16	0.187	4.7	1/2	0.5	12.7	
MS35489-168	AN931-C12-23	3/4	0.75	19.1	1 7/16	1.437	36.5	1 13/16	1.812	46	1/4	0.25	6.4	9/16	0.563	14.3	
MS35489-120	AN931-12-26	3/4	0.75	19.1	1 5/8	1.625	41.3	2	2	50.8	1/16	0.062	1.6	3/8	0.375	9.5	
MS35489-124	AN931-A12-26	3/4	0.75	19.1	1 5/8	1.625	41.3	2	2	50.8	1/8	0.125	3.2	7/16	0.437	11.1	
	AN931-B12-26	3/4	0.75	19.1	1 5/8	1.625	41.3	2	2	50.8	3/16	0.187	4.7	1/2	0.5	12.7	
	AN931-C12-26	3/4	0.75	19.1	1 5/8	1.625	41.3	2	2	50.8	1/4	0.25	6.4	9/16	0.563	14.3	
MS35489-121	AN931-14-26	7/8	0.875	22.2	1 5/8	1.625	41.3	2	2	50.8	1/16	0.062	1.6	7/16	0.437	11.1	2300-45009
MS35489-125	AN931-A14-26	7/8	0.875	22.2	1 5/8	1.625	41.3	2	2	50.8	1/8	0.125	3.2	1/2	0.5	12.7	2871-45009
	AN931-B14-26	7/8	0.875	22.2	1 5/8	1.625	41.3	2	2	50.8	3/16	0.187	4.7	9/16	0.563	14.3	
	AN931-C14-26	7/8	0.875	22.2	1 5/8	1.625	41.3	2	2	50.8	1/4	0.25	6.4	5/8	0.625	15.9	
MS35489-27	AN931-24-28	1 1/2	1.5	38.1	1 3/4	1.75	44.5	2 1/8	2.125	54	1/16	0.062	1.6	7/16	0.437	11.1	2278-45009
MS35489-56	AN931-A24-28	1 1/2	1.5	38.1	1 3/4	1.75	44.5	2 1/8	2.125	54	1/8	0.125	3.2	1/2	0.5	12.7	2875-45009
MS35489-85	AN931-B24-28	1 1/2	1.5	38.1	1 3/4	1.75	44.5	2 1/8	2.125	54	3/16	0.187	4.7	9/16	0.563	14.3	2775-45009
MS35489-114	AN931-C24-28	1 1/2	1.5	38.1	1 3/4	1.75	44.5	2 1/8	2.125	54	1/4	0.25	6.4	5/8	0.625	15.9	2575-45009
MS35489-24	AN931-16-30	1	1	25.4	1 7/8	1.875	47.6	2 1/4	2.25	57.2	1/16	0.062	1.6	7/16	0.437	11.1	2301-45009
MS35489-53	AN931-A16-30	1	1	25.4	1 7/8	1.875	47.6	2 1/4	2.25	57.2	1/8	0.125	3.2	1/2	0.5	12.7	2873-45009
MS35489-82	AN931-B16-30	1	1	25.4	1 7/8	1.875	47.6	2 1/4	2.25	57.2	3/16	0.187	4.7	9/16	0.563	14.3	
MS35489-111	AN931-C16-30	1	1	25.4	1 7/8	1.875	47.6	2 1/4	2.25	57.2	1/4	0.25	6.4	5/8	0.625	15.9	2573-45009
MS35489-25	AN931-20-38	1 1/4	1.25	31.8	2 3/8	2.375	60.3	2 3/4	2.75	69.9	1/16	0.062	1.6	7/16	0.437	11.1	2302-45009
MS35489-54	AN931-A20-38	1 1/4	1.25	31.8	2 3/8	2.375	60.3	2 3/4	2.75	69.9	1/8	0.125	3.2	7/16	0.437	11.1	2874-45009
MS35489-83	AN931-B20-38	1 1/4	1.25	31.8	2 3/8	2.375	60.3	2 3/4	2.75	69.9	3/16	0.187	4.7	9/16	0.563	14.3	2774-45009
MS35489-112	AN931-C20-38	1 1/4	1.25	31.8	2 3/8	2.375	60.3	2 3/4	2.75	69.9	1/4	0.25	6.4	5/8	0.625	15.9	2574-45009
MS35489-26	AN931-20-40	1 1/4	1.2	30.5	2 1/2	2.5	63.5	2 7/8	2.875	73	1/16	0.062	1.6	7/16	0.437	11.1	
MS35489-55	AN931-A20-40	1 1/4	1.25	31.8	2 1/2	2.5	63.5	2 7/8	2.875	73	1/8	0.125	3.2	7/16	0.437	11.1	
	AN931-B20-40	1 1/4	1.25	31.8	2 1/2	2.5	63.5	2 7/8	2.875	73	3/16	0.187	4.7	9/16	0.563	14.3	
	AN931-C20-40	1 1/4	1.25	31.8	2 1/2	2.5	63.5	2 7/8	2.875	73	1/4	0.25	6.4	5/8	0.625	15.9	
MS35489-28	AN931-24-44	1 1/2	1.5	38.1	2 3/4	2.75	69.9	3 1/4	3.25	82.6	1/16	0.062	1.6	7/16	0.437	11.1	3995-45009
MS35489-57	AN931-A24-44	1 1/2	1.5	38.1	2 3/4	2.75	69.9	3 1/4	3.25	82.6	1/8	0.125	3.2	1/2	0.5	12.7	3996-45009
	AN931-B24-44	1 1/2	1.5	38.1	2 3/4	2.75	69.9	3 1/4	3.25	82.6	3/16	0.187	4.7	9/16	0.563	14.3	
	AN931-C24-44	1 1/2	1.5	38.1	2 3/4	2.75	69.9	3 1/4	3.25	82.6	1/4	0.25	6.4	5/8	0.625	15.9	
	AN931-28-52	1 3/4	1.75	44.5	3 1/4	3.25	82.6	3 3/4	3.75	95.3	1/16	0.062	1.6	1/2	0.5	12.7	
	AN931-A28-52	1 3/4	1.75	44.5	3 1/4	3.25	82.6	3 3/4	3.75	95.3	1/8	0.125	3.2	9/16	0.563	14.3	
	AN931-B28-52	1 3/4	1.75	44.5	3 1/4	3.25	82.6	3 3/4	3.75	95.3	3/16	0.187	4.7	5/8	0.625	15.9	

- AN931 TO PROCUREMENT SPECIFICATION AN-G-21
- ARMY-NAVY STANDARD GROMMETS
- RUBBER, HOT-OIL & COOLANT RESISTANT MATERIAL SPECIFICATION: MIL-G-3036
- Purchasing grommets under this specification should include a waiver of the samples test and affidavits required by revision MIL-G-3036. Our packing slip contains a certification of material with each shipment. In the event the very strict testing requirements of revision MIL-G-3036 are required, there will be an extra charge for laboratory expenses.

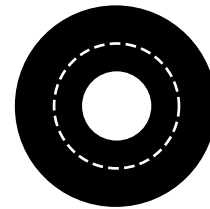
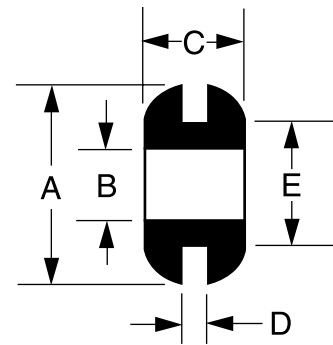



## ARMY-NAVY APPROVED AN931 GROMMETS

By "B" Dimension

- AN931 TO PROCUREMENT SPECIFICATION AN-G-21
- ARMY-NAVY STANDARD GROMMETS
- RUBBER, HOT-OIL & COOLANT RESISTANT MATERIAL SPECIFICATION: MIL-G-3036
- Purchasing grommets under this specification should include a waiver of the samples test and affidavits required by revision MIL-G-3036. Our packing slip contains a certification of material with each shipment. In the event the very strict testing requirements of revision MIL-G-3036 are required, there will be an extra charge for laboratory expenses.

PART NO.	A			B			C			D			E		
	Inch	Dec	MM	Inch	Dec	MM	Inch	Dec	MM	Inch	Dec	MM	Inch	Dec	MM
AN931-C28-52	1 3/4	1.75	44.5	3 1/4	3.25	82.6	3 3/4	3.75	95.3	1/4	0.25	6.4	11/16	0.687	17.4
AN931-32-56	2	2	50.8	3 1/2	3.5	88.9	4	4	101.6	1/16	0.062	1.6	1/2	0.5	12.7
AN931-A32-56	2	2	50.8	3 1/2	3.5	88.9	4	4	101.6	1/8	0.125	3.2	9/16	0.563	14.3
AN931-B32-56	2	2	50.8	3 1/2	3.5	88.9	4	4	101.6	3/16	0.187	4.7	5/8	0.625	15.9
AN931-C32-56	2	2	50.8	3 1/2	3.5	88.9	4	4	101.6	1/4	0.25	6.4	11/16	0.687	17.4

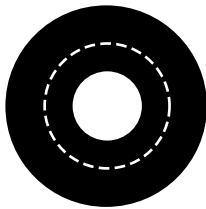
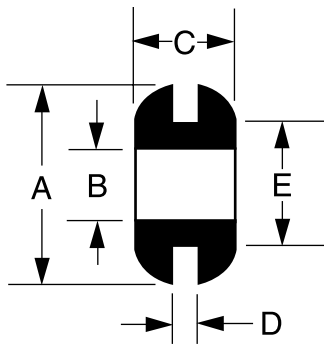

ISO 9001 Certified  
CERTIFICATE # 08-511



# RUBBER FEET



**Cable Straps**  
3-2



**Collapsible Tilt Stands**  
3-3



**Crutch Tips**  
3-4

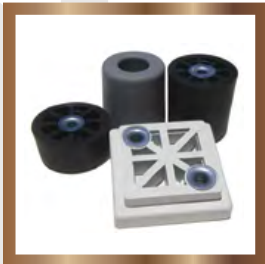

**Misc. Thermoplastic Rubber Feet**  
3-5



**Rectangular Thermoplastic Rubber Feet**  
3-6



**Round Polyethylene (PE) Feet**  
3-7



**Round Thermoplastic Rubber Feet**  
3-8



**Square Thermoplastic Rubber Feet**  
3-9



## CABLE STRAPS

- Designed as a quick and efficient method for attaching small wire bundles, cable, tubing, etc. to sheet metal. Simply snap the ring end into the specified diameter hole, position wiring, fold strap over and lock in place.
- **Stock Material:** Ethylene-Vinyl Acetate Copolymer
- **Stock Colors:** Medium Gray
- **RoHS:** Compliant

PART NUMBER	LOOP DIAMETER A	MAXIMUM MATERIAL THICKNESS B	LENGTH BETWEEN CENTERS C	HEAD HEIGHT D	LOCK RING HEIGHT E
TPR-4-4-1	1/4	.062	1-1/4	.344	.105
TPR-4-7-1	3/8	.062	1-3/4	.344	.105
TPR-4-10-1	9/16	.062	2-3/8	.344	.105
TPR-4-10-2	9/16	.093	2-3/8	.375	.136

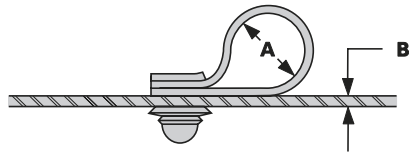

4-7-1 Actual Size

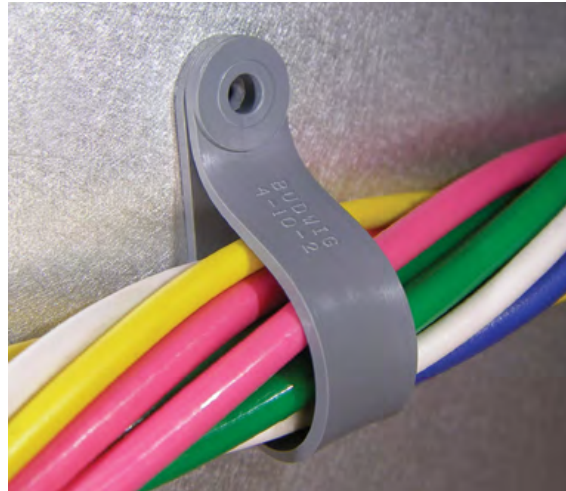
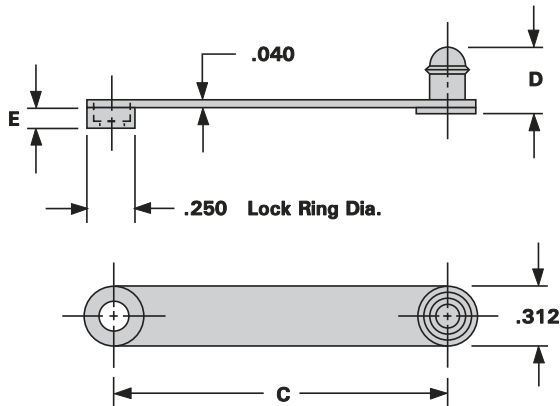

# COLLAPSIBLE TILT STANDS

PART NUMBER	FEET MOUNTING CENTERS A	Height A
TPR-CTS 3.6	3	2
TPR-CTS 5-1/2	5-1/2	1-1/2
TPR-CTS 5-1/2	5-1/2	2-1/2
TPR-CTS 7	7	2
TPR-CTS 7	7	2-1/2
TPR-CTS 7	7	3
TPR-CTS 10	10	2-1/2
TPR-CTS 10	10	3
TPR-CTS 11-1/4	11-1/4	3
TPR-CTS 12	12	2-1/2
TPR-CTS 15-1/2	15-1/2	2-1/2



- Set consists of four low-profile molded feet and steel stand snaps into the upright position, and when not in use, the tilt stand folds flat against cabinet, storage or stacking. Skid resistant rear feet help keep instrument in place without marking.
  - Collapsible Tilt Stand includes:
    - (2) Front feet, black nylon (F-034-N-B, R & L Foot)
    - (2) Rear feet, black thermoplastic rubber (MF6-1T)
    - (1) Tilt stand, steel with black epoxy finish and two Neoprene rubber bumpers.
- RoHS: Compliant**

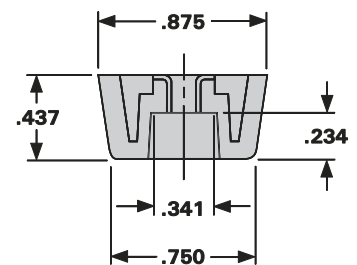
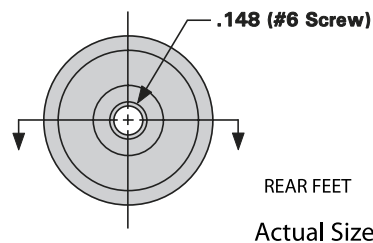
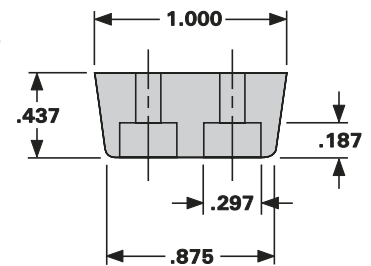
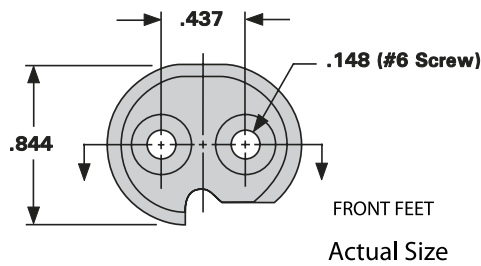
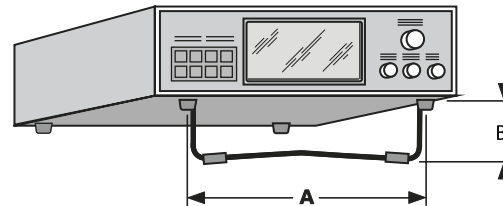

## CRUTCH TIPS - TYPE CT



PART NO.	A	B	C	D	E
CT-15	1	3/4	27/32	3/8	17/32
CT-16	1-3/16	7/8	29/32	1/2	5/8
CT-17	1-9/32	15/16	1	19/32	23/32
CT-18	1-3/8	1-1/8	1	23/32	7/8
CT-19	1-11/32	1-1/4	1-1/16	13/16	31/32
CT-20	1-3/8	1-3/8	1	15/16	1-3/32

- Highly Wet-Slip Resistant Tread Greatly Reduces Slipping Especially On Wet Surfaces.
- Tips are available in six sizes to fit cane shafts that are 3/8" to 15/16" diameter.

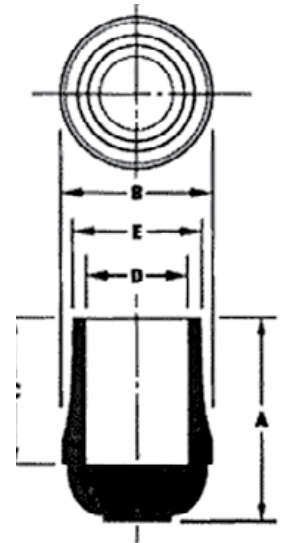

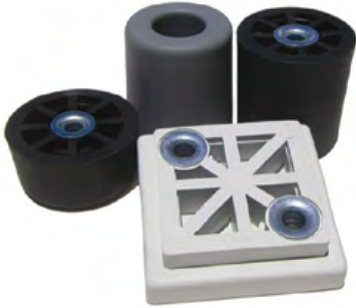

## MISCELLANEOUS THERMOPLASTIC RUBBER FEET

- Molded from "Thermoplastic Rubber" Cabinet Feet provide good traction, excellent shock absorbing qualities and unlike natural rubber they have good non-marking qualities and outstanding resistance to stress cracking. A Trivalent Chromate plated steel Support Bushing absorbs the total fastener load allowing the foot to be mounted using a variety of screws or rivets without causing distortion to the foot itself. Excellent resistance to ozone, aging and most chemicals. Available in any color on special order.

PART NUMBER	DWG No.	Height A	Dia. B	Dia. C	Recess Dia. D	Recess Depth E	Outer Wall F	Insert I.D. & Screw Size	
								T.H (Truss Head) R.H (Round Head) G	No S/B Through Hole I.D. G
TPR-F-060-	1	1.375	1.375	1.303	.594	.890	.150	.211 #10 Truss Head	.252
TPR-F-061-	4	.600	N/A	N/A	.413	.288	N/A	.215 #10 Truss Head	.260
TPR-F-063-	2	1.500	1.375	1.297	.594	1.015	.150	.211 #10 Truss Head	.252
TPR-F-066-	N/A	.700	.750	.710	.338	.405	.082	.178 #8 Truss Head	.205
TPR-F-067-	3	.648	1.621	1.553	.518	.336	.130	.202 #10 Truss Head	.201
TPR-F-068-	N/A	1.135	1.621	1.503	.518	.823	.130	.178 #8 Truss Head	.201

- Stock Material:** Monsanto Santoprene (87 shore A)
- Stock Colors:** Black or Medium Gray
- RoHS:** Parts are RoHS Compliant.

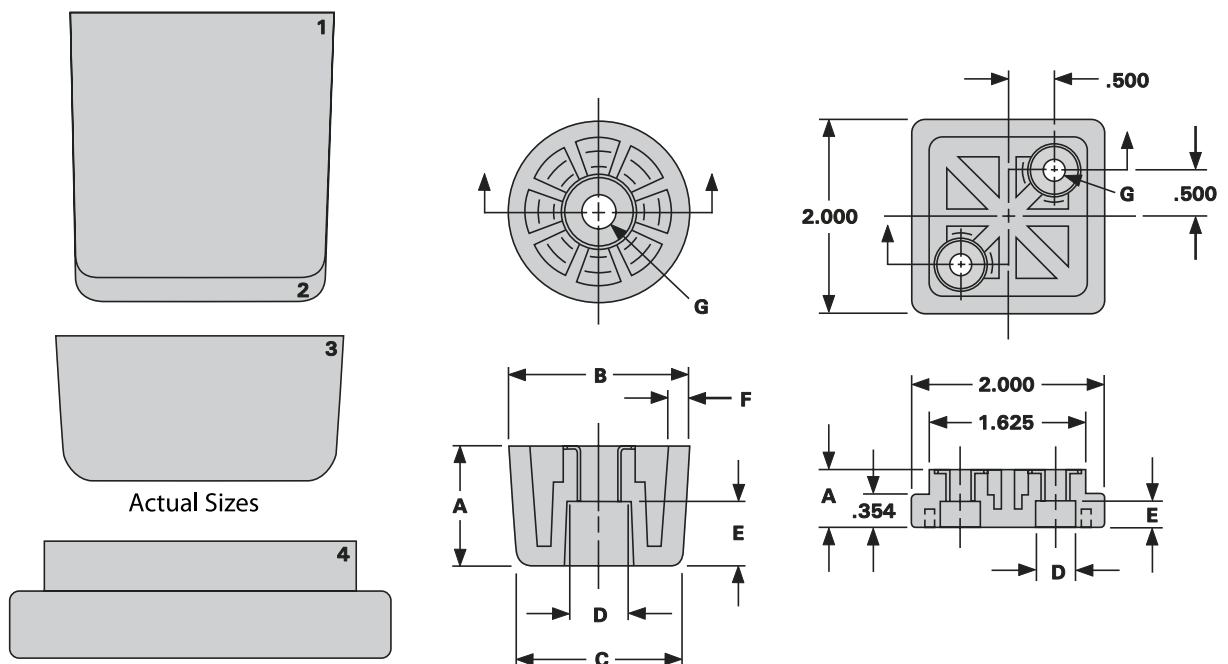

# RECTANGULAR THERMOPLASTIC RUBBER FEET WITH STEEL SUPPORT BUSHING



PART NUMBER	KEY NO.	Height A	Length B	Length C	Width D	Recess Dia. E	Recess Depth F	Outer Wall G	Insert I.D. & Screw Size H	Lug Dia. I	*Weight Capacity (per foot)
TPR-RF6T	1	.344	1.768	1.672	.885	.333	.142	.095	.148 #6 Truss Head	.875	TBD
TPR-RF6-1	2	.390	2.022	1.912	1.005	.333	.187	.125	.148 #6 Truss Head	1.000	TBD
TPR-RF8T	3	.465	2.380	2.250	1.187	.409	.176	.142	.178 #8 Truss Head	1.187	TBD
TPR-RF10T	4	.528	2.777	2.629	1.375	.472	.202	.172	.215 #10 Truss Head	1.375	TBD
TPR-RF10-1	5	.590	3.000	2.834	1.510	.472	.280	.190	.215 #10 Truss Head	1.500	TBD

- Molded from "Thermoplastic Rubber" Cabinet Feet provide good traction, excellent shock absorbing qualities and unlike natural rubber they have good non-marking qualities and outstanding resistance to stress cracking. A Trivalent Chromate plated steel Support Bushing absorbs the total fastener load allowing the foot to be mounted using a variety of screws or rivets without causing distortion to the foot itself. Excellent resistance to ozone, aging and most chemicals. Available in any color on special order.

- Stock Material:** Monsanto Santoprene (87 shore A)
- Stock Colors:** Black or Medium Gray
- RoHS:** Parts are RoHS Compliant.

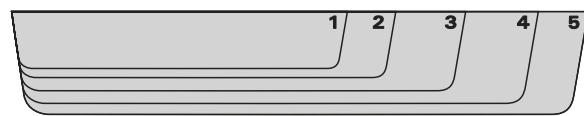
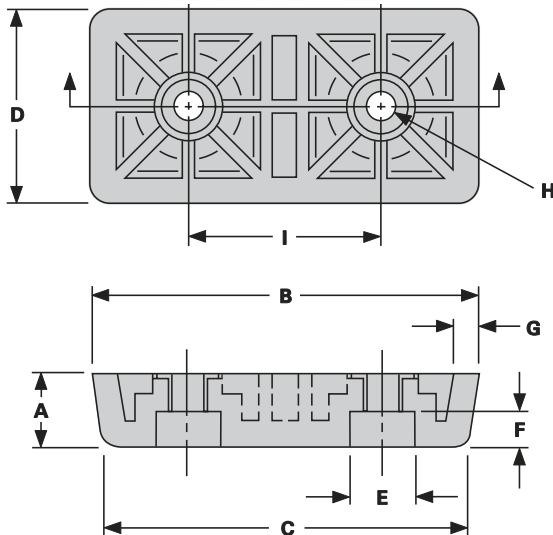

Actual Sizes



## ROUND POLYETHYLENE RUBBER FEET (PE)

- Molded from “Thermoplastic Rubber” Cabinet Feet provide good traction, excellent shock absorbing qualities and unlike natural rubber they have good non-marking qualities and outstanding resistance to stress cracking. A Trivalent Chromate plated steel Support Bushing absorbs the total fastener load allowing the foot to be mounted using a variety of screws or rivets without causing distortion to the foot itself. Excellent resistance to ozone, aging and most chemicals. Available in any color on special order.

PART NUMBER	DWG No.	Height A	Dia. B	Dia. C	Recess Dia. D	Recess Depth E	Outer Wall F	Insert I.D. & Screw Size T.H (Truss Head) R.H. (Round Head) G	No S/B Through Hole I.D. G
TPR-F-069-	3	1.621	1.621	1.451	.518	1.390	.130	N/A	.201
TPR-F-070-	N/A	2.255	1.668	1.500	.541	1.880	.130	N/A	.267
TPR-F-071-	4	2.000	1.625	1.485	.478	.823	.150	N/A	.192
TPR-F-072-	5	2.000	1.625	1.485	.478	1.250	.130	N/A	.192
TPR-F-073-	N/A	.980	1.250	1.160	.391	.500	.093	N/A	.194
TPR-F-074-	2	1.00	1.100	1.000	.510	.705	.110	#10 & .25 Truss / Round Head	.258
TPR-F-075-	N/A	.419	.625	.585	.345	.250	N/A	#8 Truss / Round Head	.200

- Stock Material:** Monsanto Santoprene (87 shore A)
- Stock Colors:** Black or Medium Gray
- RoHS:** Parts are RoHS Compliant.

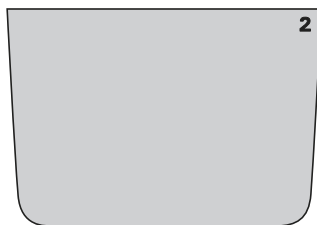

Actual Sizes

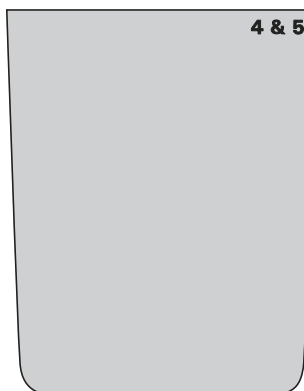
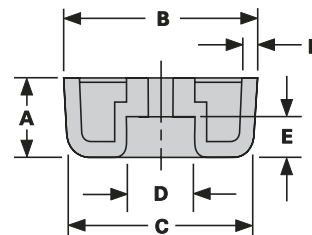
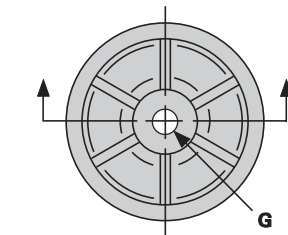
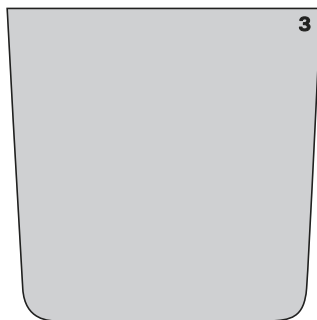

# ROUND THERMOPLASTIC RUBBER FEET WITH STEEL SUPPORT BUSHING



PART NUMBER	KEY NO.	Height A	Dia. B	Dia. C	Recess Dia. D	Recess Depth E	Outer Wall F	Insert I.D. & Screw Size T.H (Truss Head)	No S/B Through Hole I.D. G
SF6T-	1	.250	.687	.652	.336	.160	.076	.155 #6 T.H.	.172
SF8T-	2	.312	.875	.831	.399	.187	.096	.186 #8 T.H.	.204
SF8-1T-	2a	.375	.875	.812	.368	.250	.093	.186 #8 R.H.	.204
SF10T-	3	.437	1.062	1.000	.468	.229	.115	.201 #10 T.H.	.236
SF10-1T-	4	.500	1.312	1.242	.528	.184	.144	.215 #10 T.H.	.261
SF10-2T-	5	.562	1.625	1.547	.524	.250	.179	.215 #10 T.H.	.261
MF4T-	6	.312	.625	.537	.312	.127	.065	.108 #4 T.H.	.135
MF6T-	7	.375	.750	.644	.334	.177	.090	.148 #6 T.H.	.173
MF6-1T-	8	.437	.875	.753	.322	.225	.114	.148 #6 T.H.	.173
MF8T-	9	.531	1.062	.997	.408	.230	.125	.178 #8 T.H.	.210
MF10T-	10a	.625	1.250	1.174	.475	.328	.140	.215 #10 T.H.	.261
MF10-2T-	10b	.750	1.500	1.140	.475	.460	.170	.215 #10 T.H.	.261
TF4T-	11	.370	.553	.449	.207	.187	.062	.108 #4 R.H.	.136
TF6T-	12	.437	.750	.628	.272	.237	.085	.148 #6 R.H.	.171
TF8T-	13	.625	.932	.844	.359	.327	.110	.178 #8 R.H.	.208
TF10T-	14	.875	1.125	1.035	.525	.392	.125	.211 #10 T.H.	.251
TF10-1T-	15	1.125	1.250	1.132	.550	.636	.138	.211 #10 T.H.	.251
L6-	16	.703	1.010	.760	N/A	N/A	.078	.150 #6 R.H.	N/A

- Molded from "Thermoplastic Rubber" Cabinet Feet provide good traction, excellent shock absorbing qualities and unlike natural rubber they have good non-marking qualities and outstanding resistance to stress cracking. A Trivalent Chromate plated steel Support Bushing absorbs the total fastener load allowing the foot to be mounted using a variety of screws or rivets without causing distortion to the foot itself. Excellent resistance to ozone, aging and most chemicals. Available in any color on special order.

- Stock Material:** Monsanto Santoprene (87 shore A)
- Stock Colors:** Black or Medium Gray
- RoHS:** Parts are RoHS Compliant.

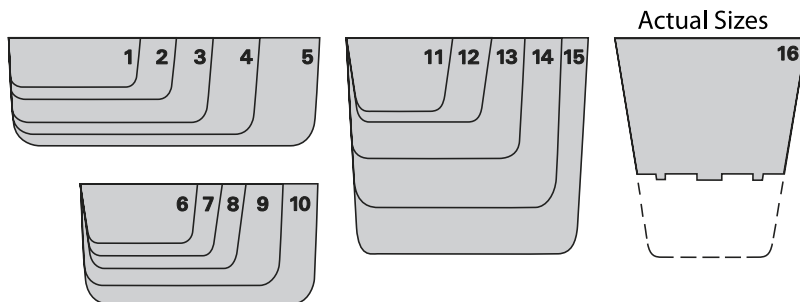
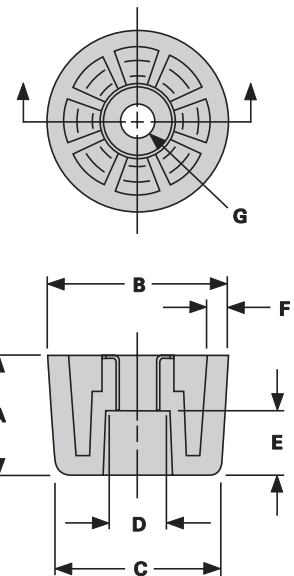





## SQUARE THERMOPLASTIC RUBBER FEET WITH STEEL SUPPORT BUSHING

- Molded from "Thermoplastic Rubber" Cabinet Feet provide good traction, excellent shock absorbing qualities and unlike natural rubber they have good non-marking qualities and outstanding resistance to stress cracking. A Trivalent Chromate plated steel Support Bushing absorbs the total fastener load allowing the foot to be mounted using a variety of screws or rivets without causing distortion to the foot itself. Excellent resistance to ozone, aging and most chemicals. Available in any color on special order.

- Stock Material:** Monsanto Santoprene (87 shore A)
- Stock Colors:** Black or Medium Gray
- RoHS:** Parts are RoHS Compliant.

PART NUMBER	KEY NO.	Height A	Width B & D	Width C	Recess Dia. E	Recess Depth F	Outer Wall G	Insert I.D. & Screw Size H	Lug Dia. I	*Weight Capacity (per foot)
TPR-SQF6T	1	.344	.890	.794	.333	.142	.095	.148 #6 Truss Head	.150	TBD
TPR-SQF6-1	2	.390	1.000	.890	.333	.187	.125	.148 #6 Truss Head	.150	TBD
TPR-SQF8T	3	.460	1.187	1.059	.409	.168	.145	.178 #8 Truss Head	.180	TBD
TPR-SQF10T	4	.522	1.375	1.229	.472	.202	.172	.215 #10 Truss Head	.210	TBD
TPR-SQF10-1	5	.590	1.500	1.336	.472	.275	.190	.215 #10 Truss Head	.210	TBD

PART NUMBER	MOUNTING HOLES		
	±.008 I	±.005 J	+ .004 - .000 K
TPR-SQF6T	.328	.656	.154 (#23 Drill)
TPR-SQF6-1	.390	.781	.154 (#23 Drill)
TPR-SQF8T	.453	.906	.185 (#13 Drill)
TPR-SQF10T	.531	1.062	.219 (7/32 Drill)
TPR-SQF10-1	.593	1.187	.219 (7/32 Drill)

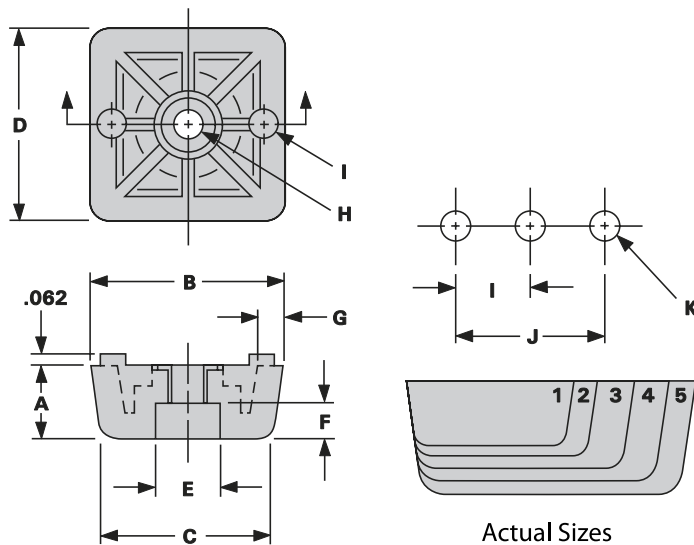

# SEAL, PLUG & FLASH MASTER

## SEAL AND PLUG



**Seal In / Seal Out Washers**  
4-3 - 4-4



**Plug Master-Fastening, Sealing, Cushioning System**  
4-5

## FLASH MASTER



**Standard Flash Master**  
4-6



**Universal Flash Master**  
4-7

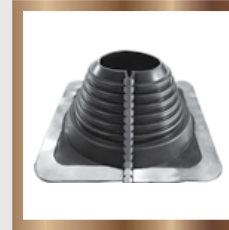

**Multi-Flash Flash Master**  
4-8

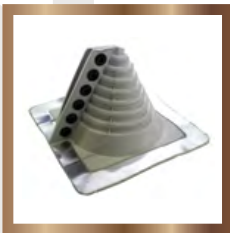

**Standard Retrofit Flash Master**  
4-9



**Universal Retrofit Flash Master**  
4-10

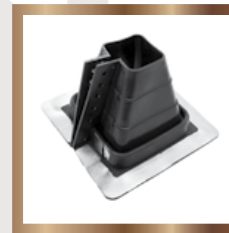

**Square Vent Flash Master**  
4-11

# SEAL, PLUG & FLASH MASTER

## FLASH MASTER CONTINUED



**Residential  
Flash Master**  
4-12

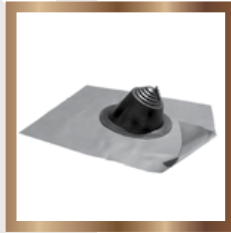

**Res-Lead  
Flash Master**  
4-13



**Master-Cap  
Flash Master**  
4-14



**Solar-Flash  
Flash Master**  
4-15



**Mini Standard  
Flash Master**  
4-15



**Multi-Port  
Flash Master**  
4-16



**NEW 35 YEAR  
Flash Master**  
4-17



# SEAL MASTER

“Washers are More than just Washers”

- Quality elastomeric compounding to meet specifications for elasticity, memory, temperature extremes, chemical-, ozone-, and sunlight-resistance.
- Conical design directs flow of facing materials to form a seal conforming to both fastener and sealing surface.
- Full-face design cushions fragile surfaces and minimizes vibration.
- Inside diameter sizes for #4 diameter screw to 1 1/2" diameter bolts and corresponding metric range.
- Outside diameter sizes from 1/4" to 3" and corresponding metric range.
- Choice of an infinite number of backing materials.
- Choice of various colors and finishes available.
- Choice of various facing materials.

SCREW & BOLT SIZE		BACKING INNER DIAMETER		OUTER DIAMETER																														
mm	U.S. Standard	mm	Decimal	6.3	9.5	11	12	13	14	14	15	16	17.5	18.3	19	20	22	25	28	30	32	35	38	41.3	44.5	47.6	51	57	65.5	70	76	mm		
				1/4"	3/8"	7/16"	1/2"	5/8"	3/4"	7/8"	1"	1 1/8"	1 1/4"	1 3/8"	1 1/2"	1 5/8"	1 3/4"	1 7/8"	2"	2 1/4"	2 1/2"	2 3/4"	3"											
2.9	#4	3.3	.120	.	.	S	S	X	S	S	S	S	S	S	S	S	S	S	S	S	S	S	S	S	S	S	S	S	S	S	S	S	S	
3.5	#6	3.8	.150	.	.	S	S	X	S	S	S	S	X	S	S	S	S	S	S	S	S	S	S	S	S	S	S	S	S	S	S	S	S	S
4.2	#8	4.6	.180	.	.	.	.	.	S	S	S	.	S	X	S	S	S	S	S	S	S	S	S	S	S	S	S	S	S	S	S	S	S	S
4.8	#10	5.1	.200	.	.	.	.	.	.	X	.	.	S	.	.	S	.	.	S	S	S	S	S	S	S	S	S	S	S	S	S	S	S	X
5.5	#12	6.1	.230 .240	.	X	X	X	X	.	.	.	.	S	.	.	S	.	.	S	S	S	S	S	S	S	S	S	S	S	S	S	S	S	S
6.3	#14	7.0	.260 .275	.	.	.	.	.	.	.	.	.	S	.	.	S	.	.	S	S	S	S	S	S	S	S	S	S	S	S	S	S	S	S
7.5	#17	7.7	.305	.	.	.	.	.	.	.	.	.	S	.	.	S	.	.	S	S	S	S	S	S	S	S	S	S	S	S	S	S	S	S
8.0	5/16"	8.4	.330 .360	.	.	.	.	.	.	.	X	.	S	.	X	.	.	.	S	S	S	S	S	S	S	S	S	S	S	S	S	S	S	S
9.5	3/8"	11.0	.410 .434	.	.	.	.	.	.	.	.	.	S	.	X	.	.	.	S	S	S	S	S	S	S	S	S	S	S	S	S	S	S	S
11.1	7/16"	12.1	.475	.	.	.	.	.	.	.	.	.	S	.	X	.	.	.	S	S	S	S	S	S	S	S	S	S	S	S	S	S	S	S
12.7	1/2"	13.5	.532	.	.	.	.	.	.	.	.	.	S	.	X	.	.	.	S	S	S	S	S	S	S	S	S	S	S	S	S	S	S	S
14.0	9/16"	15.2	.600	.	.	.	.	.	.	.	.	.	S	.	X	.	.	.	S	S	S	S	S	S	S	S	S	S	S	S	S	S	S	S
15.9	5/8"	16.5	.650	.	.	.	.	.	.	.	.	.	S	.	X	.	.	.	S	S	S	S	S	S	S	S	S	S	S	S	S	S	S	S
17.5	11/16"	18.8	.720	.	.	.	.	.	.	.	.	.	S	.	X	.	.	.	S	S	S	S	S	S	S	S	S	S	S	S	S	S	S	S
19.0	3/4"	20.6	.810	.	.	.	.	.	.	.	.	.	S	.	X	.	.	.	S	S	S	S	S	S	S	S	S	S	S	S	S	S	S	S
22.2	7/8"	23.1	.910	.	.	.	.	.	.	.	.	.	S	.	X	.	.	.	S	S	S	S	S	S	S	S	S	S	S	S	S	S	S	S
25.4	1"	26.4	1.050	.	.	.	.	.	.	.	.	.	S	.	X	.	.	.	S	S	S	S	S	S	S	S	S	S	S	S	S	S	S	S
27.0	1-1/16"	28.0	1.100	.	.	.	.	.	.	.	.	.	S	.	X	.	.	.	S	S	S	S	S	S	S	S	S	S	S	S	S	S	S	S
28.6	1-1/8"	29.6	1.150	.	.	.	.	.	.	.	.	.	S	.	X	.	.	.	S	S	S	S	S	S	S	S	S	S	S	S	S	S	S	S
30.2	1-3/16"	31.0	1.220	.	.	.	.	.	.	.	.	.	S	.	X	.	.	.	S	S	S	S	S	S	S	S	S	S	S	S	S	S	S	S
31.8	1-1/4"	32.8	1.275	.	.	.	.	.	.	.	.	.	S	.	X	.	.	.	S	S	S	S	S	S	S	S	S	S	S	S	S	S	S	S
40.0	1-9/16"	40.6	1.6	.	.	.	.	.	.	.	.	.	S	.	X	.	.	.	S	S	S	S	S	S	S	S	S	S	S	S	S	S	S	S

\* Only available from stock with this inside diameter.

We suggest standard sizes for economy and availability

- **STANDARD OUTSIDE DIAMETERS**
- S **SPECIAL ORDER: TOOLING CHARGE AND/OR MINIMUM ORDER REQUIRED**
- X **NONSTANDARD ITEM: MINIMUM ORDER REQUIRED (TOOLING AVAILABLE)**

### BACKING MATERIALS:

- Galvanized Steel
- Aluminum
- Stainless Steel
- 316 Stainless Steel

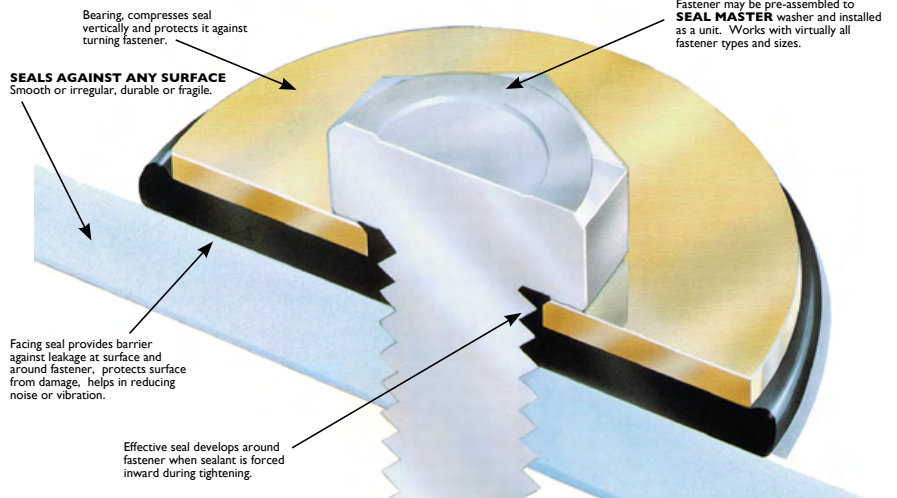
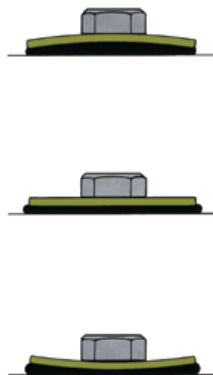

## MORE SEAL MASTER AND PLUG MASTER INFORMATION...

### SEAL IN... OR SEAL OUT

When installed in a sealing application, the materials in **ESTCO's SEAL MASTER** washer compress against either a flexible or an inflexible surface to permanently seal in or seal out any operating environment, whether natural or industrial. Facing materials are engineered to provide optimal resistance to weathering from ozone, ultraviolet light and/or chemical agents.

**ESTCO** can perform to your specifications or our experienced engineers can assist you in developing a specification for your application.

**ESTCO's** unique **SEAL MASTER** products are designed to provide a permanent seal in a wide variety of applications, including:

- Metal roofs and siding where the expansion and contraction of metal require a permanent resilient seal.
- Dishwashers - to avoid leaks.
- Marine - structural and electronic.
- Air filters - dust control.
- Automotive - air cleaner assemblies, engine block heater, emission control equipment, body sealing.

### Other useful applications include:

- Small and large appliances, such as vacuum cleaners and refrigerators.
- Heating ventilation/air conditioning (HVAC) equipment.
- Silos and tanks for liquids and solids.
- Exhaust systems.
- Panels and enclosures.
- Environmentally controlled areas.

### CUSHIONING AND VIBRATION CONTROL

Twenty-five years of proven experience in testing and retesting compounded formulas have led to the perfection of **ESTCO's SEAL MASTER** washers. Our washers possess extraordinary elasticity and memory when used in cushioning and vibration control applications.

As the washer is compressed and fastened against a substrate, the facing material serves as a permanent cushion. This feature protects the substrate from installation damage (spinning fastener and/or torque) and from vibration damage during the product's life cycle.

When utilized for cushioning, **SEAL MASTER** washers are especially effective on glass, plastic, fiberglass, porcelain and painted surfaces. The cushioning effect eliminates crazing, chipping and marring.

**SEAL MASTER** washers solve a variety of problems in numerous applications, including:

- Archery - protects sensitive compound bow sights.
- Motorcycles - protects fairings and components.
- Noise Control - electro-mechanical automotive devices and motor mounts for spray paint and other equipment
- Fragile surfaces - where crazing, cracking and chipping are problems.

### Other applications include:

- Glass and mirror installations. Architectural panels.

**SILICON-BRONZE, COPPER, COR-TEN®** and other special property metals are available for use in specific industrial applications and for aesthetics in architectural exposures.

**NON-METALLIC** backings, from phenolics to plastics, have been used in electronic and other environments where metals cannot be used.

### FACING MATERIALS

**ESTCO** offers a variety of facing materials to address the distinctly different operating environments to which **SEAL MASTER** washers are exposed.

**EPDM** (Ethylene Propylene Diene Terpolymer) is an excellent, low-cost, ozone and weather resistant elastomer which possesses superior aging characteristics. It is also extremely effective when application requirements dictate heat resistance up to 350°F. Although use of EPDM in direct contact with petrochemicals is not recommended for construction applications where the primary hazards are ozone, ultraviolet radiation and temperature extremes, EPDM is the consistent elastomer of choice.

**NEOPRENE®** (Polychloroprene), one of the earliest, and perhaps best known of the manmade elastomers, is still one of the most versatile facing materials for sealing and cushioning washers. When properly formulated, it is highly resistant to sunlight, ozone, weathering and aging, while enjoying good memory and elasticity. Although its particular strength lies in its resistance to petrochemicals and certain other chemical families, Neoprene is a generalist - performing well in a myriad of applications. When direct contact with petrochemicals is of greater concern than direct U. V., Neoprene will do the job.

**SILICONE** elastomers address the next tier of sealing washer applications. Temperature extremes from -115°F TO +480°F, exposures to specific chemical environments, or repeated sterilization cycles make Silicone the most economical, high-performance choice.

### FLUROSILICONES, VITONS, etc.

**ESTCO** works with the most current elastomeric compounds for today's most demanding rubber seal applications. These higher-cost exotics are intended to address only the most demanding and specific application criteria.

**NON-ELASTOMERIC** facings include asbestos substitutes, cork, fiber and malleable metals, each useful in select applications.

As each new application requires a specific combination of performance and cost factors, we cannot list specifications for all uses. Our applications engineers and chemists are prepared to discuss your requirements and to deliver years of experience, just for the asking!



# PLUG MASTER

Threaded Insert - Fastening, Sealing, Cushioning System.



## PLUG MASTER SIZE CHART

PART NUMBER		GRIP RANGE		BODY DIAMETER		OVERALL LENGTH		FLANGE O.D.		FLANGE THICKNESS		TORQUE	TENSILE
U.S.	METRIC	MIN	MAX	U.S.	METRIC	U.S.	METRIC	U.S.	METRIC	U.S.	METRIC	(In-lbs)	Pull Out
PM-6-32 S	PM-M3S	0.015	0.187	0.250	6.3mm	0.562	14mm	0.485	12.1mm	0.062	1.6mm	3.0	110.0
PM-6-32 L	PM-M3L	0.312	0.625	0.250	6.3	1.095	27.8	0.485	12.1	0.062	1.6	4.0	110.0
PM-6-32 PDI	PM-M3PDI	0.062	0.087	0.312	8	0.562	14	0.485	12.1	0.062	1.6	5.0	450.0
PM-8-32 S	PM-M4S	0.062	0.087	0.312	8	0.562	14	0.485	12.1	0.062	1.6	3.0	120.0
PM-8-32 L	PM-M4L	0.375	0.875	0.312	8	1.312	33	0.550	13.9	0.062	1.6	5.0	110.0
PM-10-32 S	PM-M5S	0.066	0.202	0.375	9.5	0.680	16	0.550	14	0.080	1.6	6.0	300.0
PM-10-32 F	PM-M5F	0.093	0.375	0.375	9.5	0.865	22	0.550	13.9	0.040	1.0	5.0	350.0
PM-10-32 L	PM-M5L	0.750	1.062	0.375	9.5	1.590	40	0.605	15.4	0.090	2.3	10.0	800.0
PM-1/4-20 S	PM-M6S	0.062	0.312	0.490	12.5	0.845	21	0.800	20.3	0.095	2.4	10.0	575.0
PM-1/4-20 SX	PM-M6SX	0.031	0.187	0.490	12.5	0.845	21	0.720	18.3	0.185	4.7	10.0	225.0
PM-1/4-20 SXX	PM-M6SXX	0.093	0.375	0.490	12.5	0.845	21	0.610	15.5	0.050	1.3	15.0	875.0
PM-1/4-20 J	PM-M6J	0.125	0.450	0.490	12.5	1.062	27	0.610	15.5	0.050	1.3	15.0	1250.0
PM-1/4-20 JX	PM-M6JX	0.125	0.450	0.490	12.5	1.260	32	0.735	18.7	0.240	6.1	15.0	200.0
PM-1/4-20 R	PM-M6R	0.375	0.625	0.490	12.5	1.275	32.4	0.835	21.2	0.100	2.5	10.0	425.0
PM-1/4-20 L	PM-M6L	0.375	0.750	0.490	12.5	1.850	47	0.970	24.6	0.110	2.8	20.0	950.0
PM-5/16-18 S	PM-M8S	0.024	0.150	0.610	15.5	0.840	21	0.970	24.6	0.110	2.8	25.0	775.0
PM-5/16-18 R	PM-M8R	0.250	0.750	0.610	15.5	1.625	41	1.200	30.5	0.125	3.2	15.0	425.0
PM-3/8-16 S	PM-M10S	0.024	0.437	0.740	18.8	1.062	27	1.220	31	0.125	3.2	30.0	1125.0
PM-3/8-16 SX	PM-M10SX	0.032	0.406	0.740	18.8	1.062	27	1.205	30.6	0.190	4.8	20.0	475.0

### ADAPTABILITY...

- Fastens blind holes and closed-end holes Cushions and seals similar and non-similar materials
- Absorbs vibration and seals both sides
- Tapered design enhances fastening installation
- Won't crack with ozone and ultra violet exposure

### VERSATILITY...

- Removable and re-insertable
- Installs with conventional tools
- Works as a system with SEAL MASTER washers
- Flange thickness always in proportion to size
- Grip range covers all dimensions.

### AVAILABILITY...

- Almost any color
- 12 Standard sizes and 6 fastener diameters
- EPDM. Custom materials may be available, please consult ESTCO.

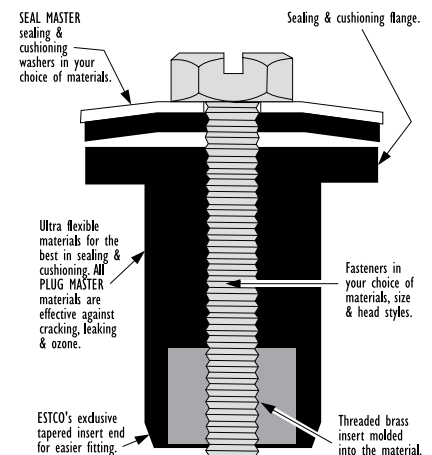
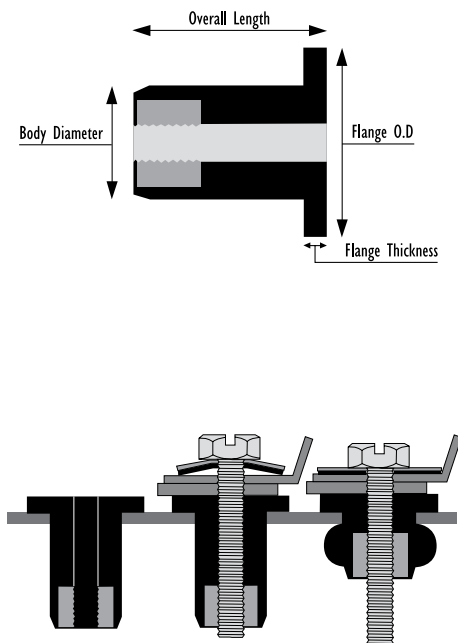

# STANDARD FLASH MASTER

ISO Quality, Price & Availability  
TWO COMPOUNDS/ 11 SIZES & 10 COLORS

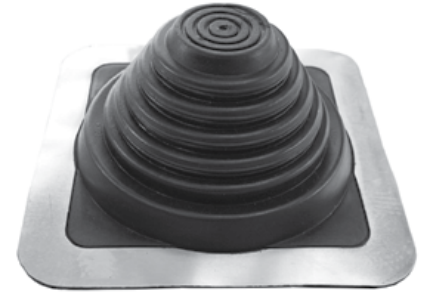

"Available in two compounds to handle virtually all job applications"

ADVANCED OZONE RESISTANCE tested to...	EPDM 70 hour @ 500 pphm	SILICONE 70 hour @ 500 pphm
HIGH TEMPERATURE RESISTANCE Tested to Intermittent Continuous	+135°C (+275°F) +100°C (+212°F)	+260°C (+500°F) +225°C (+437°F)
LOW TEMPERATURE RESISTANCE tested to...	- 55°C (-67°F)	-74°C (-101°F)
TENSILE SET maximum	10MPa (1450 psi)	5 MPa (700 psi)
COMPRESSION SET maximum...	25%	50%

\*Complete specification data and testing methods are available upon request.

	PIPE SIZE	COMPOUND	PART NO.	FLASHING DETAILS		
<b>Mini</b>	1/8" - 3/4" (3.2mm - 19.1 mm)	BLACK EPDM	FM-SQ051BA		A-Top opening diameter B-Cut to suit pipe size C-Base dimensions	1/16" (1.6mm) 1/8" - 3/4" (3.2-19.1mm) 2 - 1/4" (57.2mm)
<b>#1</b>	1/4" - 2-3/4" (6.4mm - 70mm)	BLACK EPDM	FM-SQ101BA		A-Top opening diameter	Closed
		GREY EPDM	FM-SQ101GA		B-Cut to suit pipe size	1/4" - 2-3/4" (6.4-70mm)
		SILICONE	FM-SQ102RA		C-Base dimensions	4-1/2" (114.3mm)
<b>#2</b>	7/8" - 4" (22mm - 101.5mm)	BLACK EPDM	FM-SQ201BA		A-Top opening diameter	7/8" (22.2mm)
		GREY EPDM	FM-SQ201GA		B-Cut to suit pipe size	7/8" - 4" (25 - 101.5mm)
		SILICONE	FM-SQ202RA		C-Base dimensions	6" (152.4mm)
<b>#3</b>	1/4" - 5-3/4" (6.3mm - 146mm)	BLACK EPDM	FM-SQ301BA		A-Top opening diameter	Closed
		GREY EPDM	FM-SQ301GA		B-Cut to suit pipe size	1/4" - 5-3/4" (6.3-146mm)
		SILICONE	FM-SQ302RA		C-Base dimensions	8" (203.2mm)
<b>#4</b>	2-3/4" - 7" (70mm - 177.8mm)	BLACK EPDM	FM-SQ401BA		A-Top opening diameter	2-3/4" (70mm)
		GREY EPDM	FM-SQ401GA		B-Cut to suit pipe size	2-3/4" - 7" (70 - 177.8mm)
		SILICONE	FM-SQ402RA		C-Base dimensions	10" (254mm)
<b>#5</b>	4" - 8-1/4" (102mm - 209.5mm)	BLACK EPDM	FM-SQ501BA		A-Top opening diameter	4" (102mm)
		GREY EPDM	FM-SQ501GA		B-Cut to suit pipe size	4" - 8-1/4" (102 - 209.5mm)
		SILICONE	FM-SQ502RA		C-Base dimensions	11" (279.4mm)
<b>#6</b>	4-3/4" - 10" (121mm - 254mm)	BLACK EPDM	FM-SQ601BA		A-Top opening diameter	4-3/4" (121mm)
		GREY EPDM	FM-SQ601GA		B-Cut to suit pipe size	4-3/4" - 10" (121-254mm)
		SILICONE	FM-SQ602RA		C-Base dimensions	12" (304.8mm)
<b>#7</b>	5-1/2" - 11-1/2" (140mm - 292mm)	BLACK EPDM	FM-SQ701BA		A-Top opening diameter	5-1/2" (140mm)
		GREY EPDM	FM-SQ701GA		B-Cut to suit pipe size	5-1/2" - 11-1/2" (140-292mm)
		SILICONE	FM-SQ702RA		C-Base dimensions	14" (355.6mm)
<b>#8</b>	6-3/4" - 13-1/2" (171.4mm - 343mm)	BLACK EPDM	FM-SQ801BA		A-Top opening diameter	6-3/4" (171.4mm)
		GREY EPDM	FM-SQ801GA		B-Cut to suit pipe size	6-3/4" - 13-1/2" (171.4 - 343mm)
		SILICONE	FM-SQ802RA		C-Base dimensions	17" (431.8mm)
<b>#9</b>	9-1/2" - 20-1/2" (241mm - 520mm)	BLACK EPDM	FM-SQ901BA		A-Top opening diameter	9-1/2" (241mm)
		GREY EPDM	FM-SQ901GA		B-Cut to suit pipe size	9-1/2" - 20-1/2" (241-520mm)
		SILICONE	FM-SQ902RA		C-Base dimensions	25" (635mm)
<b>Maxi</b>	12" - 28-1/2" (305mm - 724mm)	BLACK EPDM	FM-SQ951BA		A-Top opening diameter	12" (304mm)
		GREY EPDM	FM-SQ951GA		B-Cut to suit pipe size	12" - 28-1/2" (304 - 724mm)
		SILICONE	FM-SQ952RA		C-Base dimensions	34" (863.6mm)

- Weather Protection**  
 Made of E.P.D.M. Silicone.  
 These flashings are compounded specifically for maximum resistance to weathering due to ozone and Silicone, ultraviolet light.

- Easy On-Site Customization**  
 Fast, one piece construction allows for easy on-site installation in usually 5 minutes.

- Base Flexibility**  
 The base is designed to form a seal on most panel configurations and roof pitches regardless of pipe location.

- Design Excellence**  
 ESTCO's flexible design meets all roofing needs. Sleeve flexibility accommodates vibration and pipe movement caused by expansion contraction. The soft aluminum base easily conforms to most metal roof profiles.

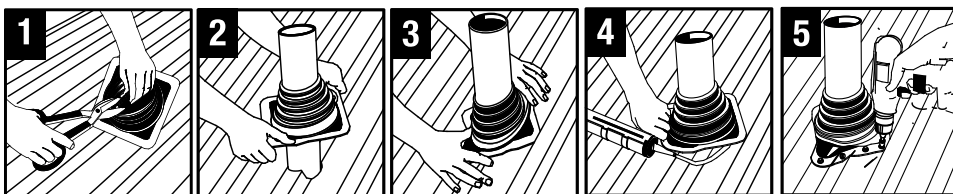

1 Choose Pipe Opening and Trim    2 Slide Over Pipe    3 Form to Roof Profile    4 Apply Sealant    5 Fasten to Complete





# UNIVERSAL FLASH MASTER

ISO Quality, Price & Availability  
TWO COMPOUNDS/ 9 SIZES & 10 COLORS



"Available in two compounds to handle virtually all job applications"

### • Ozone and UV Protection

Flashings are made of E.P.D.M or Silicone, and are designed for maximum resistance to all weather conditions.

### • On-Site Customization

Pipe diameters can be seen clearly for proper fitting.

### • Adaptable Base

The base is designed to mold to most panel configurations and roof pitches regardless of pipe location.

### • All Around Design Excellence

This universal flashing has been designed to fit virtually all panel configurations. Sleeve flexibility absorbs vibration and pipe movement caused by expansion/contraction. Easy on-site customization can accommodate all normal installations.



ADVANCED OZONE RESISTANCE tested to...	EPDM 70 hour @ 500 pphm	SILICONE 70 hour @ 500 pphm
HIGH TEMPERATURE RESISTANCE Tested to Intermittent Continuous	+135°C (+275°F) +100°C (+212°F)	+260°C (+500°F) +225°C (+437°F)
LOW TEMPERATURE RESISTANCE tested to...	-55°C (-67°F)	-74°C (-101°F)
TENSILE SET maximum	10MPa (1450 psi)	5 MPa (700 psi)
COMPRESSION SET maximum...	25%	50%

\*Complete specification data and testing methods are available upon request.

### SIZING CHART

Check diameter of pipe. Select the appropriate Universal Flash Master for pipe or duct diameter. For extreme pitch or surface irregularity select next larger size. Choose the compound required, then refer to the part number for the Universal FlashMaster desired.

	PIPE SIZE	COMPOUND	PART NO.	FLASHING DETAILS		
#1	1/4" - 2-1/2" (6.35 - 63.5mm)	BLACK EPDM	FM-RD101BE		A-Top Opening Diameter	Closed
		GREY EPDM	FM-RD101GG		B- Overall Height	2.77" (70.4mm)
		SILICONE	FM-RD101RG		C-Base Diameter	4.75" (120.7mm)
#2	1-3/4" - 3" (44.5 - 76.2mm)	BLACK EPDM	FM-RD201BE		A-Top Opening Diameter	1.44" (36.6mm)
		GREY EPDM	FM-RD201GG		B- Overall Height	3.53" (89.7mm)
		SILICONE	FM-RD201RG		C-Base Diameter	6.21" (157.7mm)
#3	1/4" - 5" (6.35 - 127mm)	BLACK EPDM	FM-RD301BE		A-Top Opening Diameter	Closed
		GREY EPDM	FM-RD301GG		B- Overall Height	3.64" (92.5mm)
		SILICONE	FM-RD301RG		C-Base Diameter	7.74" (196.6mm)
#4	3" - 6-1/4" (76.2 - 158.8mm)	BLACK EPDM	FM-RD401BE		A-Top Opening Diameter	2.38" (60.5mm)
		GREY EPDM	FM-RD401GG		B- Overall Height	5.05" (128.3mm)
		SILICONE	FM-RD401RG		C-Base Diameter	9.26" (235.2mm)
#5	4-1/4" - 7-3/4" (108 - 196.9mm)	BLACK EPDM	FM-RD501BE		A-Top Opening Diameter	3.50" (88.9mm)
		GREY EPDM	FM-RD501GG		B- Overall Height	4.43" (112.5mm)
		SILICONE	FM-RD501RG		C-Base Diameter	10.75" (273.1mm)
#6	5" - 9" (127 - 228.6mm)	BLACK EPDM	FM-RD601BE		A-Top Opening Diameter	4.25" (108mm)
		GREY EPDM	FM-RD601GG		B- Overall Height	5.60" (142.2mm)
		SILICONE	FM-RD601RG		C-Base Diameter	12.50" (317.5mm)
#7	6" - 11" (152.4 - 279.4mm)	BLACK EPDM	FM-RD701BE		A-Top Opening Diameter	4.90" (124.5mm)
		GREY EPDM	FM-RD701GG		B- Overall Height	5.84" (148.3mm)
		SILICONE	FM-RD701RG		C-Base Diameter	14.60" (370.8mm)
#8	7" - 13" (177.8 - 330.2mm)	BLACK EPDM	FM-RD801BE		A-Top Opening Diameter	5.80" (147.3mm)
		GREY EPDM	FM-RD801GG		B- Overall Height	7.53" (191.3mm)
		SILICONE	FM-RD801RG		C-Base Diameter	16.5" (419.1mm)
#9	9" - 19" (228.6 - 482.6mm)	BLACK EPDM	FM-MFR9B		A-Top Opening Diameter	7.45" (189.2mm)
		GREY EPDM	FM-MFR9G		B- Overall Height	8.09" (205.5mm)
		SILICONE	FM-MFR9S		C-Base Diameter	25.25" (641.4mm)





# MULTI-FLASH FLASH MASTER

“Two Flashings In One”

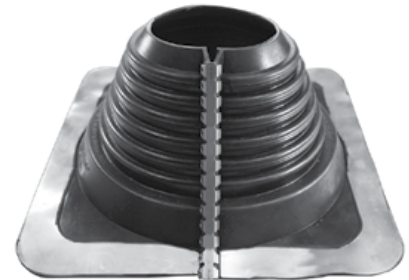

ADVANCED OZONE RESISTANCE tested to...	EPDM 70 hour @ 500 pphm	SILICONE 70 hour @ 500 pphm
HIGH TEMPERATURE RESISTANCE Tested to Intermittent Continuous	+135°C (+275°F) +100°C (+212°F)	+260°C (+500°F) +225°C (+437°F)
LOW TEMPERATURE RESISTANCE tested to...	-55°C (-67°F)	-74°C (-101°F)
TENSILE SET maximum	10MPa (1450 psi)	5 MPa (700 psi)
COMPRESSION SET maximum...	25%	50%

\*Complete specification data and testing methods are available upon request.

	PIPE SIZE	COMPOUND	PART NO.		FLASHING DETAILS	
#1	STANDARD 1/4" - 2-3/4" (6 mm to 70 mm)	BLACK EPD	FM-MF101BA		A - Top opening diameter	CLOSED
	RETROFIT 1-1/4" - 2-1/4" (25 mm to 57 mm)	RED SILICONE	FM-MF102RA		B - Base dimensions	4-1/2"
#3	STANDARD 1/4" - 5-3/4" (6 mm to 146 mm)	BLACK EPD	FM-MF301BA		A - Top opening diameter	CLOSED
	RETROFIT 2" - 4-1/2" (50.8 mm to 114 mm)	RED SILICONE	FM-MF302RA		B - Base dimensions	8"
#5	STANDARD 4" - 8-1/4" (102 mm to 209 mm)	BLACK EPDM	FM-MF501BA		A - Top opening diameter	3-1/2"
	RETROFIT 3-1/2" - 6-3/4" (88.9 mm to 171.4 mm)	RED SILICONE	FM-MF502RA		B - Base dimensions	11"
#8	STANDARD 6-3/4" - 13-1/2" (171 mm to 342 mm)	BLACK EPDM	FM-MF801BA		A - Top opening diameter	6"
	RETROFIT 6-1/2" - 12" (165.1 mm to 304 mm)	RED SILICONE	FM-MF802RA		B - Base dimensions	17"
Maxi	STANDARD 12" - 28-1/2" (304 mm to 724 mm)	BLACK EPDM	FM-MF951BA		A - Top opening diameter	11"
	RETROFIT 13" - 27" (330.2 mm to 685 mm)	RED SILICONE	FM-MF802RA		B - Base dimensions	34"

- Weather Protection**  
 Made of E.P.D.M. Silicone. These flashings are compounded specifically for maximum resistance to weathering due to ozone and Silicone, ultraviolet light.
- A "C12" ASTM**  
 Additional requirement was added to assure conformance to the most stringent ozone/weathering specifications available.
- Base Flexibility**  
 The base is designed to form a seal on most panel configurations and roof pitches regardless of pipe location.
- EASY ON SITE CUSTOMIZING**  
 Smooth cut is intended to eliminate use of razor blades. Stainless steel gripper to secure a retro custom fit. (GRIPPER SOLD SEPARATELY.)



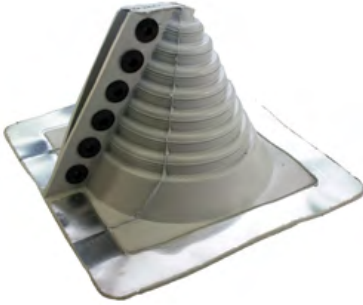

# STANDARD RETROFIT FLASH MASTER

Two Compounds / 3 Sizes



- Weather Resistance**  
 Designed to withstand the damaging effects of ultra violet light and ozone.
- Modification Made Simple**  
 Easy to see pipe diameters make for painless on site customization.
- Malleable Base**  
 Designed to conform to most panel configurations and roof pitches regardless of pipe location.
- Easily Installed Fastener Snaps**  
 Included.

	PIPE SIZE	COMPOUND	PART NO.	FLASHING DETAILS		
#1	1/2" - 4" (12.7 - 101.6mm)	BLACK EPDM GREY EPDM SILICONE	FM-RF101BP FM-RF101GP FM-RF102RS		A-Top opening diameter B-Cut to suit pipe size C-Base dimensions	1/2" (12.7mm) 1/2" - 4" (12.7 - 101.6mm) 8-3/16" (81mm)
#2	4" - 9-1/4" (101.6 - 135mm)	BLACK EPDM GREY EPDM SILICONE	FM-RF201BP FM-RF201GP FM-RF202RS		A-Top opening diameter B-Cut to suit pipe size C-Base dimensions	4" (101.6mm) 4" - 9-1/4" (101.6 - 235mm) 14-1/4" (362mm)
#3	9-1/4" - 16-1/4" (235 - 412.8mm)	BLACK EPDM GREY EPDM SILICONE	FM-RF301BP FM-RF301GP FM-RF302RS		A-Top opening diameter B-Cut to suit pipe size C-Base dimensions	9-1/4" (235 - 412.7mm) 9-1/4" x 16-1/4" (235 - 412.7mm) 21-1/2" (546.1mm)

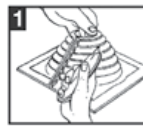

1 Choose appropriate Retrofit. If necessary trim opening to pipe diameter.

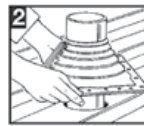

2 Wrap Retrofit around pipe and install all snap rivets to seal flange

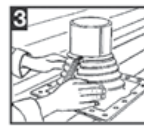

3 Press Master Flash™ down, bending it to conform to roof profile or roof irregularities. A blunt tool will help press flashing into tight roof angles.

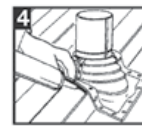

4 Apply silicone sealant between base, roof, and to the top of flashing

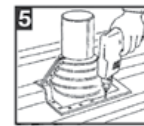

5 Use fasteners to complete sealing. For UPC installation, fastener spacing may not exceed 1-1/2" (38mm)

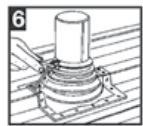

6 Install supplied cable tie at uppermost part of Retrofit and apply sealant to any gaps.



ISO 9001 Certified  
CERTIFICATE # 08-511

# UNIVERSAL RETROFIT FLASH MASTER

ISO Quality, Price & Availability  
Two Compounds / 3 Sizes



	PIPE SIZE	COMPOUND	PART NO.	FLASHING DETAILS		
#1	3/4" - 2-3/4" (19 - 69mm)	BLACK EPDM GREY EPDM SILICONE	FM-RF101BS-RD		A-Top opening diameter	3/4"(19.1mm)
			FM-RF101GS-RD		B-Cut to suit pipe size	3/4" - 2-3/4" (19 - 69mm)
			FM-RF102RS-RD		C-Base dimensions	6 - 3/10" (160mm)
#2	2" - 7-1/4" (50.8 - 184mm)	BLACK EPDM GREY EPDM SILICONE	FM-RF201BS-RD		A-Top opening diameter	2" (50.8mm)
			FM-RF201GS-RD		B-Cut to suit pipe size	2" - 7-1/4" (50.8 - 184mm)
			FM-RF202RS-RD		C-Base dimensions	10-3/4" (273mm)
#3	3-1/4" - 10" (95 - 254mm)	BLACK EPDM GREY EPDM SILICONE	FM-RF301BS-RD		A-Top opening diameter	3-1/4 - 10" (50.8mm)
			FM-RF301GS-RD		B-Cut to suit pipe size	1/4" - 5" (82.5 - 253.9mm)
			FM-RF302RS-RD		C-Base dimensions	14-1/2" (368mm)

- **Weather Protection**  
Made of E.P.D.M. or Silicone, These flashings are compounded specifically for maximum resistance to weathering due to ozone and ultraviolet light.
- **Easy On-Site Customization**  
Fast, one piece construction allows for easy on-site install in usually 5 minutes.
- **Flexible Base**  
Easily forms to contours of roof panel.

**Step 1:** For retrofit installation, cut center rubber at base of the stainless joiner and pull apart.

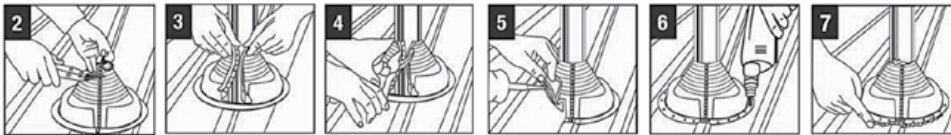

2 Using tin snips, cut the flashing to fit pipe, starting opposite the Gripper

3 Wrap Retrofit around pipe, join the interlocking teeth starting from the top and proceeding down.

4 Squeeze Gripper tightly with pliers to crimp, start at the top and work down to the base.

5 Apply sealant to the underside of the base. Shape Retrofit to roof by pressing the aluminum base to the roof contours.

6 Fasten Retrofit to roof using self-drilling screws, leave no gaps between base and the roof contours.

7 Apply additional sealant to Gripper joiner seam and to all areas that could be a potential leak risk.



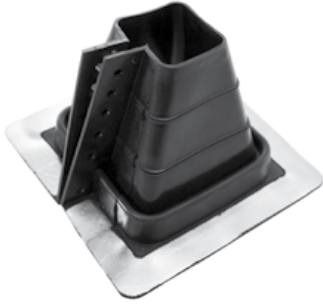

ISO 9001 Certified  
CERTIFICATE # 08-511



## SQUARE VENT FLASH MASTER

- Made for Weather Resistance**  
 Made to withstand the damaging effects of ultraviolet light and Ozone.
- Roof Adaptability**  
 The base is designed to mold to most panel configurations and roof pitches regardless of pipe location.
- Cut to Fit**  
 Easy to see pipe diameters make for painless on site customization.
- Easy Install Snaps Included**
- Design Excellence**  
 Specially designed for square vent applications, sleeve flexibility accommodates vibration and pipe movement caused by expansion/contraction. Easy on-site customization accommodates all normal installations.

	PIPE SIZE	COMPOUND	PART NO.	FLASHING DETAILS	
#1	2-1/2" - 4" (63-101mm)	BLACK EPDM	FM-RF101BP-SQ		A-Top opening diameter 2-1/2" (63mm) B-Cut to suit pipe size 2-1/2" to 4" (63-101mm) C-Base dimensions 8" (203.2mm)
#2	2-1/4" - 5" (57-127mm)	BLACK EPDM	FM-RF201BP-SQ		A-Top opening diameter 2-1/4" (57mm) B-Cut to suit pipe size 2-1/4" to 5" (57-127mm) C-Base dimensions 15-3/4" (400mm)



# RESIDENTIAL FLASH MASTER



	PIPE SIZE	COMPOUND	PART NO.	FLASHING DETAILS		
<b>MINI</b>	1/4" - 3" 6.35 - 76.2mm	BLACK EPDM GREY EPDM SILICONE	<b>FM-RS051BA</b> <b>FM-RS051GA</b> <b>FM-RS052RA</b>		A-Top opening diameter B-Cut to suit pipe size C-Base dimensions	Closed 1/4" - 3" (6.35 - 76.2mm) 16" X 9-1/4" (410 X 490mm)
<b>#1</b>	3" - 8" 76.2 - 203.2mm	BLACK EPDM GREY EPDM SILICONE	<b>FM-RS101BA</b> <b>FM-RS101GA</b> <b>FM-RS102RA</b>		A-Top opening diameter B-Cut to suit pipe size C-Base dimensions	2-1/2" (63.5mm) 3" - 8" (76.2 - 203.2mm) 20" X 24" (508 X 609.5mm)
<b>#2</b>	8" - 11" 203.1 - 279.4mm	BLACK EPDM GREY EPDM SILICONE	<b>FM-RS201BA</b> <b>FM-RS201GA</b> <b>FM-RS202RA</b>		A-Top opening diameter B-Cut to suit pipe size C-Base dimensions	5-5/8" (142.875mm) 8" - 11" (203.1 - 279.4 mm) 26" X 30" (660.3 X 762mm)
<b>#3</b>	11" - 18" 279.4 - 457mm	BLACK EPDM GREY EPDM SILICONE	<b>FM-RS301BA</b> <b>FM-RS301GA</b> <b>FM-RS302RA</b>		A-Top opening diameter B-Cut to suit pipe size C-Base dimensions	8-3/4" (222.2mm) 11" - 18" (279.4 - 457mm) 35" - 35" (889 X 889mm)

- The addition of fire retarding agents milled directly into the rubber compound creates a self extinguishing feature which enables it to be used with type "B" vents. Listed with **IAPMO certification No.3121**

- The pull tab design and easy smooth tear grooving is intended to eliminate razor knived and allow for a circular hole

- "Environmentally safe" lead free aluminum base.

Four Sizes Accommodate Flues & Vents From 1/4" Diameter Through 18" Diameter.

**EPDM Rubber is available in black and grey or Silicone is available.**

- A "C20" ASTM additional requirement was added to assure conformance to the most stringent ozone/weathering specifications available. This addition allows the rubber a 20 year life.

- The built in 20° pitch allows adaptability to almost any roof pitch including 45°



Wood Shingle



Tar Paper/Asphalt Shingles



Clay Tile

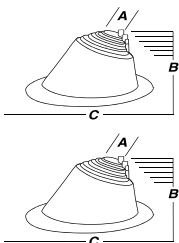

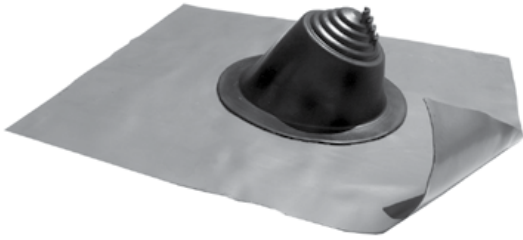

## RES-LEAD FLASH MASTER

“Powder Coated Safe Lead”

- **Weather Protection**

Made of EPDM or Silicone, these flashings are compounded specifically for maximum resistance to weathering due to ozone and ultraviolet light.

- The pull tab design and easy smooth tear grooving is intended to eliminate razor knives and allow for a circular hole.
- The built in 20° pitch allows adaptability to almost any roof pitch including 45°
- A “C20” ASTM additional requirement was added to assure conformance to the most stringent ozone/weathering specifications available. This addition allows the rubber a 20 year life.
- “ENVIRONMENTALLY SAFE”  
Powder coated Safe-Lead metal base.

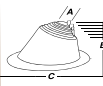
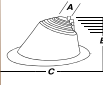
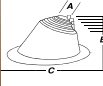
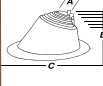
	PIPE SIZE	COMPOUND	PART NO.	FLASHING DETAILS		
<b>MINI</b>	1/4" - 3" 6.35 - 76.2mm	BLACK EPDM GREY EPDM SILICONE	<b>FM-RL051BA</b> <b>FM-RL051GA</b> <b>FM-RL052RA</b>		A-Top opening diameter B-Cut to suit pipe size C-Base dimensions	Closed 1/4" - 3" (6.35 - 76.2mm) 16" X 9-1/4" (410 X 490mm)
<b>#1</b>	3" - 8" 76.2 - 203.2mm	BLACK EPDM GREY EPDM SILICONE	<b>FM-RL101BA</b> <b>FM-RL101GA</b> <b>FM-RL102RA</b>		A-Top opening diameter B-Cut to suit pipe size C-Base dimensions	2-1/2" (63.5mm) 3" - 8" (76.2 - 203.2mm) 20" X 24" (508 X 609.5mm)
<b>#2</b>	8" - 11" 203.1 - 279.4mm	BLACK EPDM GREY EPDM SILICONE	<b>FM-RL201BA</b> <b>FM-RL201GA</b> <b>FM-RL202RA</b>		A-Top opening diameter B-Cut to suit pipe size C-Base dimensions	5-5/8" (142.875mm) 8" - 11" (203.1 - 279.4 mm) 26" X 30" (660.3 X 762mm)
<b>#3</b>	11" - 18" 279.4 - 457mm	BLACK EPDM GREY EPDM SILICONE	<b>FM-RL301BA</b> <b>FM-RL301GA</b> <b>FM-RL302RA</b>		A-Top opening diameter B-Cut to suit pipe size C-Base dimensions	8-3/4" (222.2mm) 11" - 18" (279.4 - 457mm) 35" - 35" (889 X 889mm)

**EPDM rubber is available in black and grey or Silicone**

**\*Custom colors are available upon request, an additional cost may apply.**



### RES-LEAD FLASH MASTER RUBBER COLORS...

White, grey, black, light and dark green, light and dark blue, terra cotta (red clay appearance) and bright red. Base coloring options are available an additional cost may apply.



ISO 9001 Certified  
CERTIFICATE # 08-511

# MASTER-CAP FLASH MASTER

## ALL NEW - Standing Seam Roof End Cap Flashing



ISO Quality, Price & Availability

ADVANCED OZONE RESISTANCE tested to...	EPDM 70 hour @ 500 pphm
HIGH TEMPERATURE RESISTANCE Tested to Intermittent Continuous	+135°C (+275°F) +100°C (+212°F)
LOW TEMPERATURE RESISTANCE tested to...	- 55°C (-67°F)
TENSILE SET maximum	10MPa (1450 psi)
COMPRESSION SET maximum...	25%

\*Complete specification data and testing methods are available upon request.

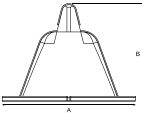
	COMPOUND	PART NO.	FLASHING DETAILS		
MASTER CAP	BLACK EPDM	FM-MC101BA		A-Width B-Height	4" (101mm) 3-1/4" (82 mm)



### Flexibility

- Expansion feature accommodates all 3" seam heights.
- Flexible width allows for most panel configurations.

### Base Features

- Allows side wall of end cap to form on roof panels.
- 3" base allows application at both terminating points of the sheeting or roofing material.
- Made of E.P.D.M., these flashings are compounded specifically for maximum resistance to weathering due to ozone and ultraviolet light.
- Available in a variety of color options.

## Applications:

Skylights • Metal Curbs • Ridge Applications • Jobsite Retrofit

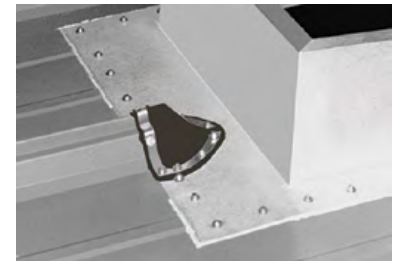
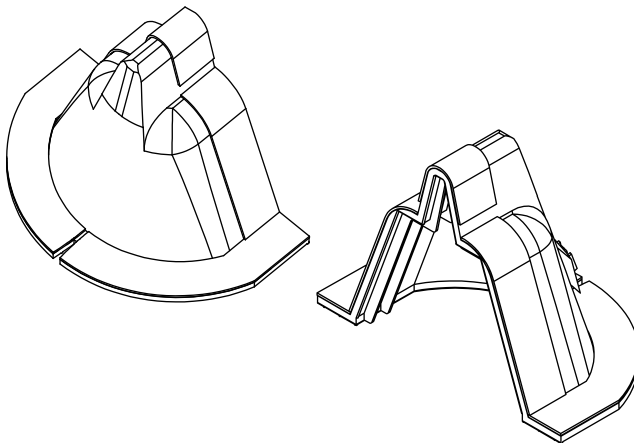



## SOLAR-FLASH FLASH MASTER



- The simple round base flashing is available in EPDM and silicone with a pre-cut hole for pipe sizes 3/4" to 1" inch allowing for minimal on-site preparation and assembly.
- The pitch canal allows for maximum flexibility, easy accommodating up to a 60 degree pitch without affecting performance.
- Ozone and UV Protection  
Flashings are made of EPDM and Silicone, and are designed for maximum resistance to all weather conditions.

ADVANCED OZONE RESISTANCE tested to...	EPDM 70 hour @ 500 pphm	SILICONE 70 hour @ 500 pphm
HIGH TEMPERATURE RESISTANCE Tested to Intermittent Continuous	+135°C (+275°F) +100°C (+212°F)	+260°C (+500°F) +225°C (+437°F)
LOW TEMPERATURE RESISTANCE tested to...	-55°C (-67°F)	-74°C (-101°F)
TENSILE SET maximum	10MPa (1450 psi)	5 MPa (700 psi)
COMPRESSION SET maximum...	25%	50%

PIPE RANGE	COMPOUND	PART NO.	FLASHING DETAILS	
3/4" - 1" (19 - 25.3mm)	BLACK EPDM	FM-SF101BA		A-Top Opening Diameter .60" (15.24mm)
	SILICONE	FM-SF101RA		B-Overall Height 2-1/2" (63.5mm) C-Base Diameter 4" (101.6mm)



## Mini Standard Flash Master

Specifically designed for solar & electrical applications

ISO Quality, Price & Availability / TWO COMPOUNDS / 10 COLORS

- **Weather Protection**  
Made of E.P.D.M. or Silicone, these flashings are compounded specifically for maximum resistance to weathering due to ozone and ultraviolet light.
- **Easy On-Site Customization**  
Fast, one piece construction allows for easy on-site installation in minutes.
- **Base Flexibility**  
The base is designed to form a seal on most panel configurations and roof pitches regardless of pipe/wire location.
- **Nine color options available**

ADVANCED OZONE RESISTANCE tested to...	EPDM 70 hour @ 500 pphm	SILICONE 70 hour @ 500 pphm
HIGH TEMPERATURE RESISTANCE Tested to Intermittent Continuous	+135°C (+275°F) +100°C (+212°F)	+260°C (+500°F) +225°C (+437°F)
LOW TEMPERATURE RESISTANCE tested to...	-55°C (-67°F)	-74°C (-101°F)
TENSILE SET maximum	10MPa (1450 psi)	5 MPa (700 psi)
COMPRESSION SET maximum...	25%	50%

PIPE RANGE	COMPOUND	PART NO.	FLASHING DETAILS	
(1/8" - 3/4") 3.2mm - 19.1 mm	BLACK EPDM	FM-SQ101BA		A-Top opening diameter 1/16" (1.6mm)
	Grey EPDM	FM-SQ101GA		B-Cut to suit pipe size 3.2-19.1mm (1/8" - 3/4")
	SILICONE	FM-SQ101RA		C-Base dimensions 57.2mm (2 - 1/4")





# MULTI-PORT FLASH MASTER

Two Applications • One Design • Multiple Functions

ISO Quality, Price & Availability TWO COMPOUNDS

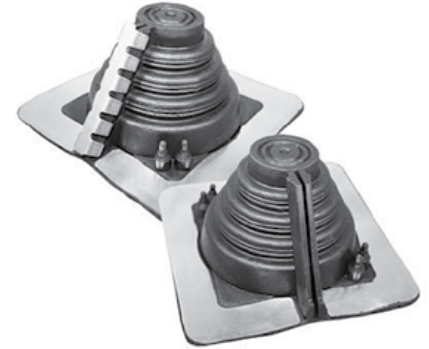

ADVANCED OZONE RESISTANCE tested to...	EPDM 70 hour @ 500 pphm	SILICONE 70 hour @ 500 pphm
HIGH TEMPERATURE RESISTANCE Tested to Intermittent Continuous	+135°C (+275°F) +100°C (+212°F)	+260°C (+500°F) +225°C (+437°F)
LOW TEMPERATURE RESISTANCE tested to...	-55°C (-67°F)	-74°C (-101°F)
TENSILE SET maximum	10MPa (1450 psi)	5 MPa (700 psi)
COMPRESSION SET maximum...	25%	50%

\*Complete specification data and testing methods are available upon request.

Accommodates FOUR 1/4" (6mm) lines and 1 pipe 1/4" - 2-3/4" (6 - 70mm)  
Up to 4 Cables or Wires per flashing.

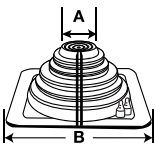
PIPE RANGE	COMPOUND	PART NO.	FLASHING DETAILS		
STANDARD 1/4"-2-3/4" (6 - 70mm)	BLACK EPDM	FM-MP101BA		A-Base Diameter	Standard Only Closed
	SILICONE	FM-MP101RA		B-Base Diameter	4-1/2" (114mm)

- **Ozone and UV Protection**  
Flashings are made of EPDM and Silicone, and designed for maximum resistance to all weather conditions.
- **No Hassle Gripper**  
Single stainless steel gripper to secure retrofit applications only.
- **Adaptable Base**  
The base is designed to mold to most panel configurations and roof pitches regardless of pipe location.

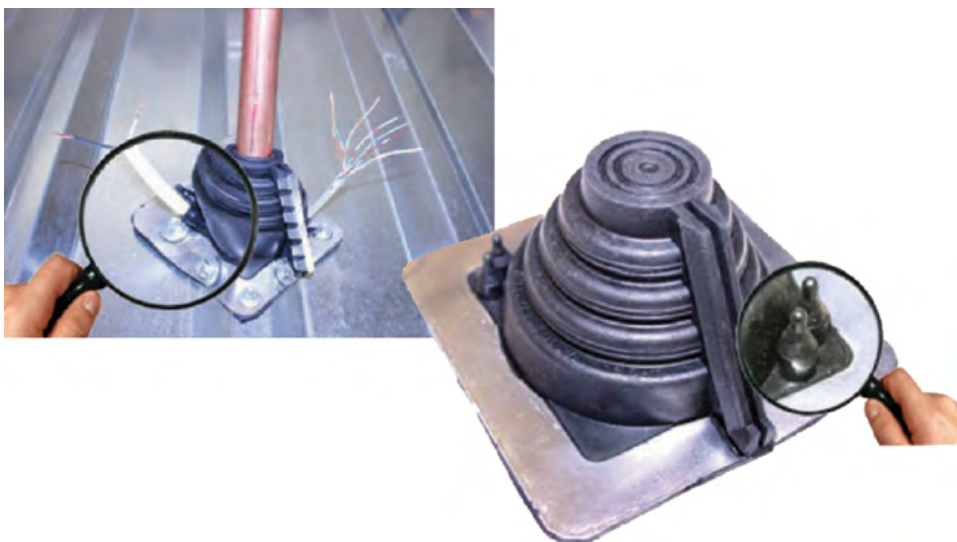



**35**  
YEAR  
WARRANTY

### NEW - 35 YEAR FLASH MASTER

The only ICC listed flashing for the Metal Building Industry with a 35 year warranty

ICC & ISO Quality, Price & Availability / 9 Sizes

- 9 sizes
- Made of epdm, this flashing Resistance to all weather Conditions.
- The base is designed to fit virtually all panel configurations and roof pitches regardless of pipe location.
- On site customization.
- Ozone and uv protected.
- Designed for 1/4" to 13" diameter pipes.
- Virtually all panel configurations and roof pitches regardless of pipe location.
- Pipe diameters can be seen clearly for proper pipe fitting.
- Flexibility absorbs vibration and pipe movement.

ADVANCED OZONE RESISTANCE tested to...	EPDM 70 hour @ 500 pphm	SILICONE 70 hour @ 500 pphm
HIGH TEMPERATURE RESISTANCE Tested to Intermittent Continuous	+135°C (+275°F) +100°C (+212°F)	+260°C (+500°F) +225°C (+437°F)
LOW TEMPERATURE RESISTANCE tested to...	-55°C (-67°F)	-74°C (-101°F)
TENSILE SET maximum	10MPa (1450 psi)	5 MPa (700 psi)
COMPRESSION SET maximum...	25%	50%

#### SIZING CHART

Check diameter of pipe. Select the appropriate 35 Year Flash Master for pipe or duct diameter. Only use maximum pipe diameters on minimal roof angles. For extreme pitch or surface irregularity select next larger size. Then refer to the part number for the 35 Year Flash Master desired.

	PIPE SIZE	COMPOUND	PART NO.	FLASHING DETAILS	
Mini	1/8" - 3/4" (3.2 mm - 19.1 mm)	BLACK EPDM	FM-ICC-SQ051B		A-Top opening diameter 1/16" (1.6mm) B-Cut to suit pipe size 1/8" - 3/4" (3.2-19.1 mm) C-Base dimensions 2 - 1/4" (57.2 mm)
#1	1/4" - 2" (6.4 mm - 50.8 mm)	BLACK EPDM	FM-ICC-SQ101B		A-Top opening diameter Closed B-Cut to suit pipe size 1/4" - 2" (6.4 -50.8 mm) C-Base dimensions 4-1/2" (114.3 mm)
#2	1-1/4" - 3" (31.8 mm - 76.2 mm)	BLACK EPDM	FM-ICC-SQ201B		A-Top opening diameter 7/8" (22.2 mm) B-Cut to suit pipe size 1-1/4" - 3" (31.8 - 76.2 mm) C-Base dimensions 6" (152.4mm)
#3	1/4" - 4" (6.3 mm - 101.6 mm)	BLACK EPDM	FM-ICC-SQ301B		A-Top opening diameter Closed B-Cut to suit pipe size 1/4" - 4" (6.3 -101.6 mm) C-Base dimensions 8" (203.2 mm)
#4	3" - 6" (76.2 mm - 152.4 mm)	BLACK EPDM	FM-ICC-SQ401B		A-Top opening diameter 2-1/2" (63.5 mm) B-Cut to suit pipe size 3" - 6" (76.2 -152 mm) C-Base dimensions 10" (254 mm)
#5	4" - 7" (102 mm - 177.8 mm)	BLACK EPDM	FM-ICC-SQ501B		A-Top opening diameter 3-1/2" (88.9 mm) B-Cut to suit pipe size 4" - 7" (102 - 177.8 mm) C-Base dimensions 11" (279.4 mm)
#6	5" - 9" (127 mm - 228.6 mm)	BLACK EPDM	FM-ICC-SQ601B		A-Top opening diameter 4" (101.6 mm) B-Cut to suit pipe size 5" - 9" (127 - 228.6 mm) C-Base dimensions 12" (304.8 mm)
#7	6" - 11" (152.4 mm - 279.4 mm)	BLACK EPDM	FM-ICC-SQ701B		A-Top opening diameter 5" (127 mm) B-Cut to suit pipe size 6" - 11" (152.4 - 279.4 mm) C-Base dimensions 14" (355.6 mm)
#8	7" - 13" (177.8 mm - 330.2 mm)	BLACK EPDM	FM-ICC-SQ801B		A-Top opening diameter 6" (152.4 mm) B-Cut to suit pipe size 7" - 13" (177.8 - 330 mm) C-Base dimensions 17" (431.8 mm)



#### 35 Year Flash Master

Compliance with the following codes:

- 2006 International Building Code® (IBC)
- 2006 International Residential Code® (IRC)

ICC-ES is the United States' leading source of technical information on building products and building technology for code compliance.

ICC-ES performs technical evaluations of building products, components, methods and materials.

The evaluation process culminates with the issuance of reports on compliance with the major U.S. building codes, which are available at [www.icc-es.org](http://www.icc-es.org).

ICC-ES is a subsidiary of the International Code Council, a membership association dedicated to building safety and fire prevention that develops the codes used to construct residential and commercial buildings, including homes and schools. Most U.S. cities, counties and states that adopt codes choose the International Codes developed by the International Code Council.

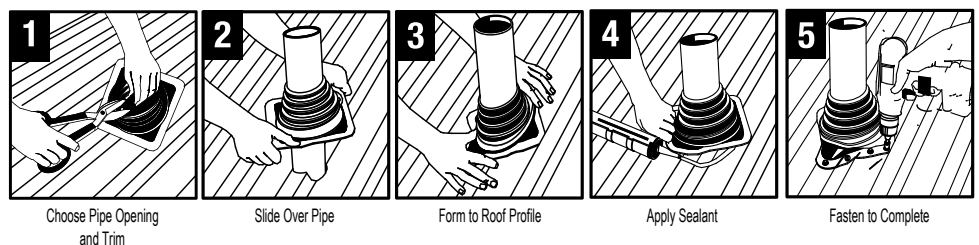

# SELF-FUSING TAPES

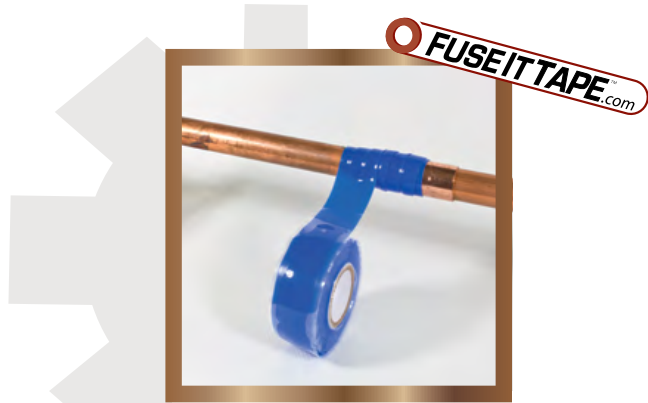

**Self-Fusing Silicone Sealing Tape**  
5-2



**SFT - Silicone, Self-Fusing Electrical Tape**  
5-3

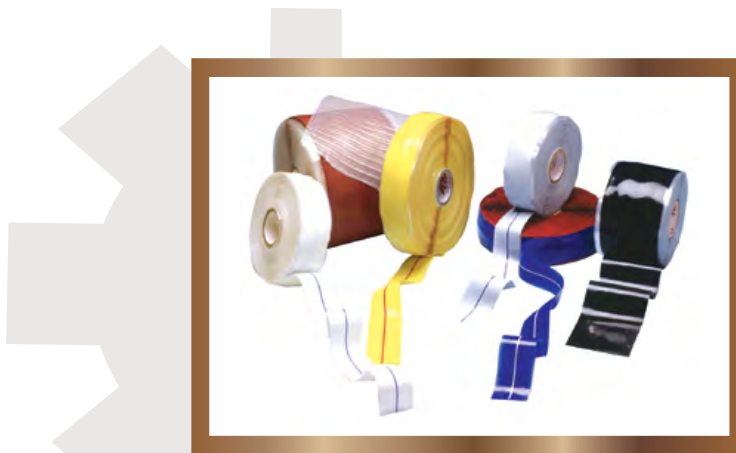

**Self-Fusing Silicone Tape**  
5-4 - 5-5



- Many different color choices!
- 0.012" thick x 1.0" wide x 10 yards long
- A low cost alternative to industry leading, silicone, self fusing tapes
- Resists moisture, oxygen, corona, and ozone exposure to assure continuous high insulation values
- Conforms smoothly when wrapped around complex forms.
- ROHS compliant
- Shelf Life is 5 years from the DOM when stored at 70° +/- 5°F and 50% RH
- Designed for continuous operation at 180°C



## ESTCO'S FUSE IT TAPE™ SILICONE SEALING TAPE

Get a tougher tape at a lower price.

Fuse It Tape™ is self-fusing silicone tape that can help you fix or seal just about anything in your life.

With a tensile strength of 1150 psi, you'll enjoy a superior, tougher tape that is up to 64% stronger than other brands.

Did we mention it's also priced lower than the other brands?

Repair, mend, and make the things in your life better.

With Fuse It Tape™, you can fix multiple things in your daily life. Make them tougher, stronger, better.



### Insulation

Easily fix electrical wires or stripped phone chargers.



### Patch

Mend low-pressure hoses: garden, car engines, etc.



### Repair

Pipes and plumbing leaks are easily fixed.



### Wrap

Protect tools and grips. Create easy cable wraps.

## ZERO MESS. ZERO ADHESIVE.

Duct tape, electrical tape and other tapes can all leave a sticky mess when removed.

Fuse It Tape™ leaves no mess whatsoever because there is no adhesive involved.

Even when removed years later, no sticky residue will be left over.

For more specs visit website: [fuseittape.com](http://fuseittape.com)

# FUSE IT TAPE™

[fuseittape.com](http://fuseittape.com)



ISO 9001 Certified  
CERTIFICATE # 08-511

# SFT - SILICONE, SELF-FUSING ELECTRICAL TAPE



## Arlon Silicone, Self-Fusing Electrical Tape® Tape

When looking for a silicone, self fusing tape, Arlon SFT is an affordable, easy to order, and highly functional, silicone, self-fusing tape. With over 30 years of in-service use in numerous highly demanding applications (such as aerospace and military) you can rely on Arlon SFT. The Arlon SFT product is gray in color and 0.012" thick x 1.0" wide x 10 yards long. The Arlon SFT product is lined with 0.001" thick x 1.1875" wide polyester liner and has electrical and mechanical properties that exceed most industry standards. By purchasing your silicone, self-fusing tape directly from ESTCO (Certified distributor of Arlon products) you will receive a high quality tape at an affordable price.

The typical properties table below can be used to compare Arlon SFT versus industry leaders like 3M™ Scotch® 70 tape:

- Gray
- 0.012" thick x 1.0" wide x 10 yards long
- A low cost alternative to industry leading, silicone, self fusing tapes
- Resists moisture, oxygen, corona, and ozone exposure to assure continuous high insulation values
- Conforms smoothly when wrapped around complex forms.
- ROHS compliant
- Shelf Life is 5 years from the DOM when stored at 70° +/- 5°F and 50% RH
- Designed for continuous operation at 180°C

Property	Arlon SFT	Test Method
Hardness (SAP)	50	ASTM D2240
Tensile Strength (psi)	1200	ASTM D412
Elongation (%)	612	ASTM D412
Dielectric Strength (VPM)	881	ASTM D149
Bond Strength (lbf/inch)	2.4	MIL-I-46852C / AA59163
Water Absorption (%wt)	0.38	MIL-I-46852C / AA59163





## SELF-FUSING SILICONE TAPES

Arlon and MOX-Tape® silicone tapes are produced from specially formulated silicone rubber. They bond irreversibly to provide an insulative barrier that is resistant to moisture, oxygen, ozone and corona over a wide temperature range (-65°F up to +500°F). Our products provide superior electrical insulation with a dielectric strength of 300VPM minimum at 356°F/180°C.

### PERFORMANCE ADVANTAGES

- Resists moisture, oxygen, and ozone to assure continuous high insulation values.
- Conforms smoothly when wrapped around complex forms.
- Bonds to itself at room temperature within 24 hours.
- Remains non-tacky to the touch and does not adhere to other surfaces, or substrates.
- Insulates with single wrap, thereby reducing labor time and cost.
- Dampens vibration and resists heat and mechanical shock as well as corona.
- Inherently flame retardant and when burned forms a non-conductive ash. Meets the horizontal burn test criteria prescribed in FAR 25.853.
- SA & SB MOX-Tapes® provide a uniform thickness even around sharp edges. Fiberglass fabric, encapsulated inside the silicone rubber, prevents wicking and maintains high insulation resistance under high humidity conditions. These controlled stretch tapes provide a uniform insulation barrier.
- All tapes are protected by a special interleaved liner.

### TYPICAL PROPERTIES

Thermal Stability .....	356°F/180°C
Temperature Range ....	-65°F to +500°F (-50°C to +260°C)
Volume Resistivity .....	1013 ohm-cm min. (ASTM D257)
Self Adhesion .....	2 p.p.i min. (ASTMD2148)
Hardness .....	50±10 Shore A (ASTM D2240)
Moisture Absorption ....	0.9% (46 hrs. in H <sub>2</sub> O @ 70°F)

*NOTE: The above properties are published as a guide only, and should not be used for specifications without testing in your own laboratory.*

### APPLICATIONS

#### Mechanical:

- Protection of coils from vibration.
- Vibration fixture, anti-scratch, and clamping pads.
- Harness wrapping and wire bundling, including for high temperature applications.
- Applied to rollers for protection and traction.
- Plant maintenance.
- Superior, heavy duty repair tape for emergency insulating barrier.

#### Electrical:

- Insulation of field armature and interpole coils in large motors.
- Insulation for splicing and terminating of wire and cable.
- Insulating and sealing electrical connections.
- Insulating coil leads and bus bar connections.
- Electromagnetic coil insulation.
- Motor connections.
- Overwrapping of deteriorated insulation in reclaimed motors.

#### Environmental:

- On-board aviation and space applications.
- Underground cable splices.
- Insulating heated transfer lines.
- Insulating in radioactive environments.
- Masking agent utilized in manufacturing processes and powder coatings.
- Insulating, protecting, and sealing rigging hardware and power systems in marine applications.



ISO 9001 Certified  
CERTIFICATE # 08-511

# SELF-FUSING SILICONE TAPES CONTINUED...



## Arlon LevelWrap® Tape



Levelwrap® has tapered edges and a colored line along its apex. The purpose of the line is to act as a guide for subsequent wraps in order to form a uniformly thick layer. MOX-Tape® 600-T series triangular unsupported tapes, which also meet various military and aerospace specifications, are also available.

**LW** - - - - - Example: LW401R12-P0

1 for Mil Spec testing. 0 if not  
 Liner Type. Polyethylene or Mylar  
 Length in Yards  
 Color. Red, Black, White or Grey (X)  
 Width in inches. Can be one to three digits.  
 For example 125 for 1 1/4" wide tape or  
 2 for 2" wide. Available in 0.5" to 2" wide.  
 Thickness in mils. Available in 10 to 80 mils thick  
 Designates triangular Tape

## Rectangular 600-R AND Triangular 600-T Series Tape



Rectangular tape is of uniform thickness and is ideal for applications where a smooth, even layer of tape is not required. Triangular tape has a center guideline for even wrapping. Arlon's MOX-Tape 600-R Rectangular and 600-T Triangular Series unsupported tapes meet various military and aerospace specifications.

**9** - - - - - Example: 920-10R12-P0

1 for Mil Spec testing. 0 if not  
 Liner Type. Polyethylene or Mylar  
 Length in Yards  
 Color. Red, Black, White or Grey (X)  
 Width in inches. For example 125 for 1 1/4" wide tape.  
 Available in 0.5" to 2" wide.  
 Thickness in mils. Available in 10 to 80 mils thick  
 Designates Rectangular Tape

## Arlon MOX-Tape® Fiberglass Reinforced Tape

These self-fusing silicone rubber tapes incorporate a sinusoidal fiberglass fabric that gives a controlled elongation and increased tear resistance. The SA series has a maximum elongation of 25% and the SB series has a maximum elongation of 15%. This reinforcement provides excellent mechanical characteristics while allowing the tape to conform to irregular shapes. The table below lists a few examples of reinforced tapes that are available.

**ST** - - - - - Example: ST-620-1 R

Color. Red, Black  
 Width in inches. Can be one to two digits.  
 For example 05 for 1/2" wide tape or  
 1 for 1" wide. Available in 0.5" to 1.5" wide.  
 Cross Section: 600 - 607 for triangular  
 cross-section with colored guidelines.  
 612 - 630 for rectangular cross-section  
 Silicone Tape

ESTCO Enterprises, Inc. Standard Part No.	Thickness (inches)	Width (inches)	Elongation (%)	Break Strength (lbs)
ST-SA00520	0.02	1/2	25	40
ST-SB00520	0.02	1/2	15	40
ST-SA01015	0.015	1	25	40
ST-SB01015	0.015	1	15	40
ST-SA03030	0.03	3	25	40
ST-SB03030	0.03	3	15	40

## CERTIFICATIONS

- Tapes are manufactured under ISO 9001 certification. Products can also be certified to many of the following specifications upon request.
- MIL-I-46852C, Type I & Type II
- General Electric A50A493
- A-A-59163, Type I & Type II
- General Electric A50E112
- MIL-1-22444C
- General Dynamics P5384
- Boeing DMS2186 Type 1 & Type 2 & 3
- Rohr RMS315
- Lockheed Martin MMS J517
- FAR 25.853
- Lockheed Martin 5-00857
- UL listed



## SPECIALTY & MISC. ITEMS



**SunScreener Wire Mesh Clip**  
6-2

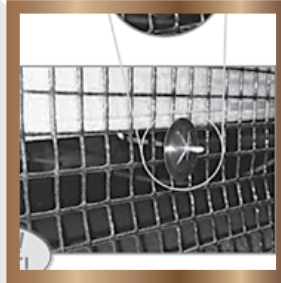

**SunScreener Wire Mesh**  
6-3

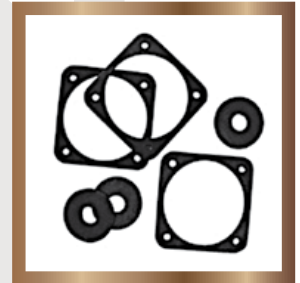

**Gaskets**  
6-4 - 6-5

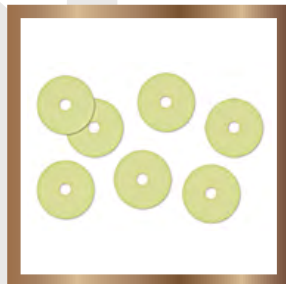

**Latex Free Diaphragms**  
6-6

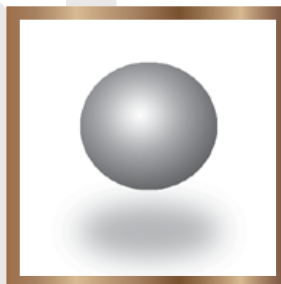

**Solid Round Balls**  
6-7



**Extrusions & Lathe Cuts**  
6-8 - 6-9



**WELL NUT®  
Metric Threaded Inserts**  
6-10



**WELL NUT®  
Inch Threaded Inserts**  
6-11



# SUNSCREENER WIRE MESH CLIP



- Helps protect solar panels from rodents and nesting birds with wire mesh screening (screening not included). See Estco Sunscreen below.
- Constructed from 303 and 304 Stainless Steel for maximum endurance to outdoor elements.
- 303 Stainless Steel J-Hook easily attaches to the solar panel frames.
- 304 Stainless Steel Washers will firmly hold wire mesh screen to the module assembly preventing squirrels and rodents from damaging the interconnection wires and birds from building nests under the solar panel.
- Does not violate panel integrity.
- The Stainless Steel J-Hook can easily be trimmed or bent after assembly.
- Installs quickly and easily with standard linesman pliers
- Black color available for those applications subject to HOA appearance restrictions.
- Stainless Steel Washers are offered in both steel color and black painted versions.
- Not for use in a marine salt water environment.

PART NO.	PART DIMENSIONS CLIP DIMENSIONS									
	A Overall Length		B Diameter		C Width		D Height		E Washer Diameter	
	in.	mm.	in.	mm.	in.	mm.	in.	mm.	in.	mm.
H-S6437 H-S6438	4.87	124,0	.08	2,0	.38	9,7	.38	9,7	1.00	25,4

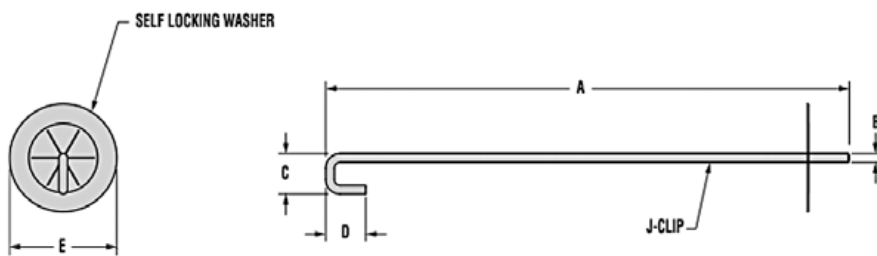

PART NO.	PART DIMENSIONS	
	Width in.	Length feet
S6464	4	100'
S6466	6	Rolls
S6468	8	Rolls

Quick  
Specs



<b>Material</b>		<b>SunScreener Wire Mesh Clip</b>
	J-Hook	303 Stainless steel
	Washer	304 Stainless steel

# SUNSCREEN

Wire Mesh - For use with ESTCO SunScreener Clips

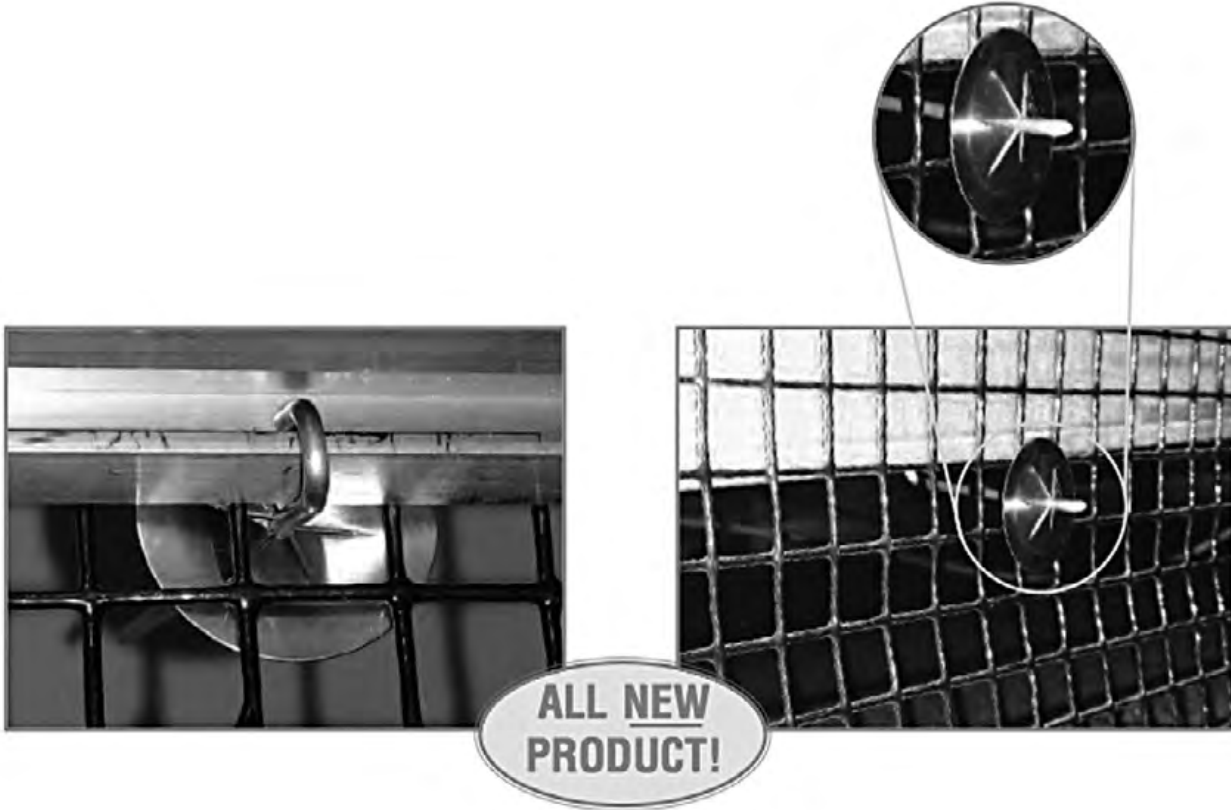

Material

SunScreen Wire Mesh  
PVC Coated, galvanized welded  
steel mesh

*Quick  
Specs*

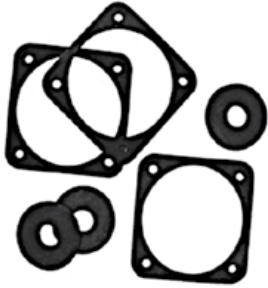

- Nitrile, Butyl, Epdm, Gum Rubber, Neoprene, Viton, Cloth Inserted, Rubber, Silicone, Nylon, Polyethylene, Polypropylene, Styrene, Santoprene, Vyram, Geoflast, Teflon.
- Custom gaskets available.
- ESTCO has thousands of gasket models in-stock. We also provide custom gaskets made to fit to your specification.
- Provide us with your print, material specs and quantities and we'd be happy to quote.



## GASKETS

Part Number	Part Name or Description
1/2 ID X 1" OD"	3/16 CUT WHTSIL WASHER (707)"
10212	LATEX FLUTTER VALVE LARGE
10213	LATEX FLUTTER VALVE SMALL
10714	LG FLUTTER VALVE LATEX FREE RE
10733	SMFLUTTER VALVE LATEX FREE REV
10734	DIAPHRAGM VALVE LATEX FREE
10754	DIAPHRAGM FLUTTER LATEX FREE R
20-0220	GASKET GAS-200220 SMALL CHEC K
60172	LARGE FLAPPER VALVE LATEX-FREE
60173	SMALL FLAPPER VALVE LATEX FREE
60686	LARGE FLAPPER LATEX FREE
90799-48F-WE	DIAPHRAGM ID.041 OD.440 TK.0 14
9714-95012	SEALING GASKET 50DURO GREY E PD
CR7600018	DIAPHRAGM VALVE ZEON POLYISO PR
FORMEX .018	24 X 48" FORMEX .018SHEETS"
G-1000	WASHER .197X.886X.189 70 NEO
G-1010	.375OD X .080X2ID X .187 CCN S
G-1014-A	FOAM ADHESIVE NEOPRENE GASKET
G-1018	1.50 x 2.00 RECTANGLE ADHESIVE
G-1019	40 NEO 3OD 1/2"ID 1/8" THICK
G-1019-1	GASKET 1/2IDX3ODX1/8 BUNA-NW HT
G-1020-1	GASKET 5/8IDX4ODX1/8 BUNAN W HT
G-1036	GASKET WASHER 9/16X1/16
G-1042	4.65 OD .375ID .125CUT WHITE
G-1043	WASHER .157IDX.500ODX.157THK
G-1044	50-8728-A REV .094 CCNS W/PSA
G-1045	12.150X.280X3/16 50-8730-1
G-1046	8.8X.280X.187 50-8730-2 REV X3
G-1047	.600 X .094 CC/PSA50-8728-2 X2
G-1048	.600X.280X3/16<50-30120-1 RX1
G-1049	12244 SPEC REV. 01/DWG REV.A
G-1051	CHASSIS GASKET 7.75 #90003-1
G-10516 W/PSA	1-1/2 X .062 CCNS W/PSA
G-1052	3.00 DIA W/3 HOLES #22009-10 0
G-1053	CABLE CLAMP 50-30169 REV X6 PK
G-1055	1-1/8 ID 3-1/2 LENGTH 2-3/8 WI
G-1056	PH-182 1 1/4OD X .312ID X1/8" GASK
G-1058	PH-185 (.875X.312X.125) PSA
G-1059	PH-186 (.875X.312X.250)
G-1060	PH-187 (1.125X.312X.375 W/PS A)
G-1061	PAD 2x5x1/2 HK-3/4 HOLE 60NE O"
G-1066	CUSTOM PART 1/16 CCNS W/PSA RH
G-1066A	CUSTOM PART CCNS 1/16 W/PSA LH
G-1070	01855 CABLE CCNS W/PSA 1/16 "
G-1070-A	01856 LG PLUG CCNS W/PSA 1/P SA
G-1070-B	01857 SM PLUG CCNS W/PSA1/16" GASK
G-1071	1.75ODX.250" NEO 50 PN 608
G-1071-A	2 Disk x 3/16" Neoprene 50Sh"



ISO 9001 Certified  
 CERTIFICATE # 08-511

# GASKETS



Part Number	Part Name or Description
G-1072	1.00 X .250 NEOPRENE DISK*
G-1081	2 1/4 x 1 1/4 x 1/8" Neow/PS*
G-1085	3/4 OD X 1/4 ID X 3/16 CUT 60 N
G-1091	1.75OD X 1.625"ID x .03 1 Cut*
G-1101	.88 OD x .25 ID x .062 Thick
G-1110	.400 DISK CCNS W/PSA KISS CU T
G-1150	.600 OD X .185 ID X .250 EPD M
G-1200	1.2 LENGTH X .560 WIDTH W/.2 6"
G-1325	5 OD X .125 ID .300 HOLES (8 )*
G-1350	.375 X .187 DISK OPEN CELL W /P
G-1351	SPACER 22-39430-000
G-1352	GASKET .955ODX.540IDX.150THK N
G-1353	GASKET MYLAR .005TH 1/4ID X 1"
G-1354	GASKET PER GA00272ABA
G-1355	GASKET #GA00273 ABA
G-1356	GASKET .453 OD X 1/8 THK SIL I"
G-1357	GASKET 60 NEO CH #900-025
G-1358	GASKET 60 NEO CH #900-026
G-1359	GASKET .915 OD X 1/8" T HKSIL*
G-1360	GASKET SILICONE BLK #900-029
G-1361	GASKET 70 SILICONE CH#900-02 4
G-1362 BLACK	.31ID X 1.00D X .12 THK 80 E PD
G-1363	GASKET SILICONE CH# 900-028
G-1364	GASKET SILICONE CH# 900-027
G-1365	GASKET 1.375IDX1.855ODX.032T H
G-1366	GASKET 1.267IDX1.855ODX.032T H
G-1367	.650 OD x .125" THK NEO PRENE*
G-1368	.650 OD x .3/32" THK EP DM
G-1369	CCPOLY FOAM W/ADHES 6WDX25"L O*
G-1370	GASKET CCNS WITH PSA KISS-CU T
G-1371	GASKET, FLAT MOUNT WIPER1.78" GASK*
G-1373	GASKET W/ 4 HOLES 2.05 X2.05
G-1374	CRYSTAL GASKET
G-1375	GASKET CCNS W/ PSA KISS CUT
G-1376	3/16X1/2" CCNS W/ PSA "
G-1377	GASKET REAR 40A BLK SILICONE .
G-1378	BOTTOM GASKET 40A BLK SILICON E
G-1379	FRONT GASKET 40A BLK SILICON E
G-1380	WASHER .3125ID X 1.375OD X . 12
G-1381	3/8ID X 7/8"OD X 1/16"THKDIE"
G-1382	.1875 ID x 1" OD x .125 "THK"
G-1385	GASKET .375IDX.875ODX.250THK 6
G-1386	FUNNEL GASKET BLACK BUNA FDA 5
G-1387	3.5 X 3.5" X .500" THK NEOPAD*
GS-1050	.250 CCNS SPONGE CORD MED DE N
GS-1200	1/16 x 1.00 CCNS W/PSA<"
GS-1250	1/16 x 1-1/2 CCNS W/PSA 50" "
GS-1377	WASHER, SILICONE BUMPER W/PS A

- Nitrile, Butyl, Epdm, Gum Rubber, Neoprene, Viton, Cloth Inserted, Rubber, Silicone, Nylon, Polyethylene, Polypropylene, Styrene, Santoprene, Vyram, Geoflast, Teflon.
- Custom gaskets available.
- ESTCO has thousands of gasket models in-stock. We also provide custom gaskets made to fit to your specification.
- Provide us with your print, material specs and quantities and we'd be happy to quote.



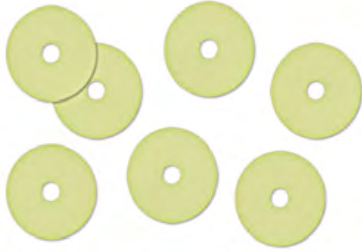

## LATEX FREE DIAPHRAGMS

ALL SIZES MADE TO CUSTOMER  
SPECIFIED REQUIREMENTS & TO PRINT

- Made from Non-Allergenic, Latex-Free materials.
- ESTCO is a leading distributor of latex-free diaphragms of all types, shapes and sizes. In addition to standard model numbers, we also provide custom diaphragms.
- Save money on higher-quality,
- ISO-compliant parts.
- Contact us at 888-696-7826



ISO 9001 Certified  
CERTIFICATE # 08-511



## SOLID ROUND BALLS

These molds are made to commercial tolerances and will have flash around the parting line of balls.

Precision, or flashless balls, are also available in various sizes and materials. These balls are OD ground which eliminates any flash or parting line and can result in TiR tolerances of  $\pm.003$ . Higher production volumes are required on flashless balls as a result of the set-up of special equipment.

PART NO.	A		
	Inch	Dec	MM
E-664	1/8	0.125	3.2
E-665	1/4	0.250	6.4
E-2993	3/8	0.375	9.5
E-2636	7/16	0.438	11.1
E-656	1/2	0.500	12.7
E-659	3/4	0.750	19.1



ISO 9001 Certified  
CERTIFICATE # 08-511

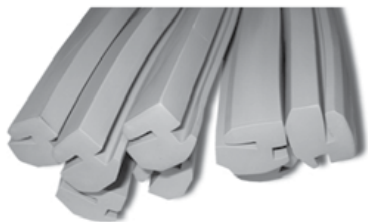

## EXTRUSIONS & LATHE CUTS

Standard off-the-shelf parts don't always work. From spec to the final product, ESTCO has provided thousands of custom extruded parts for industrial use: automotive, medical, marine, toy, hardware, and many other industries.

### UNIQUE EXTRUSION PROGRAM:

Our unique extrusion program allows runs down to 100 feet using our in house 70 durometer EPDM compounds. Send us your print or profile sketch and we will respond within 48 hours.

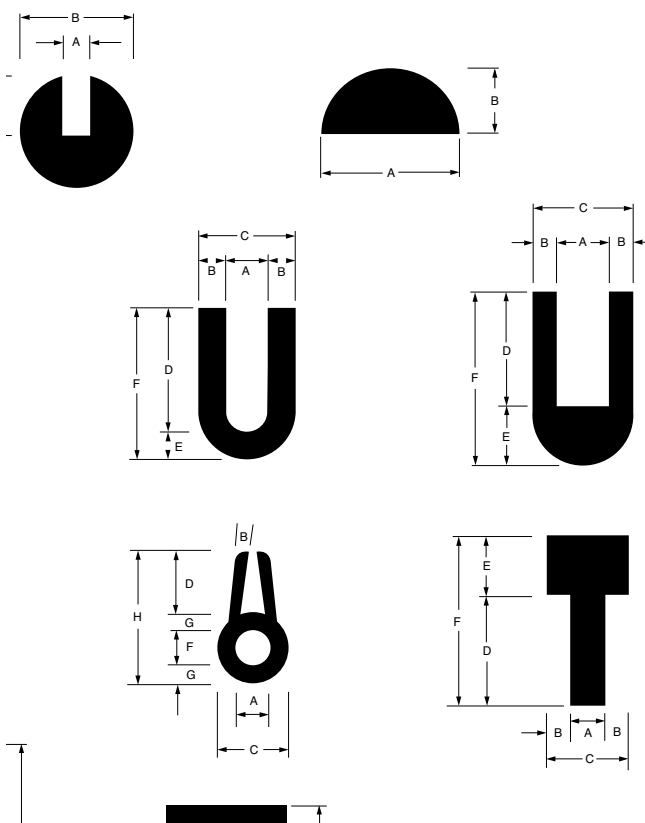

Extruded materials include all organic compounds listed in this book as well as non-organics such as silicones. Cellular extrusions are also available as special runs.

**CALL FOR SIZES**



ISO 9001 Certified  
 CERTIFICATE # 08-511

# EXTRUSIONS & LATHE CUTS

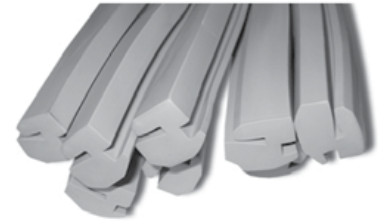

## RUBBER LATHE CUTS

### What is a Lathe Cut?

A lathe cut product is manufactured from a cylindrical tube of rubber by inserting a mandrel into the cylindrical tube and cutting the finished dimensions with a knife while the mandrel is being turned at high speed in a lathe type machine.

### Uses

Lathe cut products are used in many applications such as: Seals, Drive Belts, Vibration Dampeners, Bumpers, Bushings and Insulators.

### Method of Manufacture

The cylindrical tube from which lathe cut products are cut may be produced by several manufacturing processes depending on design parameters such as size, quantity required, tolerances and material.

### Capability

We can custom manufacture Lathe Cut Washers and Gaskets for tight tolerance applications for a wide range of markets. We can produce diameters from 1/8" to 7" ID, cut thickness starting at .020" with tolerances of plus/minus .004 with durometer ranges from 40 to 90, shore A.

### Compounds

Our extensive applications experience provides you with custom compounds that respond to your need for the most cost effective materials. Our formulas use ASTM specifications and the most demanding performance testing criteria. We can offer a wide range of custom or stock compounds in Nitrile, Neoprene, EPDM, SBR, Silicone, Fluoro-elastomer, Natural Rubber and some food and water grade formulas.

Standard off-the-shelf parts don't always work. From spec to the final product, ESTCO has provided thousands of custom extruded parts for industrial use: automotive, medical, marine, toy, hardware, and many other industries

VARIOUS CROSS SECTIONS ARE AVAILABLE FOR LATHE CUT PARTS AS SHOWN BELOW.

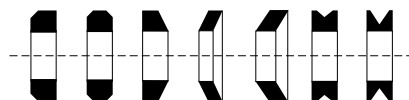
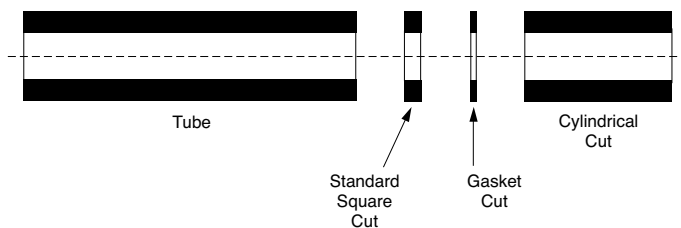

SAMPLE ANGLE CUTS







# WELL NUT®

## Metric Threaded Inserts

### • Standard and Snap-In Well Nut Installation

1. Place WELL NUT Insert all the way into predrilled hole until flange is firmly against mounting surface.
2. Pass machine screw through part to be fastened.
3. Tighten until snug.

**Dimensions & Specifications (Metric)**

**Test Results @ Plate Thickness (T)**

Catalog Number	Part Number	Thread Size	Body Diameter D	Hole Size nom	Grip Range min - max	Length L	Head Height HH	Head Diameter HD	Snap Diameter SD	Plate Thickness mm	Tightening Torque N-m	Ultimate Tensile N
<b>STANDARD</b>												
C632	347017	M3 x 0.5	6.10	6.35	9.53 - 15.42	24.92	0.89	14.07	--	12.7	0.34	512
E632	347043	M3 x 0.5	7.92	7.92	0.38 - 3.96	12.67	1.57	11.48	--	1.57	0.45	507
B632	347011	M4 x 0.7	7.92	7.92	0.38 - 3.96	12.67	1.32	11.13	--	1.57	0.34	649
C832*	347026	M4 x 0.7	6.10	7.92	0.38 - 4.37	14.22	1.52	19.05	--	1.60	0.34	578
L1024*	347089	M5 x 0.8	9.53	9.53	0.76 - 5.77	19.48	4.75	14.27	--	3.18	0.56	423
10S	347107	M5 x 0.8	9.58	9.58	0.38 - 4.88	14.07	0.91	12.70	--	3.18	0.56	1023
10SL	347111	M5 x 0.8	9.53	9.53	7.92 - 16.33	26.70	1.30	14.27	--	12.7	0.34	1401
10XL*	347141	M5 x 0.8	9.53	9.53	20.62 - 29.03	39.40	1.30	14.27	--	26.67	1.13	1650
G1032	347049	M5 x 0.8	9.58	9.58	0.76 - 5.77	20.50	4.75	19.05	--	3.18	0.56	1232
H1032	347051	M5 x 0.8	9.58	9.58	7.92 - 11.43	21.51	0.89	14.07	--	9.53	0.34	1156
J1032	347063	M5 x 0.8	9.58	9.58	0.76 - 5.77	17.78	2.03	19.05	--	3.18	0.56	1001
Q1032	347087	M5 x 0.8	9.58	9.58	0.89 - 5.89	16.89	1.02	14.27	--	3.18	0.56	1179
HSCM6X1	347261	M6 x 1.0	12.50	12.70	0.38 - 2.39	16.00	1.52	14.73	--	1.91	1.13	1001
EM6X1*	347247*	M6 x 1.0	12.50	12.70	0.38 - 2.39	16.00	1.30	17.25	--	0.79	1.58	534
ACM6X1*	347256*	M6 x 1.0	12.50	12.70	0.38 - 1.57	16.00	1.30	19.99	--	1.57	1.13	1308
1/4A*	347256	M6 x 1.0	12.70	12.70	0.38 - 1.27	15.98	2.82	15.98	--	1.91	1.13	1290
1/4S	347103	M6 x 1.0	12.70	12.70	0.38 - 2.82	16.00	1.30	16.00	--	1.91	1.13	1023
D1420	347031	M6 x 1.0	12.70	12.70	0.79 - 4.75	21.06	4.75	18.80	--	4.75	1.69	1245
J1420	347067	M6 x 1.0	12.70	12.70	6.35 - 11.61	26.70	1.30	16.13	--	6.35	1.13	1979
M6X1*	347254*	M6 x 1.0	12.70	12.70	0.38 - 2.39	16.00	1.30	19.99	--	1.91	1.13	992
MDM6X1*	347248	M6 x 1.0	12.70	12.70	0.79 - 4.75	21.06	4.75	18.80	--	4.75	1.69	1379
W1420	347093	M6 x 1.0	12.70	12.70	4.75 - 8.71	20.35	1.30	16.13	--	4.75	1.13	1601
E51618	347035	M8 x 1.25	15.88	15.88	0.38 - 3.96	18.42	3.18	22.23	--	3.84	2.82	2033
F51618*	347470	M8 x 1.25	15.75	15.88	3.96 - 9.53	27.94	5.71	22.22	--	9.53	1.69	2482
A51618*	347252	M8 x 1.25	19.00	19.05	0.38 - 6.02	27.00	5.00	32.00	--	4.75	2.26	1962
A3816*	347009	M8 x 1.25	19.05	19.05	0.38 - 11.10	26.97	4.75	31.75	--	11.10	2.26	6672
<b>SNAP-IN</b>												
2D832*	347027	M4 x 0.7	7.87	7.92	0.38 - 1.27	10.92	1.27	12.70	9.53	0.79	0.56	405
A1024*	347006	M5 x 0.8	9.53	9.53	0.38 - 1.27	14.27	3.18	14.27	10.34	0.79	0.56	694
NP1032	347266	M5 x 0.8	9.53	9.53	0.38 - 1.27	10.16	1.50	12.95	10.34	1.27	0.56	1023
W0811JS*	347410	M6 x 1.0	12.47	12.47	0.76 - 5.77	17.53	2.82	16.00	13.47	3.18	0.56	1023
ET51618*	347360	M8 x 1.25	15.88	15.88	0.38 - 3.00	27.99	8.48	22.20	17.25	3.18	0.9	1717

\*Requires 25,000 minimum order. \*\*Refer to factory. • Material is EPDM

**Specifications**

Body Material: Chloroprene and EPDM  
 Nut Material: Brass  
 Thread Class: 2B (in); 6H (mm)

**Standard Type   Snap-In Type   Installed   Torque   Tensile**

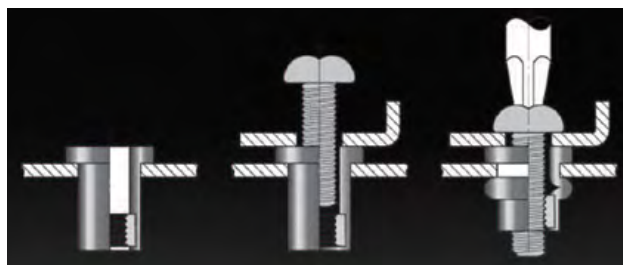
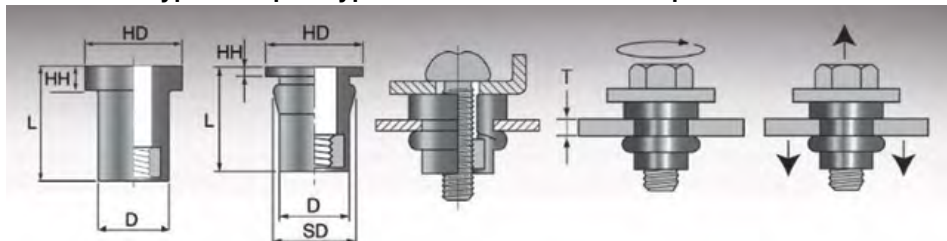

# WELL NUT®

## Inch Threaded Inserts



### Dimensions & Specifications (Inch)

### Test Results @ Plate Thickness (T)

Catalog Number	Part Number	Thread Size	Body Diameter D	Hole Size nom	Grip Range min-max	Length L	Head Height HH	Head Diameter HD	Snap Diameter SD	Plate Thickness in	Tightening Torque in-lb	Ultimate Tensile lb
<b>STANDARD</b>												
C632	347024	6-32	0.240	0.250	0.375 - 0.607	0.981	0.035	0.554	-	0.500	3	115
E632	347042	6-32	0.312	0.312	0.015 - 0.156	0.499	0.062	0.452	-	0.062	4	114
B832	347012	8-32	0.312	0.312	0.015 - 0.156	0.499	0.052	0.438	-	0.062	3	146
C832*	347025	8-32	0.312	0.312	0.015 - 0.172	0.560	0.060	0.750	-	0.063	3	130
L1024*	347233	10-24	0.375	0.375	0.030 - 0.277	0.767	0.187	0.562	-	0.125	5	95
10S	347108	10-32	0.377	0.377	0.015 - 0.192	0.554	0.036	0.500	-	0.125	5	230
10SL	347112	10-32	0.375	0.375	0.312 - 0.643	1.051	0.051	0.562	-	0.500	3	315
10XL*	347198	10-32	0.375	0.375	0.812 - 1.143	1.551	0.051	0.562	-	1.050	10	371
G1032	347048	10-32	0.377	0.377	0.030 - 0.227	0.807	0.187	0.750	-	0.125	5	277
H1032	347054	10-32	0.377	0.377	0.312 - 0.450	0.847	0.035	0.554	-	0.375	3	260
J1032	347064	10-32	0.377	0.377	0.030 - 0.227	0.700	0.080	0.750	-	0.125	5	225
Q1032	347088	10-32	0.377	0.377	0.035 - 0.232	0.665	0.040	0.562	-	0.125	5	265
1/4S	347102	1/4-20	0.500	0.500	0.015 - 0.111	0.630	0.051	0.630	-	0.075	10	230
D1420	347030	1/4-20	0.500	0.500	0.031 - 0.187	0.829	0.187	0.740	-	0.187	15	280
J1420	347068	1/4-20	0.500	0.500	0.250 - 0.457	1.051	0.051	0.635	-	0.250	10	140
JL1420	347355	1/4-20	0.500	0.500	0.625 - 0.830	1.432	0.422	0.625	-	0.375	10	445
JM1420*	347440	1/4-20	0.500	0.500	0.215 - 0.422	1.440	0.440	0.650	-	0.250	10	445
W1420	347095	1/4-20	0.500	0.500	0.197 - 0.342	0.801	0.051	0.635	-	0.187	10	360
AC1420*	347000	1/4-20	0.562	0.562	0.280 - 0.500	1.301	0.051	0.635	-	0.397	20	251
E51618	347034	5/16-18	0.620	0.625	0.015 - 0.156	0.725	0.125	0.875	-	0.151	25	457
F51618*	347033	5/16-18	0.620	0.625	0.156 - 0.375	1.100	0.225	0.875	-	0.375	15	558
A3816	347008	3/8-16	0.750	0.750	0.015 - 0.437	1.062	0.187	1.250	-	0.437	20	1500
Z3816*	347098	3/8-16	0.750	0.750	0.015 - 0.125	1.050	0.350	1.750	-	0.125	30	1125
<b>SNAP-IN</b>												
2D832*	347029	8-32	0.310	0.312	0.015 - 0.050	0.430	0.050	0.500	0.375	0.031	5	91
A1024*	347004	10-24	0.375	0.375	0.015 - 0.050	0.562	0.125	0.562	0.407	0.031	5	156
NP1032	347280	10-32	0.375	0.375	0.015 - 0.050	0.400	0.059	0.510	0.407	0.050	5	230

\*Requires 25,000 minimum order.

### • WELL NUT®

The WELL NUT is a flat head round body rubber blind rivet nut that is installed when the mating screw is tightened. The WELL NUT is available in Chloroprene for standard applications and EPDM when exposed to sunlight and ultra violet rays. The internal threads are made of brass. WELL NUT inserts are RoHS compliant.

### WELL NUT advantages:

- Seals out ambient moisture
- Muffles noise
- Dampens vibrations and shock
- Isolates electrical conductivity
- Isolates galvanic corrosion between dissimilar assembled components
- Snap in version can be pre-attached to parent material
- Available in custom materials to meet specific application requirements

### Standard Type    Snap-In Type    Installed    Torque    Tensile

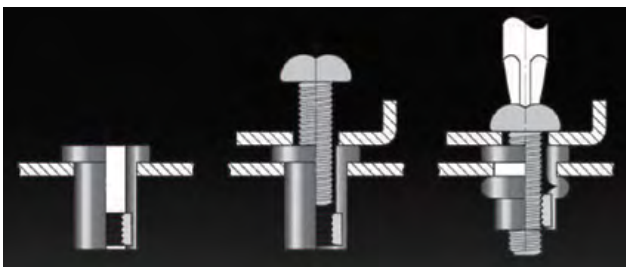
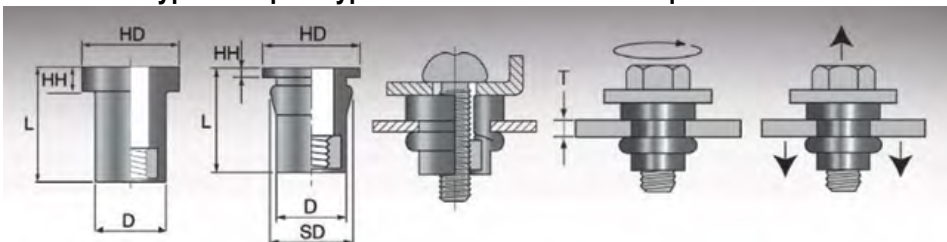

### Specifications

Body Material:	Chloroprene and EPDM
Nut Material:	Brass
Thread Class:	2B (in); 6H (mm)



ISO 9001:2000 Certified  
CERTIFICATE # 08-511

# VIBRATION & SHOCK MOUNTS



**Series 300 Cylindrical Mountings**  
7-2 - 7-18



**Series 540 Rectangular Mountings**  
7-19



**Series 600 Heavy-Duty Center-Bolt Safety Mountings**  
7-20 - 7-24



**Series 1000 Custom Molded Mounting Feet**  
7-25



**Series 5000 Bonded Bushing and Snubber**  
7-26



**Series 9000 Cylindrical Mounting Pads**  
7-27 - 7-29



### SERIES 300 CYLINDRICAL MOUNTINGS

Styles: **MM300/317**

For loads to 79 pounds in compression; 40 pounds in shear

- The small, yet rugged design and the broad range of sizes make ESTCO cylindrical mountings ideal for a wide range of applications. They have been used on electric motors and generators, fans and blowers, relays and control panels, business machines timing devices and air handling equipment. ESTCO cylindrical mountings can be loaded in compression, in shear, or in combination compression and shear. Additional standard stud combinations have been added to the line to allow wider applications of these mountings to a customer's design requirements. All engineering data herein apply to mountings with a studed or tapped insert at each end. The maximum unthreaded portion of the stud does not exceed 1/16-inch.

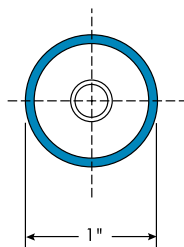
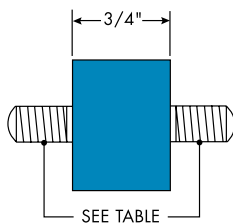

#### SELECTION GUIDE

COMPRESSION		MINIMUM LOAD FOR 81% ISOLATION (LBS)									
LOAD RATING	MAXIMUM LOAD (LBS)	FORCING FREQUENCY IN CYCLES PER MINUTE									
		850	1100	1250	1500	1750	2000	2250	2500	3000	3600
A	33				29	21	16	12.5	10.5	7.0	5.0
B	40				39.5	28.5	21.5	17.0	14.0	9.5	7.0
C	60					49	37	29.5	24.0	17.0	11.5
D	79					72.5	55	43.5	36	24.5	17.0

SHEAR		MINIMUM LOAD FOR 81% ISOLATION (LBS)									
LOAD RATING	MAXIMUM LOAD (LBS)	FORCING FREQUENCY IN CYCLES PER MINUTE									
		850	1100	1250	1500	1750	2000	2250	2500	3000	3600
A	18	16.0	9.3	7.2	5.0	3.8	2.8	2.3	1.8	1.2	*
B	21		13.0	10.2	7.0	5.3	4.0	3.2	2.6	1.8	*
C	34		24.5	20	14.7	11.2	9.0	7.5	6.2	4.5	3.5
D	40		32	26	19.0	14.8	12.0	10.0	8.3	6.0	5.0

\* At these forcing frequencies lesser loads will yield 81% isolation.

#### DIMENSIONS

LEFT STUD (IN.)		RIGHT STUD (IN.)		SUFFIX
THREAD	LENGTH	THREAD	LENGTH	
1/4 - 20	1/4	1/4 - 20	1/4	52
1/4 - 20	1/2	1/4 - 20	*	59
1/4 - 20	1/2	1/4 - 20	13/32	57
1/4 - 20	1/2	1/4 - 20	1/2	* 58
1/4 - 20	1/2	1/4 - 20	5/8	43
1/4 - 20	1/2	1/4 - 20	3/4	45
1/4 - 20	1/2	1/4 - 20	1	55
1/4 - 20	5/8	1/4 - 20	5/8	42
5/16 - 18	9/16	5/16 - 18	9/16	* 76

(Style #317)

\* standard stud \* tapped hole

#### LOAD DEFLECTION GRAPH

Deflections below the line X---X are considered safe practice for static loads; data above that line are useful for calculating deflections under dynamic loads

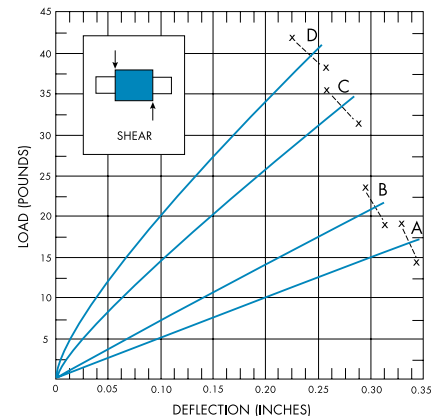
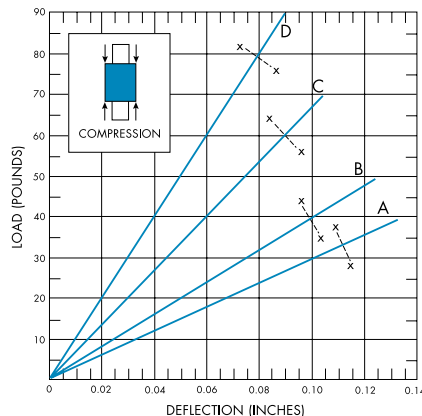

# SERIES 300 CYLINDRICAL MOUNTINGS

Style: **MM301**

For loads to 25 pounds in compression; 12.5 pounds in shear



## SELECTION GUIDE

COMPRESSION		MINIMUM LOAD FOR 81% ISOLATION (LBS)									
LOAD RATING	MAXIMUM LOAD (LBS)	FORCING FREQUENCY IN CYCLES PER MINUTE									
		1100	1250	1500	1750	2000	2250	2500	2750	3000	3600
A	8					6.2	4.8	4.0	3.2	2.7	2.0
B	12					10.2	8.0	6.5	5.4	4.5	3.2
C	16							14.0	11.6	9.6	6.8
D	25							22.0	18.2	15.2	10.4

SHEAR		MINIMUM LOAD FOR 81% ISOLATION (LBS)									
LOAD RATING	MAXIMUM LOAD (LBS)	FORCING FREQUENCY IN CYCLES PER MINUTE									
		1100	1250	1500	1750	2000	2250	2500	2750	3000	3600
A	4.4	4.0	3.1	2.2	1.7	1.3	*	*	*	*	*
B	6.7	6.5	5.2	3.7	2.8	2.3	1.8	*	*	*	*
C	9.0		9.0	6.3	4.6	3.6	2.9	2.3	1.9	*	*
D	12.5			11.2	8.2	6.3	5.1	4.0	3.3	2.8	2.0

\* At these forcing frequencies lesser loads will yield 81% isolation.

## DIMENSIONS

LEFT STUD (IN.)		RIGHT STUD (IN.)		SUFFIX
THREAD	LENGTH	THREAD	LENGTH	
8-32	1/4	8-32	*	19
8-32	1/4	8-32	1/4	12
8-32	1/4	8-32	3/8	15
8-32	3/8	8-32	*	13
8-32	3/8	8-32	3/8	• 10

• standard stud \* tapped hole

## LOAD DEFLECTION GRAPH

Deflections below the line X---X are considered safe practice for static loads; data above that line are useful for calculating deflections under dynamic loads

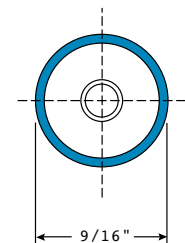
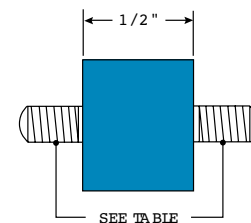
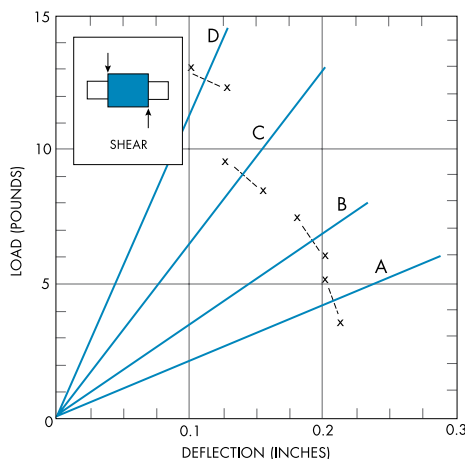
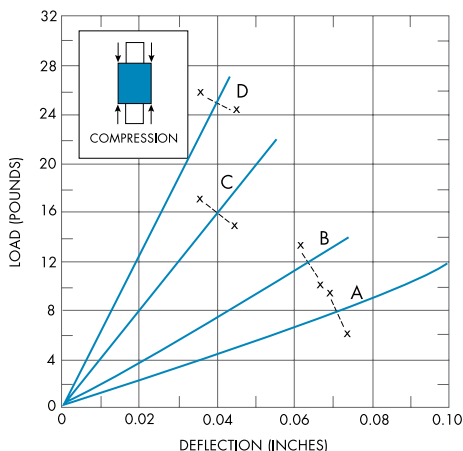

- The small, yet rugged design and the broad range of sizes make ESTCO cylindrical mountings ideal for a wide range of applications. They have been used on electric motors and generators, fans and blowers, relays and control panels, business machines timing devices and air handling equipment. ESTCO cylindrical mountings can be loaded in compression, in shear, or in combination compression and shear. Additional standard stud combinations have been added to the line to allow wider applications of these mountings to a customer's design requirements. All engineering data herein apply to mountings with a studded or tapped insert at each end. The maximum unthreaded portion of the stud does not exceed 1/16-inch.



## SERIES 300 CYLINDRICAL MOUNTINGS

Style: **MM302**

For loads to 13.3 pounds in compression; 6.4 pounds in shear

- The small, yet rugged design and the broad range of sizes make ESTCO cylindrical mountings ideal for a wide range of applications. They have been used on electric motors and generators, fans and blowers, relays and control panels, business machines timing devices and air handling equipment. ESTCO cylindrical mountings can be loaded in compression, in shear, or in combination compression and shear. Additional standard stud combinations have been added to the line to allow wider applications of these mountings to a customer's design requirements. All engineering data herein apply to mountings with a studded or tapped insert at each end. The maximum unthreaded portion of the stud does not exceed 1/16-inch.

### SELECTION GUIDE

COMPRESSION		MINIMUM LOAD FOR 81% ISOLATION (LBS)									
LOAD RATING	MAXIMUM LOAD (LBS)	FORCING FREQUENCY IN CYCLES PER MINUTE									
		1000	1250	1500	1750	2000	2250	2500	2750	3000	3600
A	4.9					3.9	3.0	2.4	2.0	1.8	1.0
B	6.4					5.3	4.2	3.4	2.9	2.5	1.5
C	10.4					9.8	7.7	6.3	5.2	4.3	2.6
D	13.3					13.1	10.4	8.5	7.0	5.8	4.2

SHEAR		MINIMUM LOAD FOR 81% ISOLATION (LBS)									
LOAD RATING	MAXIMUM LOAD (LBS)	FORCING FREQUENCY IN CYCLES PER MINUTE									
		1000	1250	1500	1750	2000	2250	2500	2750	3000	3600
A	2.7	2.6	1.7	1.2	1.0	.7	.5	*	*	*	*
B	3.6		2.6	1.9	1.4	1.1	.8	.7	.6	*	*
C	5.6		4.7	3.2	2.5	1.9	1.5	1.3	1.1	.9	.7
D	6.4		6.1	4.4	3.4	2.7	2.2	1.8	1.6	1.4	1.0

\* At these forcing frequencies lesser loads will yield 81% isolation.

### DIMENSIONS

LEFT STUD (IN.)		RIGHT STUD (IN.)		SUFFIX
THREAD	LENGTH	THREAD	LENGTH	
8-32	3/8	8-32	3/8	20

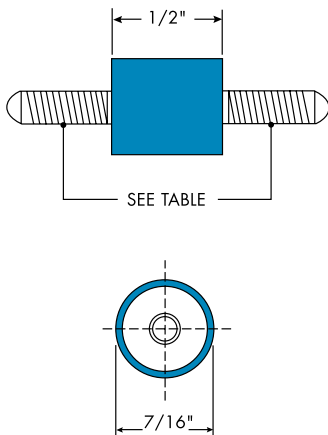

### LOAD DEFLECTION GRAPH

Deflections below the line X---X are considered safe practice for static loads; data above that line are useful for calculating deflections under dynamic loads

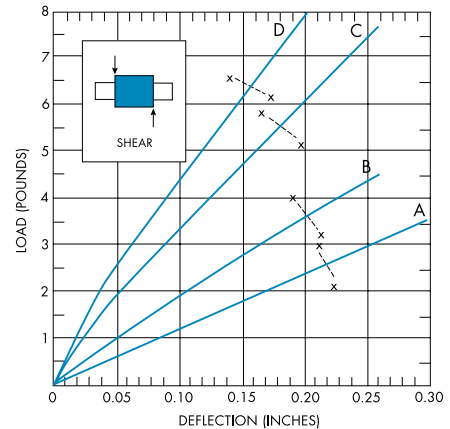
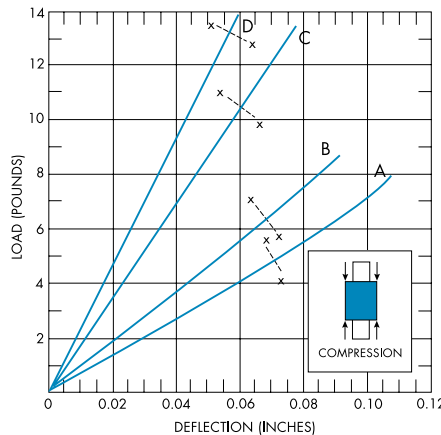

# SERIES 300 CYLINDRICAL MOUNTINGS

Style: **MM304**

For loads to 75 pounds in compression; 42 pounds in shear



## SELECTION GUIDE

COMPRESSION		MINIMUM LOAD FOR 81% ISOLATION (LBS)									
LOAD RATING	MAXIMUM LOAD (LBS)	FORCING FREQUENCY IN CYCLES PER MINUTE									
		850	1100	1250	1500	1750	2000	2250	2500	3000	3600
A	24				29	21	16	12.5	10.5	7.0	5.0
B	32				39.5	28.5	21.5	17.0	14.0	9.5	7.0
C	38					49	37	29.5	24.0	17.0	11.5
D	45					72.5	55	43.5	36	24.5	17.0

SHEAR		MINIMUM LOAD FOR 81% ISOLATION (LBS)									
LOAD RATING	MAXIMUM LOAD (LBS)	FORCING FREQUENCY IN CYCLES PER MINUTE									
		850	1100	1250	1500	1750	2000	2250	2500	3000	3600
A	9	16.0	9.3	7.2	5.0	3.8	2.8	2.3	1.8	1.2	*
B	14		13.0	10.2	7.0	5.3	4.0	3.2	2.6	1.8	*
C	18		24.5	20	14.7	11.2	9.0	7.5	6.2	4.5	3.5
D	21		32	26	19.0	14.8	12.0	10.0	8.3	6.0	5.0

\* At these forcing frequencies lesser loads will yield 81% isolation.

## DIMENSIONS

LEFT STUD (IN.)		RIGHT STUD (IN.)		SUFFIX
THREAD	LENGTH	THREAD	LENGTH	
1/4 - 20	1/4	1/4 - 20	1/4	52
1/4 - 20	1/2	1/4 - 20	*	59
1/4 - 20	1/2	1/4 - 20	13/32	57
1/4 - 20	1/2	1/4 - 20	1/2	• 58
1/4 - 20	1/2	1/4 - 20	5/8	43
1/4 - 20	1/2	1/4 - 20	3/4	45
1/4 - 20	1/2	1/4 - 20	1	55
1/4 - 20	5/8	1/4 - 20	5/8	42

• standard stud \* tapped hole

## LOAD DEFLECTION GRAPH

Deflections below the line X---X are considered safe practice for static loads; data above that line are useful for calculating deflections under dynamic loads

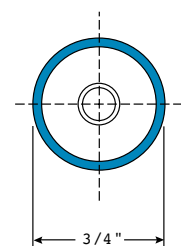
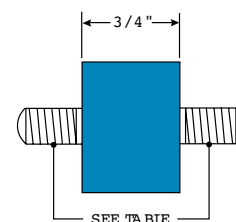
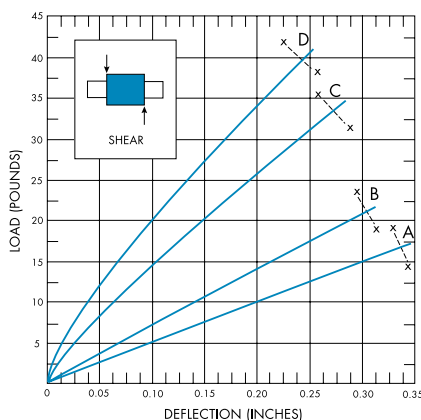
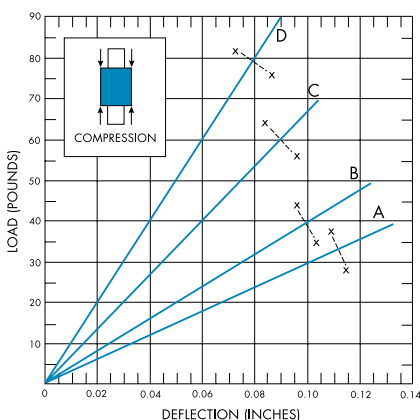

- The small, yet rugged design and the broad range of sizes make ESTCO cylindrical mountings ideal for a wide range of applications. They have been used on electric motors and generators, fans and blowers, relays and control panels, business machines timing devices and air handling equipment. ESTCO cylindrical mountings can be loaded in compression, in shear, or in combination compression and shear. Additional standard stud combinations have been added to the line to allow wider applications of these mountings to a customer's design requirements. All engineering data herein apply to mountings with a studed or tapped insert at each end. The maximum unthreaded portion of the stud does not exceed 1/16-inch.



## SERIES 300 CYLINDRICAL MOUNTINGS

Style: **MM305**

For loads to 75 pounds in compression; 42 pounds in shear

- The small, yet rugged design and the broad range of sizes make ESTCO cylindrical mountings ideal for a wide range of applications. They have been used on electric motors and generators, fans and blowers, relays and control panels, business machines timing devices and air handling equipment. ESTCO cylindrical mountings can be loaded in compression, in shear, or in combination compression and shear. Additional standard stud combinations have been added to the line to allow wider applications of these mountings to a customer's design requirements. All engineering data herein apply to mountings with a studed or tapped insert at each end. The maximum unthreaded portion of the stud does not exceed 1/16-inch.

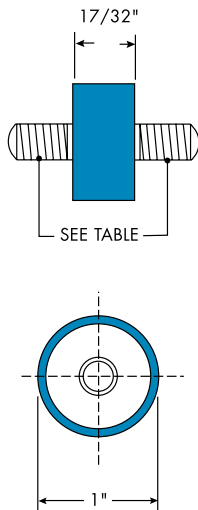

### SELECTION GUIDE

COMPRESSION		MINIMUM LOAD FOR 81% ISOLATION (LBS)									
LOAD RATING	MAXIMUM LOAD (LBS)	FORCING FREQUENCY IN CYCLES PER MINUTE									
		1100	1250	1500	1750	2000	2250	2500	2750	3000	3600
A	40					30.5	24.0	19.5	16.0	13.5	10.0
B	43					38	30	24.8	20.5	17.5	12.5
C	74					74	58.5	47.5	39.5	33	23.5
D	75						67.5	55.5	45.5	38.5	27.5

SHEAR		MINIMUM LOAD FOR 81% ISOLATION (LBS)									
LOAD RATING	MAXIMUM LOAD (LBS)	FORCING FREQUENCY IN CYCLES PER MINUTE									
		1100	1250	1500	1750	2000	2250	2500	2750	3000	3600
A	19	15.7	12.5	8.3	6.3	*	*	*	*	*	*
B	21	19.0	15.5	10.6	8.0	6.3	5.0	*	*	*	*
C	37		31.5	22.5	17.0	14	11.5	9.5	*	*	*
D	42		40	29.2	22.0	18.5	15.8	13	11.0	9.5	*

\* At these forcing frequencies lesser loads will yield 81% isolation.

### DIMENSIONS

LEFT STUD (IN.)		RIGHT STUD (IN.)		
THREAD	LENGTH	THREAD	LENGTH	SUFFIX
10-24	3/8	10-24	3/8	32
10-24	3/8	10-24	1/2	33
10-24	1/2	10-24	1/2	34
1/4 - 20	1/2	1/4 - 20	1/2	• 58
1/4 - 20	1/2	1/4 - 20	5/8	43
1/4 - 20	1/2	1/4 - 20	3/4	45
1/4 - 20	3/4	1/4 - 20	3/4	46

• standard stud

### LOAD DEFLECTION GRAPH

Deflections below the line X---X are considered safe practice for static loads; data above that line are useful for calculating deflections under dynamic loads

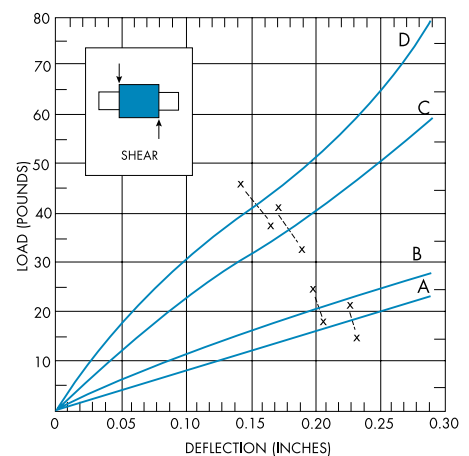
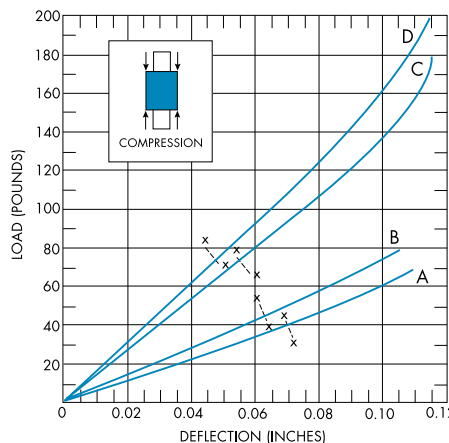



# SERIES 300 CYLINDRICAL MOUNTINGS

Style: **MM307**

For loads to 28.5 pounds in compression; 11.9 pounds in shear



## SELECTION GUIDE

COMPRESSION		MINIMUM LOAD FOR 81% ISOLATION (LBS)						
LOAD RATING	MAXIMUM LOAD (LBS)	FORCING FREQUENCY IN CYCLES PER MINUTE						
		1500	1750	2000	2250	2500	3000	3600
A	22.0				21.5	16.5	10.5	6.5
B	28.5					25.5	17.0	12.0

SHEAR		MINIMUM LOAD FOR 81% ISOLATION (LBS)						
LOAD RATING	MAXIMUM LOAD (LBS)	FORCING FREQUENCY IN CYCLES PER MINUTE						
		1500	1750	2000	2250	2500	3000	3600
A	8.4	6.2	4.7	3.7	3.0	2.4	*	*
B	11.9	9.9	7.3	5.6	4.4	3.6	2.5	*

\* At these forcing frequencies lesser loads will yield 81% isolation.

## DIMENSIONS

LEFT STUD (IN.)		RIGHT STUD (IN.)		SUFFIX
THREAD	LENGTH	THREAD	LENGTH	
1/4-20	.410	1/4 - 20	.410	60

## LOAD DEFLECTION GRAPH

Deflections below the line X---X are considered safe practice for static loads; data above that line are useful for calculating deflections under dynamic loads

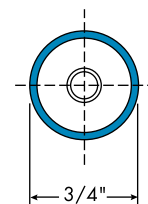
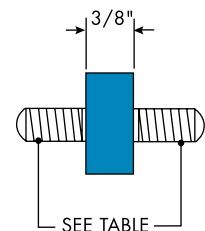
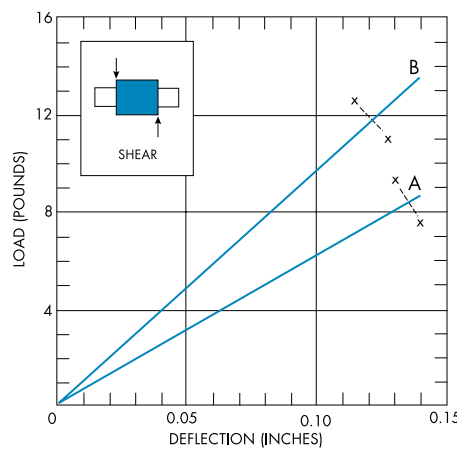
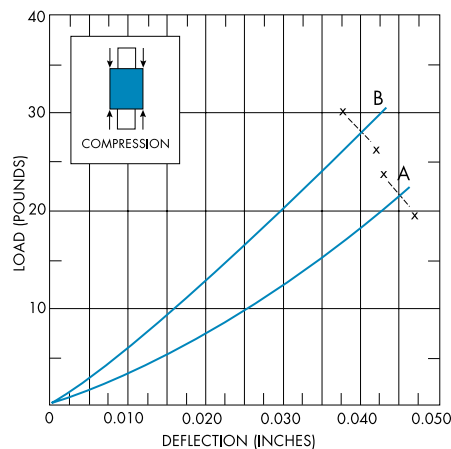

- The small, yet rugged design and the broad range of sizes make ESTCO cylindrical mountings ideal for a wide range of applications. They have been used on electric motors and generators, fans and blowers, relays and control panels, business machines timing devices and air handling equipment. ESTCO cylindrical mountings can be loaded in compression, in shear, or in combination compression and shear. Additional standard stud combinations have been added to the line to allow wider applications of these mountings to a customer's design requirements. All engineering data herein apply to mountings with a studded or tapped insert at each end. The maximum unthreaded portion of the stud does not exceed 1/16-inch.





## SERIES 300 CYLINDRICAL MOUNTINGS

Style: **MM308**

*For loads to 210 pounds in compression; not recommended for static loads in shear*

- The small, yet rugged design and the broad range of sizes make ESTCO cylindrical mountings ideal for a wide range of applications. They have been used on electric motors and generators, fans and blowers, relays and control panels, business machines timing devices and air handling equipment. ESTCO cylindrical mountings can be loaded in compression, in shear, or in combination compression and shear. Additional standard stud combinations have been added to the line to allow wider applications of these mountings to a customer's design requirements. All engineering data herein apply to mountings with a studded or tapped insert at each end. The maximum unthreaded portion of the stud does not exceed 1/16-inch.

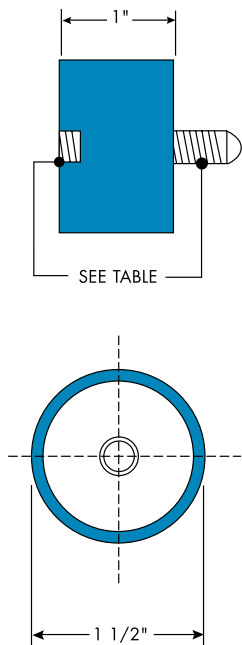

### SELECTION GUIDE

COMPRESSION		MINIMUM LOAD FOR 81% ISOLATION (LBS)						
LOAD RATING	MAXIMUM LOAD (LBS)	FORCING FREQUENCY IN CYCLES PER MINUTE						
		1150	1250	1500	1750	2000	2750	3500
A	95	95	80	55	40	30	15	
B	135		125	85	60	45	22	
C	185			140	100	75	40	25
D	210			185	135	105	55	35

### DIMENSIONS

LEFT STUD (IN.)		RIGHT STUD (IN.)		SUFFIX
THREAD	LENGTH	THREAD	LENGTH	
5/16 - 18	9/16	5/16 - 18	*	• 87
5/16 - 18	7/8	5/16 - 18	*	85

\* tapped hole • standard stud

### LOAD DEFLECTION GRAPH

Deflections below the line X---X are considered safe practice for static loads; data above that line are useful for calculating deflections under dynamic loads

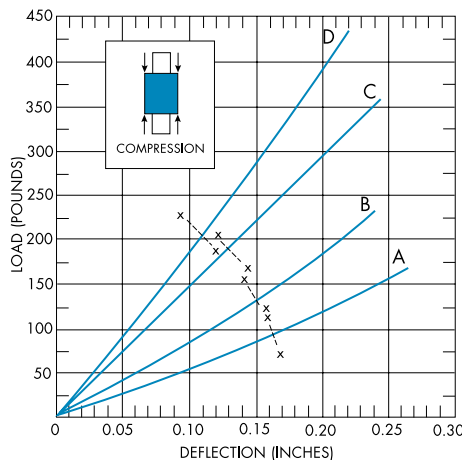

### GENERAL INFORMATION

#### Compression:

When specified as a direction for loading a rubber pad - A deformation caused by squeezing the layers of the object in a direction perpendicular to the layers.

#### Shear:

When specified as a direction for loading a rubber pad - A deformation caused by sliding layers of an object past each-other in a direction parallel to the layers.



ISO 9001 Certified  
CERTIFICATE # 08-511

# SERIES 300 CYLINDRICAL MOUNTINGS

Style: **MM310**

For loads to 120 pounds in compression; 63 pounds in shear



## SELECTION GUIDE

COMPRESSION		MINIMUM LOAD FOR 81% ISOLATION (LBS)									
LOAD RATING	MAXIMUM LOAD (LBS)	FORCING FREQUENCY IN CYCLES PER MINUTE									
		700	850	950	1100	1250	1500	1750	2000	2500	3000
A	41				34.5	27.5	19	14	10	7	
B	64					48	32	24	17.5	12	8.5
C	90					80	55	41.5	30	20	14
D	120						89	70.5	53	38.5	26.5

SHEAR		MINIMUM LOAD FOR 81% ISOLATION (LBS)									
LOAD RATING	MAXIMUM LOAD (LBS)	FORCING FREQUENCY IN CYCLES PER MINUTE									
		700	850	950	1100	1250	1500	1750	2000	2500	3000
A	21	20	11.0	8.5	6.7	5.5	*	*	*	*	*
B	31		18	14	10.5	8	5.5	*	*	*	*
C	48		31.5	25	19.5	15.5	11	8.5	*	*	*
D	63		50	41	32.6	27.5	20.5	16	14	8	*

\* At these forcing frequencies lesser loads will yield 81% isolation.

## DIMENSIONS

LEFT STUD (IN.)		RIGHT STUD (IN.)		SUFFIX
THREAD	LENGTH	THREAD	LENGTH	
5/16 - 18	1/2	5/16 - 18	1/2	68
5/16 - 18	9/16	5/16 - 18	9/16	• 76
5/16 -	9/16	5/16 - 18	3/4	75
185/16 - 18	3/4	5/16 - 18	3/4	70
5/16 - 18	7/8	5/16 - 18	7/8	80

• standard stud

## LOAD DEFLECTION GRAPH

Deflections below the line X---X are considered safe practice for static loads; data above that line are useful for calculating deflections under dynamic loads

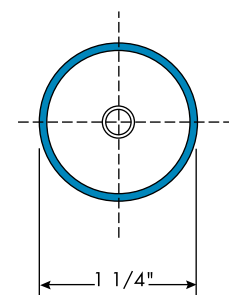
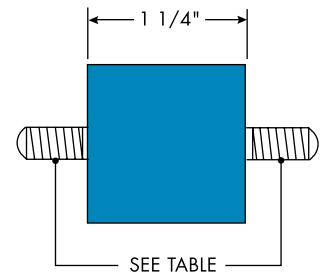
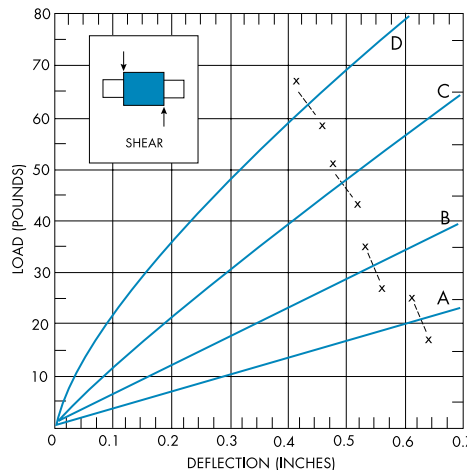
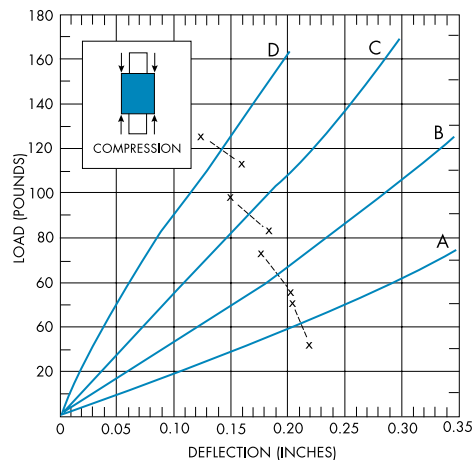

- The small, yet rugged design and the broad range of sizes make ESTCO cylindrical mountings ideal for a wide range of applications. They have been used on electric motors and generators, fans and blowers, relays and control panels, business machines timing devices and air handling equipment. ESTCO cylindrical mountings can be loaded in compression, in shear, or in combination compression and shear. Additional standard stud combinations have been added to the line to allow wider applications of these mountings to a customer's design requirements. All engineering data herein apply to mountings with a studded or tapped insert at each end. The maximum unthreaded portion of the stud does not exceed 1/16-inch.



### SERIES 300 CYLINDRICAL MOUNTINGS

Style: **MM311**

For loads to 105 pounds in compression; 66 pounds in shear

- The small, yet rugged design and the broad range of sizes make ESTCO cylindrical mountings ideal for a wide range of applications. They have been used on electric motors and generators, fans and blowers, relays and control panels, business machines timing devices and air handling equipment. ESTCO cylindrical mountings can be loaded in compression, in shear, or in combination compression and shear. Additional standard stud combinations have been added to the line to allow wider applications of these mountings to a customer's design requirements. All engineering data herein apply to mountings with a studded or tapped insert at each end. The maximum unthreaded portion of the stud does not exceed 1/16-inch.

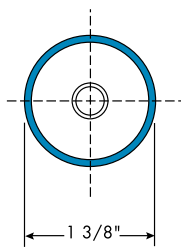
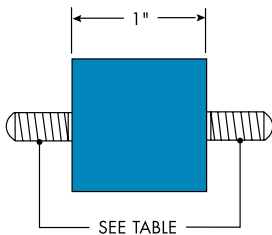

#### SELECTION GUIDE

COMPRESSION		MINIMUM LOAD FOR 81% ISOLATION (LBS)									
LOAD RATING	MAXIMUM LOAD (LBS)	FORCING FREQUENCY IN CYCLES PER MINUTE									
		700	850	1100	1250	1500	1750	2000	2250	2500	3000
A	47				44.5	30	22	18	13.5	11	
B	74				72.5	48.5	35.5	27	21	17.5	12.5
C	96					75.7	55.5	43	34	28	19.5
D	105					100	73	56.5	45	38	25.5

SHEAR		MINIMUM LOAD FOR 81% ISOLATION (LBS)									
LOAD RATING	MAXIMUM LOAD (LBS)	FORCING FREQUENCY IN CYCLES PER MINUTE									
		700	850	1100	1250	1500	1750	2000	2250	2500	3000
A	27	27	19.5	11.5	9	6	*	*	*	*	*
B	41		31	19	14.5	10.5	8	*	*	*	*
C	66		53.5	33	26.5	19	14	11.5	9	*	*
D	66		61	38	30.5	22	19.5	13	10.5	8.5	*

\* At these forcing frequencies lesser loads will yield 81% isolation.

#### DIMENSIONS

LEFT STUD (IN.)		RIGHT STUD (IN.)		SUFFIX
THREAD	LENGTH	THREAD	LENGTH	
5/16 - 18	1/2	5/16 - 18	7/8	71
5/16 - 18	9/16	5/16 - 18	9/16	• 76
5/16 -	9/16	5/16 - 18	3/4	75
185/16 - 18	3/4	5/16 - 18	3/4	70
5/16 - 18	7/8	5/16 - 18	7/8	80

• standard stud

#### LOAD DEFLECTION GRAPH

Deflections below the line X---X are considered safe practice for static loads; data above that line are useful for calculating deflections under dynamic loads

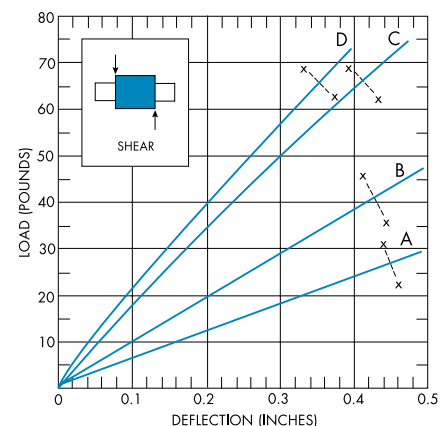
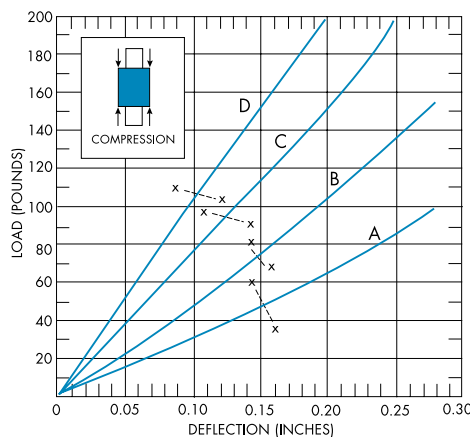

# SERIES 300 CYLINDRICAL MOUNTINGS

Style: **MM312**

For loads to 185 pounds in compression; 67 pounds in shear



## SELECTION GUIDE

COMPRESSION		MINIMUM LOAD FOR 81% ISOLATION (LBS)									
LOAD RATING	MAXIMUM LOAD (LBS)	FORCING FREQUENCY IN CYCLES PER MINUTE									
		950	1100	1250	1500	1750	2000	2250	2500	3000	3600
A	93					71	51	39	31	25	
B	118					106	81	64	52	43	35
C	158						121	96	79	65	54
D	185						164	131	109	90	74

SHEAR		MINIMUM LOAD FOR 81% ISOLATION (LBS)									
LOAD RATING	MAXIMUM LOAD (LBS)	FORCING FREQUENCY IN CYCLES PER MINUTE									
		950	1100	1250	1500	1750	2000	2250	2500	3000	3600
A	36	34	25	19	13.5	10	*	*	*	*	*
B	46		38	30	21	16	12	9.5	*	*	*
C	57			50	35	26	20	16	13	*	*
D	67			66	46	34	26	21	18	14	*

\* At these forcing frequencies lesser loads will yield 81% isolation

## DIMENSIONS

LEFT STUD (IN.)		RIGHT STUD (IN.)		SUFFIX
THREAD	LENGTH	THREAD	LENGTH	
5/16 - 18	1/2	5/16 - 18	1/2	68
5/16 - 18	1/2	5/16 - 18	3/4	69
5/16 -	9/16	5/16 - 18	9/16	• 76
185/16 - 18	5/8	5/16 - 18	5/8	72

• standard stud

## LOAD DEFLECTION GRAPH

Deflections below the line X---X are considered safe practice for static loads; data above that line are useful for calculating deflections under dynamic loads

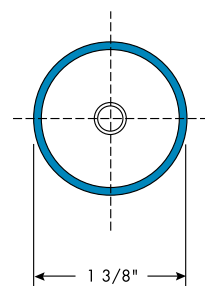
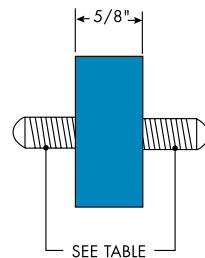
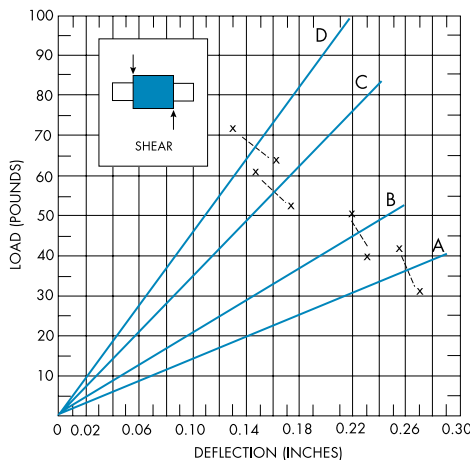
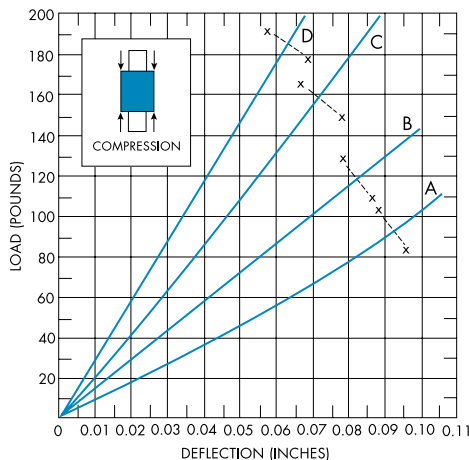

- The small, yet rugged design and the broad range of sizes make ESTCO cylindrical mountings ideal for a wide range of applications. They have been used on electric motors and generators, fans and blowers, relays and control panels, business machines timing devices and air handling equipment. ESTCO cylindrical mountings can be loaded in compression, in shear, or in combination compression and shear. Additional standard stud combinations have been added to the line to allow wider applications of these mountings to a customer's design requirements. All engineering data herein apply to mountings with a studded or tapped insert at each end. The maximum unthreaded portion of the stud does not exceed 1/16-inch.



## SERIES 300 CYLINDRICAL MOUNTINGS

Style: **MM314**

For loads to 142 pounds in compression; 64 pounds in shear

- The small, yet rugged design and the broad range of sizes make ESTCO cylindrical mountings ideal for a wide range of applications. They have been used on electric motors and generators, fans and blowers, relays and control panels, business machines timing devices and air handling equipment. ESTCO cylindrical mountings can be loaded in compression, in shear, or in combination compression and shear. Additional standard stud combinations have been added to the line to allow wider applications of these mountings to a customer's design requirements. All engineering data herein apply to mountings with a studded or tapped insert at each end. The maximum unthreaded portion of the stud does not exceed 1/16-inch.

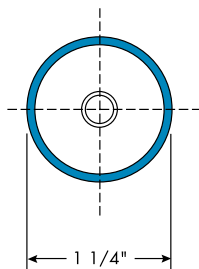
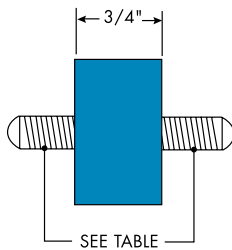

### SELECTION GUIDE

COMPRESSION		MINIMUM LOAD FOR 81% ISOLATION (LBS)									
LOAD RATING	MAXIMUM LOAD (LBS)	FORCING FREQUENCY IN CYCLES PER MINUTE									
		950	1100	1250	1500	1750	2000	2250	2500	3000	3600
A	56				50	38	28.5	22.5	18	12.5	
B	73				73	51	39	30.5	24.5	16.5	12
C	109					85	63.5	50	41	28	20
D	142					129	99	78	64	44	30

SHEAR		MINIMUM LOAD FOR 81% ISOLATION (LBS)									
LOAD RATING	MAXIMUM LOAD (LBS)	FORCING FREQUENCY IN CYCLES PER MINUTE									
		950	1100	1250	1500	1750	2000	2250	2500	3000	3600
A	32	23	18	14.5	10	7.5	*	*	*	*	*
B	38	32	24.5	19	13	9.5	7	*	*	*	*
C	51		44.5	36	26	19.5	14	12	10	*	*
D	64		58	46.5	34	27	20.5	17	14	9.5	*

\* At these forcing frequencies lesser loads will yield 81% isolation.

### DIMENSIONS

LEFT STUD (IN.)		RIGHT STUD (IN.)		SUFFIX
THREAD	LENGTH	THREAD	LENGTH	
5/16 - 18	1/2	5/16 - 18	1/2	68
5/16 - 18	1/2	5/16 - 18	3/4	69
5/16 -	9/16	5/16 - 18	9/16	• 76
185/16 - 18	9/16	5/16 - 18	3/4	75
5/16 - 18	3/4	5/16 - 18	3/4	70

• standard stud

### LOAD DEFLECTION GRAPH

Deflections below the line X---X are considered safe practice for static loads; data above that line are useful for calculating deflections under dynamic loads

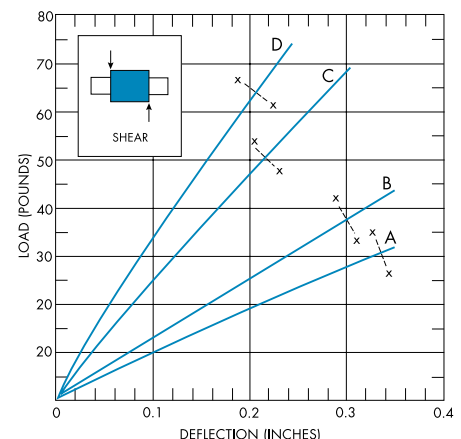
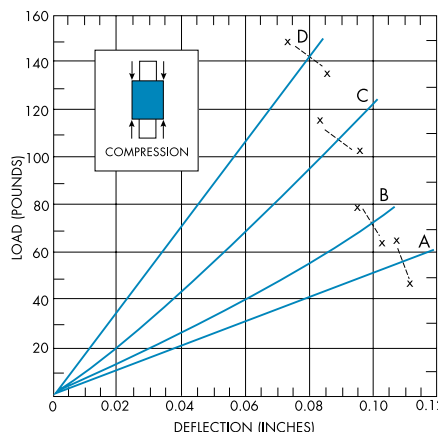

# SERIES 300 CYLINDRICAL MOUNTINGS

Style: **MM315**

For loads to 123 pounds in compression; 63 pounds in shear



## SELECTION GUIDE

COMPRESSION		MINIMUM LOAD FOR 81% ISOLATION (LBS)									
LOAD RATING	MAXIMUM LOAD (LBS)	FORCING FREQUENCY IN CYCLES PER MINUTE									
		750	850	950	1100	1250	1500	1750	2000	2500	3000
A	56						40	28	21	13	
B	82						68.5	50	35	23	17
C	115						107	77.5	57	27.5	22
D	123							92	67.5	43	32

SHEAR		MINIMUM LOAD FOR 81% ISOLATION (LBS)									
LOAD RATING	MAXIMUM LOAD (LBS)	FORCING FREQUENCY IN CYCLES PER MINUTE									
		750	850	950	1100	1250	1500	1750	2000	2500	3000
A	32	31	24	19	14	11	8	5.6	*	*	*
B	37		32	26	19	15	10	7.6	5.7	*	*
C	48		45	38	29	24	17	13	10	6.5	*
D	63			56	45	38	27	21	17	11	8

\* At these forcing frequencies lesser loads will yield 81% isolation

## DIMENSIONS

LEFT STUD (IN.)		RIGHT STUD (IN.)		SUFFIX
THREAD	LENGTH	THREAD	LENGTH	
5/16 - 18	1/2	5/16 - 18	3/4	69
5/16 - 18	1/2	5/16 - 18	7/8	71
5/16 -	9/16	5/16 - 18	9/16	• 76
185/16 - 18	5/8	5/16 - 18	5/8	72
5/16 - 18	3/4	5/16 - 18	3/4	70

• standard stud

## LOAD DEFLECTION GRAPH

Deflections below the line X---X are considered safe practice for static loads; data above that line are useful for calculating deflections under dynamic loads

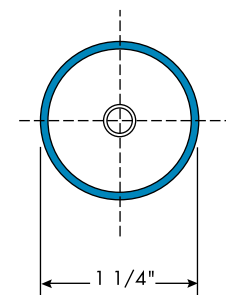
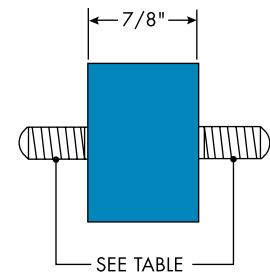
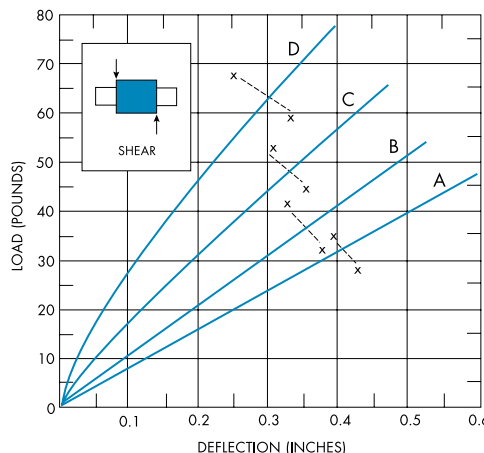
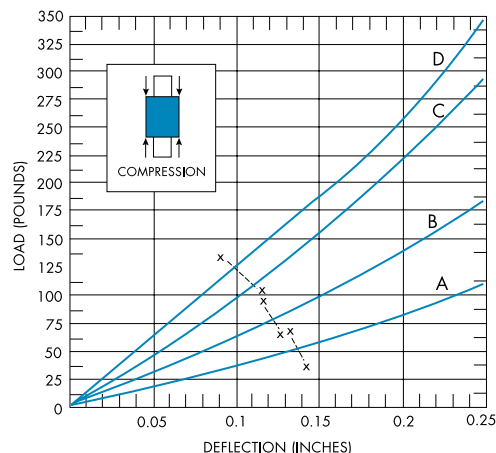

- The small, yet rugged design and the broad range of sizes make ESTCO cylindrical mountings ideal for a wide range of applications. They have been used on electric motors and generators, fans and blowers, relays and control panels, business machines timing devices and air handling equipment. ESTCO cylindrical mountings can be loaded in compression, in shear, or in combination compression and shear. Additional standard stud combinations have been added to the line to allow wider applications of these mountings to a customer's design requirements. All engineering data herein apply to mountings with a studded or tapped insert at each end. The maximum unthreaded portion of the stud does not exceed 1/16-inch.



## SERIES 300 CYLINDRICAL MOUNTINGS

Styles: **MM316/319**

For loads to 86 pounds in compression; 43 pounds in shear

- The small, yet rugged design and the broad range of sizes make ESTCO cylindrical mountings ideal for a wide range of applications. They have been used on electric motors and generators, fans and blowers, relays and control panels, business machines timing devices and air handling equipment. ESTCO cylindrical mountings can be loaded in compression, in shear, or in combination compression and shear. Additional standard stud combinations have been added to the line to allow wider applications of these mountings to a customer's design requirements. All engineering data herein apply to mountings with a studed or tapped insert at each end. The maximum unthreaded portion of the stud does not exceed 1/16-inch.

### SELECTION GUIDE

COMPRESSION		MINIMUM LOAD FOR 81% ISOLATION (LBS)									
LOAD RATING	MAXIMUM LOAD (LBS)	FORCING FREQUENCY IN CYCLES PER MINUTE									
		700	950	1100	1250	1500	1750	2000	2250	2500	3000
A	37				35	24	18	13.5	11		
B	48					34	26	20.5	16	13	
C	57					46	32.5	26.5	20	16	
D	86					80	59	48	36	30	21

SHEAR		MINIMUM LOAD FOR 81% ISOLATION (LBS)									
LOAD RATING	MAXIMUM LOAD (LBS)	FORCING FREQUENCY IN CYCLES PER MINUTE									
		700	950	1100	1250	1500	1750	2000	2250	2500	3000
A	16	16	8	6.5	5.0	3.5	*	*	*	*	*
B	21		12.5	9.5	7.5	5.5	4	*	*	*	*
C	35		23.5	18	14	10	7.5	6	*	*	*
D	43		32	24.5	19	13	9.5	7.5	*	*	*

\* At these forcing frequencies lesser loads will yield 81% isolation.

### DIMENSIONS

LEFT STUD (IN.)		RIGHT STUD (IN.)		SUFFIX
THREAD	LENGTH	THREAD	LENGTH	
5/16 - 18	*	5/16 - 18	*	≈ 66
5/16 - 18	1/2	5/16 - 18	3/4	69
5/16 -	9/16	5/16 - 18	9/16	• 76
185/16 - 18	5/8	5/16 - 18	5/8	72
5/16 - 18	3/4	5/16 - 18	3/4	70

(style 319)

\* tapped hole • standard stud ≈ style 319

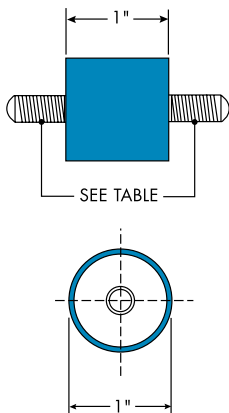

### LOAD DEFLECTION GRAPH

Deflections below the line X---X are considered safe practice for static loads; data above that line are useful for calculating deflections under dynamic loads

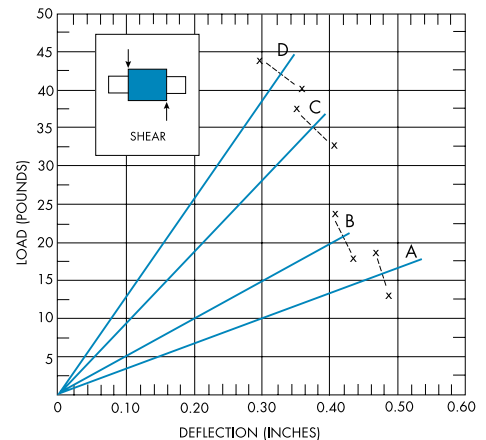
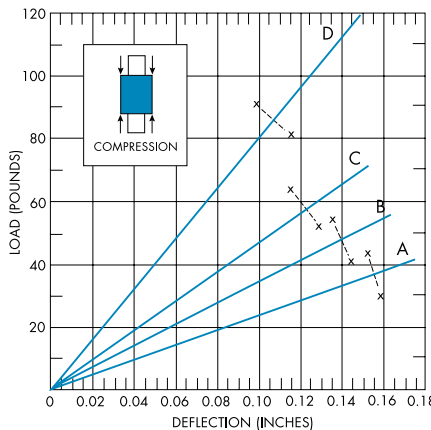



# SERIES 300 CYLINDRICAL MOUNTINGS

Style: **MM321**

For loads to 13.8 pounds in compression; 7.1 pounds in shear

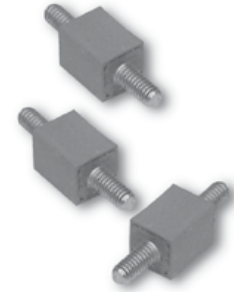

## SELECTION GUIDE

COMPRESSION		MINIMUM LOAD FOR 81% ISOLATION (LBS)									
LOAD RATING	MAXIMUM LOAD (LBS)	FORCING FREQUENCY IN CYCLES PER MINUTE									
		1100	1250	1500	1750	2000	2250	2500	2750	3000	3600
A	5.1				5.1	3.9	3.1	2.6	2.1	1.8	
B	6.4					5.5	4.3	3.4	2.8	2.4	1.8
C	11.1					11.0	8.7	7.1	6.0	5.1	3.8
D	13.8						12.3	10.3	8.9	7.7	5.9

SHEAR		MINIMUM LOAD FOR 81% ISOLATION (LBS)									
LOAD RATING	MAXIMUM LOAD (LBS)	FORCING FREQUENCY IN CYCLES PER MINUTE									
		1100	1250	1500	1750	2000	2250	2500	2750	3000	3600
A	2.6	2.4	1.8	1.3	.9	.7	.6	*	*	*	*
B	3.6	3.4	2.8	1.9	1.4	1.0	.8	.7	.6	*	*
C	5.7		4.9	3.6	2.9	2.2	1.8	1.5	1.3	1.1	.9
D	7.1		7.0	5.1	3.9	3.1	2.6	2.1	1.8	1.6	1.2

\* At these forcing frequencies lesser loads will yield 81% isolation

## DIMENSIONS

LEFT STUD (IN.)		RIGHT STUD (IN.)		SUFFIX
THREAD	LENGTH	THREAD	LENGTH	
8-32	7/32	8-32	7/32	22
8-32	7/32	8-32	9/16	23
8-32	3/8	8-32	3/8	• 14
8-32	3/8	8-32	9/16	21
8-32	9/16	8-32	9/16	26

• standard stud

## LOAD DEFLECTION GRAPH

Deflections below the line X---X are considered safe practice for static loads; data above that line are useful for calculating deflections under dynamic loads

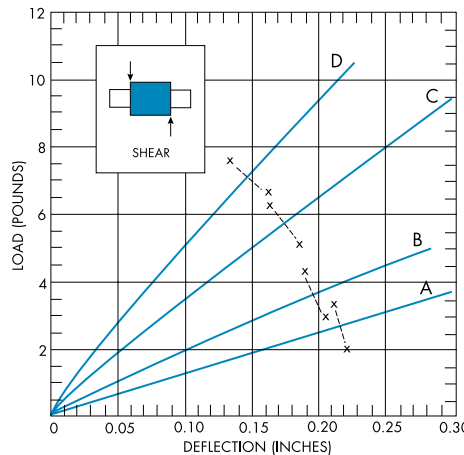
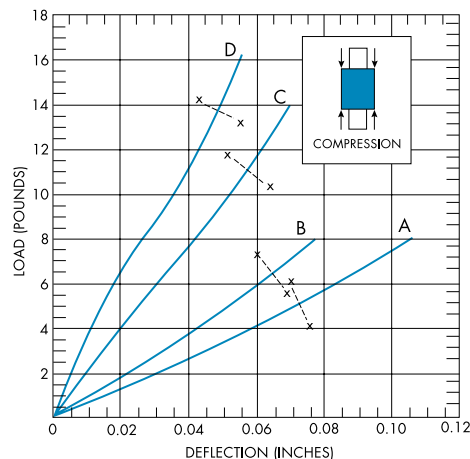

- The small, yet rugged design and the broad range of sizes make ESTCO cylindrical mountings ideal for a wide range of applications. They have been used on electric motors and generators, fans and blowers, relays and control panels, business machines timing devices and air handling equipment. ESTCO cylindrical mountings can be loaded in compression, in shear, or in combination compression and shear. Additional standard stud combinations have been added to the line to allow wider applications of these mountings to a customer's design requirements. All engineering data herein apply to mountings with a studded or tapped insert at each end. The maximum unthreaded portion of the stud does not exceed 1/16-inch.

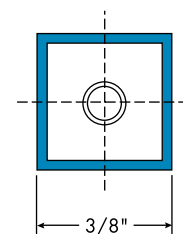
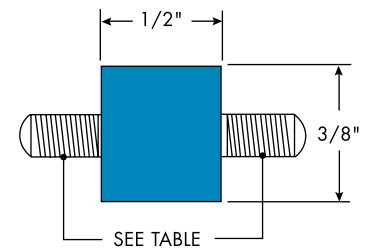

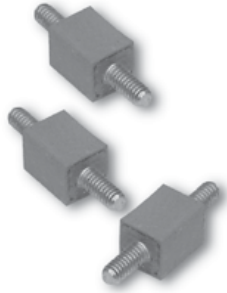

### SERIES 300 CYLINDRICAL MOUNTINGS

Style: **MM322**

For loads to 15.4 pounds in compression; 9.9 pounds in shear

- The small, yet rugged design and the broad range of sizes make ESTCO cylindrical mountings ideal for a wide range of applications. They have been used on electric motors and generators, fans and blowers, relays and control panels, business machines timing devices and air handling equipment. ESTCO cylindrical mountings can be loaded in compression, in shear, or in combination compression and shear. Additional standard stud combinations have been added to the line to allow wider applications of these mountings to a customer's design requirements. All engineering data herein apply to mountings with a studded or tapped insert at each end. The maximum unthreaded portion of the stud does not exceed 1/16-inch.

#### SELECTION GUIDE

COMPRESSION		MINIMUM LOAD FOR 81% ISOLATION (LBS)							
LOAD RATING	MAXIMUM LOAD (LBS)	FORCING FREQUENCY IN CYCLES PER MINUTE							
		1500	1750	2000	2250	2500	2750	3000	3600
A	6.6						5.4	4.5	3.2
B	8.7						8.5	6.9	4.8
C	12.0							11.5	8.0
D	15.4								11.8

SHEAR		MINIMUM LOAD FOR 81% ISOLATION (LBS)							
LOAD RATING	MAXIMUM LOAD (LBS)	FORCING FREQUENCY IN CYCLES PER MINUTE							
		1500	1750	2000	2250	2500	2750	3000	3600
A	4.4	3.3	2.4	1.9	1.5	1.3	1.1	*	*
B	5.6	4.8	3.6	2.8	2.2	1.9	1.6	*	*
C	7.8	7.7	6.0	4.9	4.0	3.5	3.1	*	*
D	9.9		8.2	6.7	5.6	4.7	4.1	*	*

\* At these forcing frequencies lesser loads will yield 81% isolation.

#### DIMENSIONS

LEFT STUD (IN.)		RIGHT STUD (IN.)		SUFFIX
THREAD	LENGTH	THREAD	LENGTH	
8-32	7/32	8-32	7/32	• 22
8-32	7/32	8-32	9/16	23
8-32	3/8	8-32	3/8	14
8-32	3/8	8-32	9/16	21
8-32	9/16	8-32	9/16	26

• standard stud

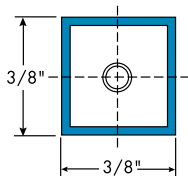
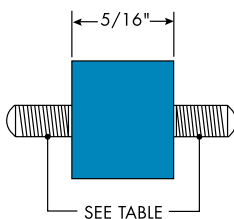

#### LOAD DEFLECTION GRAPH

Deflections below the line X---X are considered safe practice for static loads; data above that line are useful for calculating deflections under dynamic loads

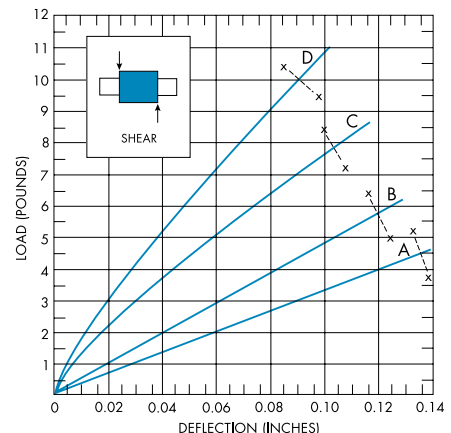
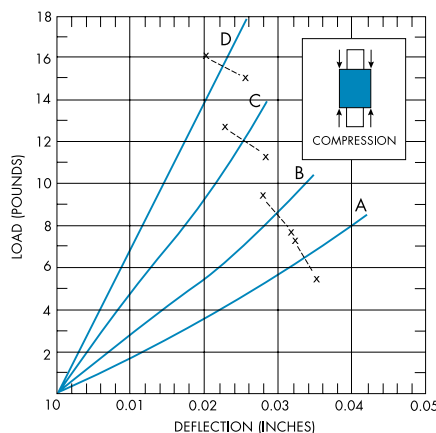

# SERIES 300 CYLINDRICAL MOUNTINGS

Style: **MM323**

For loads to 14.5 pounds in compression; 7.3 pounds in shear



## SELECTION GUIDE

COMPRESSION		MINIMUM LOAD FOR 81% ISOLATION (LBS)							
LOAD RATING	MAXIMUM LOAD (LBS)	FORCING FREQUENCY IN CYCLES PER MINUTE							
		950	1100	250	1500	1750	2000	2250	2500
A	6.8					5.5	3.8	3.0	2.5
B	8.5					8.0	6.0	4.5	3.5
C	12.0						10.1	8.5	6.5
D	14.5						14.5	11.5	9.0

SHEAR		MINIMUM LOAD FOR 81% ISOLATION (LBS)							
LOAD RATING	MAXIMUM LOAD (LBS)	FORCING FREQUENCY IN CYCLES PER MINUTE							
		950	1100	250	1500	1750	2000	2250	2500
A	2.8	2.8	2.2	1.6	1.1	.9	.7	*	*
B	3.3		2.8	2.1	1.6	1.2	.9	*	*
C	5.3		5.0	4.0	2.9	2.3	1.9	1.6	*
D	7.3			6.2	4.6	3.6	2.9	2.5	2.2

\* At these forcing frequencies lesser loads will yield 81% isolation

## DIMENSIONS

LEFT STUD (IN.)		RIGHT STUD (IN.)		SUFFIX
THREAD	LENGTH	THREAD	LENGTH	
8-32	3/8	8-32	3/8	14
8-32	3/8	8-32	3/8	17
8-32	9/16	8-32	9/16	• 28

• standard stud

## LOAD DEFLECTION GRAPH

Deflections below the line X---X are considered safe practice for static loads; data above that line are useful for calculating deflections under dynamic loads

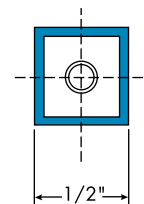
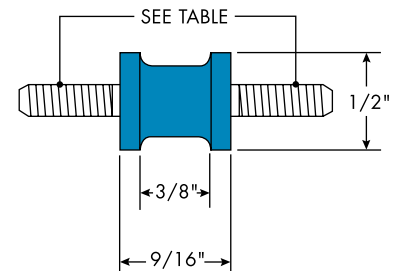
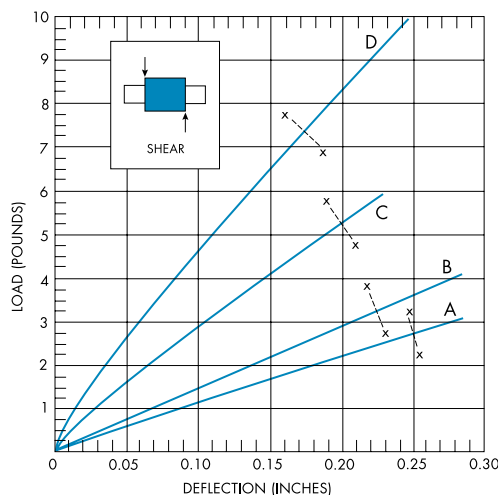
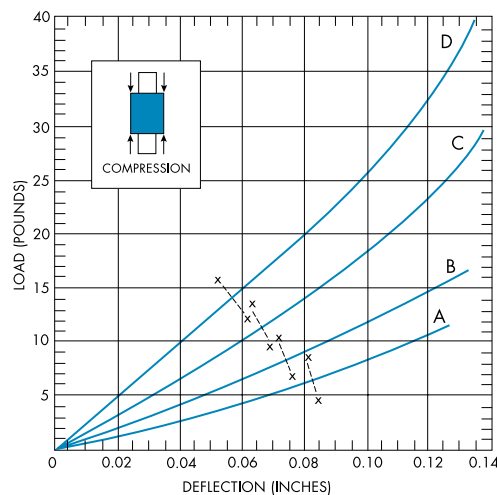

- The small, yet rugged design and the broad range of sizes make ESTCO cylindrical mountings ideal for a wide range of applications. They have been used on electric motors and generators, fans and blowers, relays and control panels, business machines timing devices and air handling equipment. ESTCO cylindrical mountings can be loaded in compression, in shear, or in combination compression and shear. Additional standard stud combinations have been added to the line to allow wider applications of these mountings to a customer's design requirements. All engineering data herein apply to mountings with a studded or tapped insert at each end. The maximum unthreaded portion of the stud does not exceed 1/16-inch.



## SERIES 300 CYLINDRICAL MOUNTINGS

Style: **MM330**

For loads to 330 pounds in compression; 140 pounds in shear

- The small, yet rugged design and the broad range of sizes make ESTCO cylindrical mountings ideal for a wide range of applications. They have been used on electric motors and generators, fans and blowers, relays and control panels, business machines timing devices and air handling equipment. ESTCO cylindrical mountings can be loaded in compression, in shear, or in combination compression and shear. Additional standard stud combinations have been added to the line to allow wider applications of these mountings to a customer's design requirements. All engineering data herein apply to mountings with a studded or tapped insert at each end. The maximum unthreaded portion of the stud does not exceed 1/16-inch.

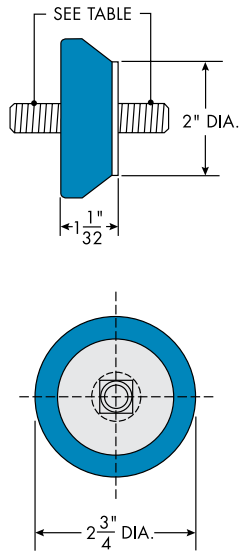

### SELECTION GUIDE

COMPRESSION		MINIMUM LOAD FOR 81% ISOLATION (LBS)								
LOAD RATING	MAXIMUM LOAD (LBS)	FORCING FREQUENCY IN CYCLES PER MINUTE								
		700	850	1100	1250	1500	1750	2000	2250	2500
B	330					255	190	150	120	90

SHEAR		MINIMUM LOAD FOR 81% ISOLATION (LBS)								
LOAD RATING	MAXIMUM LOAD (LBS)	FORCING FREQUENCY IN CYCLES PER MINUTE								
		700	850	1100	1250	1500	1750	2000	2250	2500
B	140	140	105	65	52	38	32	*	*	*

\* At these forcing frequencies lesser loads will yield 81% isolation.

### DIMENSIONS

LEFT STUD (IN.)		RIGHT STUD (IN.)		SUFFIX
THREAD	LENGTH	THREAD	LENGTH	
1/2 - 13	1 1/4	1/2 - 13	1 1/4	38
1/2 - 20	11/16	1/2 - 20	11/16	44
1/2 - 20	29/32	1/2 - 20	29/32	• 40

• standard stud

### LOAD DEFLECTION GRAPH

Deflections below the line X---X are considered safe practice for static loads; data above that line are useful for calculating deflections under dynamic loads

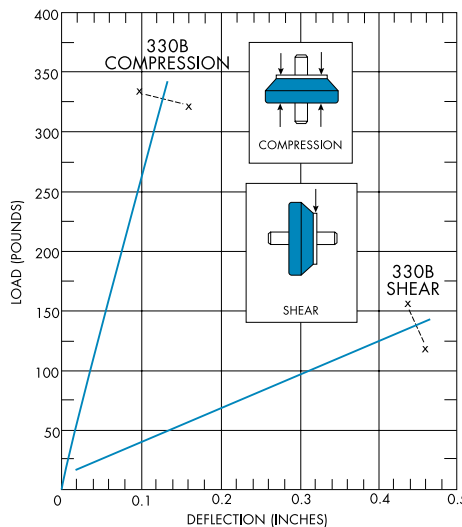

Load ratings in the SELECTION GUIDE charts correspond to various durometers (or hardness) of the rubber formula used...

"A" corresponds to a 30 durometer;  
"B" corresponds to a 40 durometer;  
"C" corresponds to a 50 durometer;  
"D" corresponds to a 60 durometer



ISO 9001 Certified  
CERTIFICATE # 08-511

# SERIES 540 RECTANGULAR MOUNTINGS

Style: **MM540**

For loads to 320 pounds in compression; Not recommended for shear load applications



## SELECTION GUIDE

COMPRESSION		MINIMUM LOAD FOR 81% ISOLATION (LBS)				
LOAD RATING	MAXIMUM LOAD (LBS)	FORCING FREQUENCY IN CYCLES PER MINUTE				
		2000	2250	2500	2750	3000
B	320	320	280	230	185	160

## DIMENSIONS

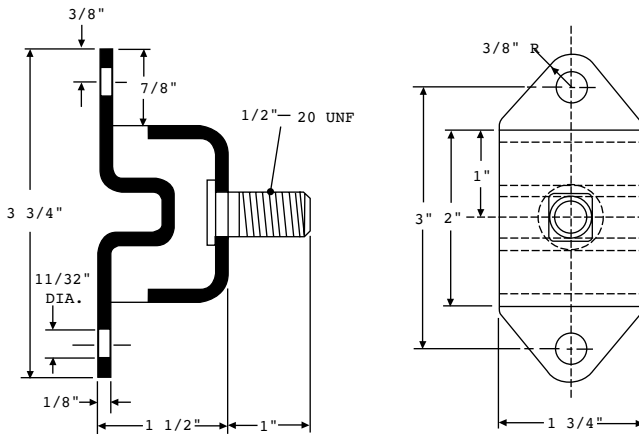

- These compact and rugged ESTCO rectangular mountings are built to support heavy machinery such as large blowers and compressors, engines, motors, presses and rock crushers. In addition to supporting loads in compression, they can isolate vibration occurring in a horizontal direction. Steel plates are chemically bonded to the top and bottom surfaces of the rubber to assure long operating life.

## LOAD DEFLECTION GRAPH

Deflections below the line X---X are considered safe practice for static loads; data above that line are useful for calculating deflections under dynamic loads

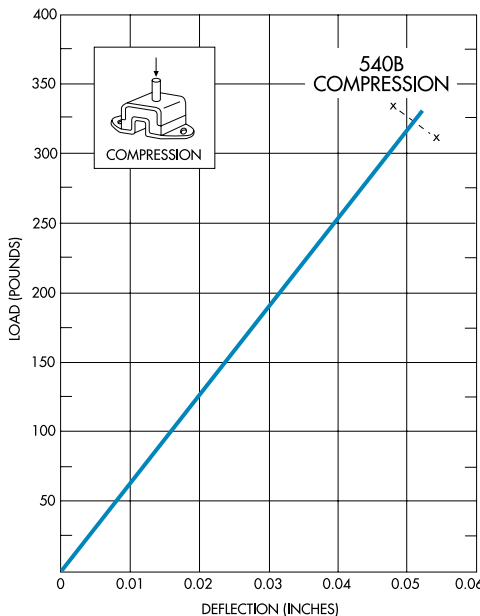



## SERIES 600 HEAVY-DUTY CENTER-BOLT SAFETY MOUNTINGS

- This ESTCO Heavy-Duty Center-Bolt Safety Mounting Series is a versatile group of one-piece, low-deflection safety mountings designed for multidirectional isolation in heavy-duty applications. The mountings are rated by static load in the axial direction and dynamic loads up to three times the rated load can be handled. Although static loads in the radial direction are not recommended, dynamic radial loads are acceptable. The resilient element compressed during installation spreads at one end to form a self-contained rebound member. It features a bonded steel bushing that acts as a positive spacer. To install, lubricate the end of the mounting lightly with soapy water and, with an arbor press, push on the bushing to seat the mounting in the bore of the supporting member. Tightening the bolt until stopped by the integral spacer completes the installation.

### SELECTION GUIDE

MOUNTING STYLE	LOAD RANGE (LBS)
620	20-140
630	50-520
640	100-720
641	100-720
645	150-1100
650	200-1500
660	300-2400

### DIMENSIONS

MOUNTING STYLE	DIMENSIONS (IN.)									
	A	B	C	D	E (MIN)	F (MIN)	G	H	I	R (MIN)
620	.31	.19	.69	.40	1.25	1.10	.81	.75	1.09	.06
630	.38	.38	1.00	.47	2.00	1.50	1.24	1.12	1.75	.06
640	.62	.45	1.38	.53	2.25	1.70	1.35	1.25	2.00	.06
641	.62	.45	1.38	.64	2.25	1.70	1.35	1.25	2.00	.06
645	.75	.56	1.75	.64	2.85	2.20	1.61	1.50	2.50	.06
650	.93	.71	2.00	.64	3.50	2.50	1.96	1.81	2.97	.12
660	.75	.94	2.12	.77	4.25	2.70	2.20	2.00	3.68	.12

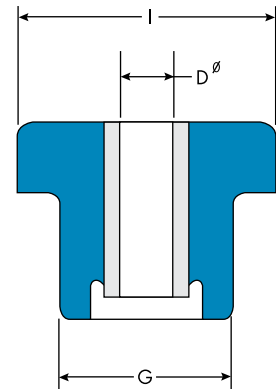
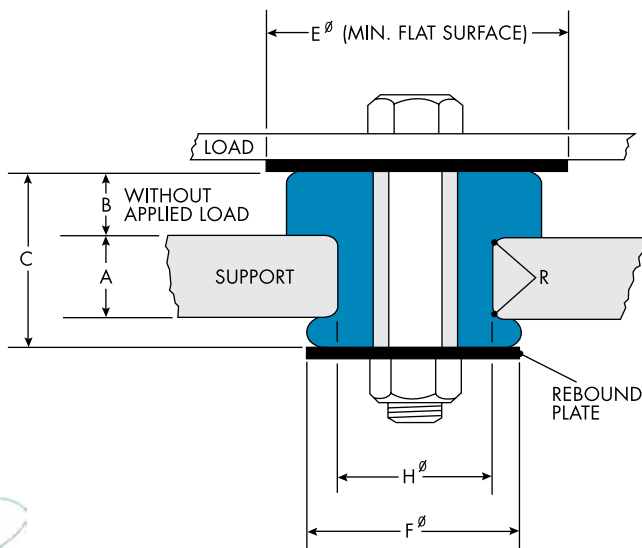

ISO 9001 Certified  
CERTIFICATE # 08-511

# SERIES 600 HEAVY-DUTY CENTER-BOLT SAFETY MOUNTINGS

Styles: **MM620/630** For loads to 520 pounds



## SELECTION GUIDE

STYLE 620		MINIMUM LOAD FOR 81% ISOLATION (LBS)			
LOAD RATING	MAXIMUM LOAD (LBS)	FORCING FREQUENCY IN CYCLES PER MINUTE			
		1500	2000	2250	2500
B	30		25	20	15
C	50		50	35	30
D	80			75	60
E	140				130

## SELECTION GUIDE

STYLE 630		MINIMUM LOAD FOR 81% ISOLATION (LBS)			
LOAD RATING	MAXIMUM LOAD (LBS)	FORCING FREQUENCY IN CYCLES PER MINUTE			
		1500	2000	2250	2500
B	130	110	70	50	40
C	190		140	100	70
D	300		260	190	130
E	520		520	380	260

## LOAD DEFLECTION GRAPHS

Deflections below the line X—X are considered safe practice for static loads; data above that line are useful for calculating deflections under dynamic loads

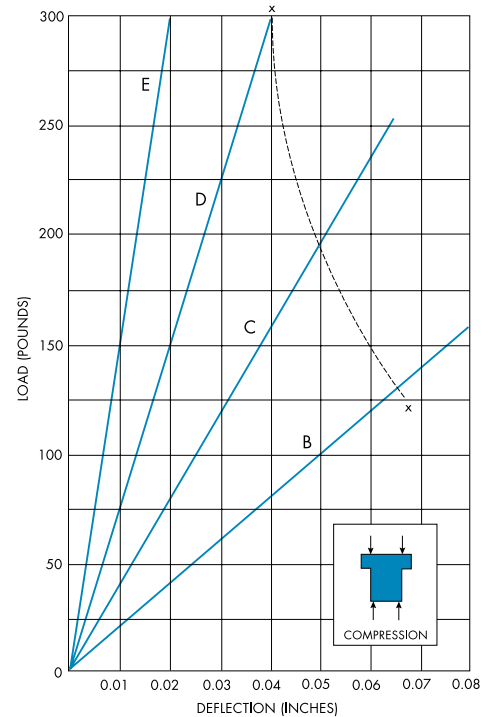
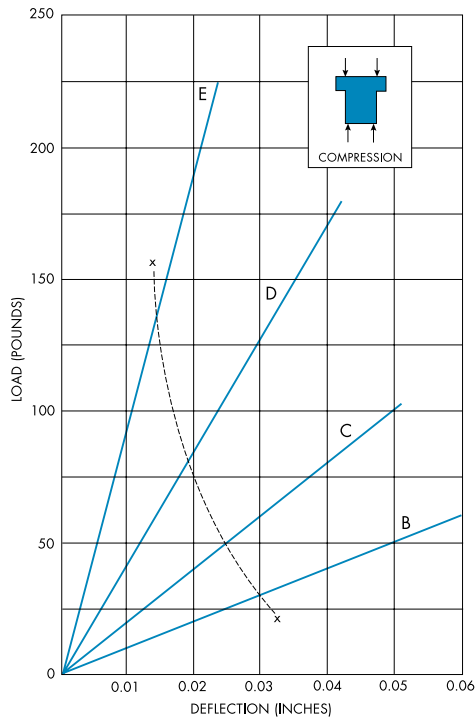



**SERIES 600**  
**HEAVY-DUTY CENTER-BOLT**  
**SAFETY MOUNTINGS**

Styles: **MM640/645** For loads to 1100 pounds

**SELECTION GUIDE**

STYLE 640/641		MINIMUM LOAD FOR 81% ISOLATION (LBS)			
LOAD RATING	MAXIMUM LOAD (LBS)	FORCING FREQUENCY IN CYCLES PER MINUTE			
		2000	2500	3000	3600
B	230	190	120	90	60
C	360	330	200	150	100
D	520		370	260	180
E	720		630	450	300

**SELECTION GUIDE**

STYLE 645		MINIMUM LOAD FOR 81% ISOLATION (LBS)				
LOAD RATING	MAXIMUM LOAD (LBS)	FORCING FREQUENCY IN CYCLES PER MINUTE				
		1750	2000	2500	3000	3600
B	400	320	250	160	110	80
C	540	540	410	260	190	130
D	750		710	450	320	220
E	1100			780	560	380

**LOAD DEFLECTION GRAPHS**

Deflections below the line X---X are considered safe practice for static loads; data above that line are useful for calculating deflections under dynamic loads

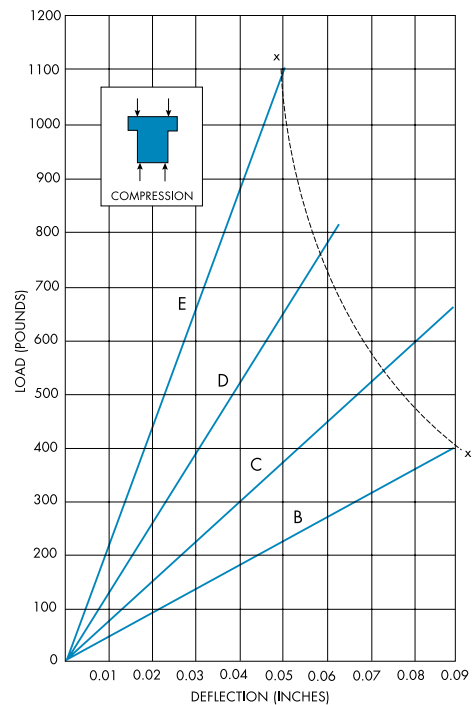
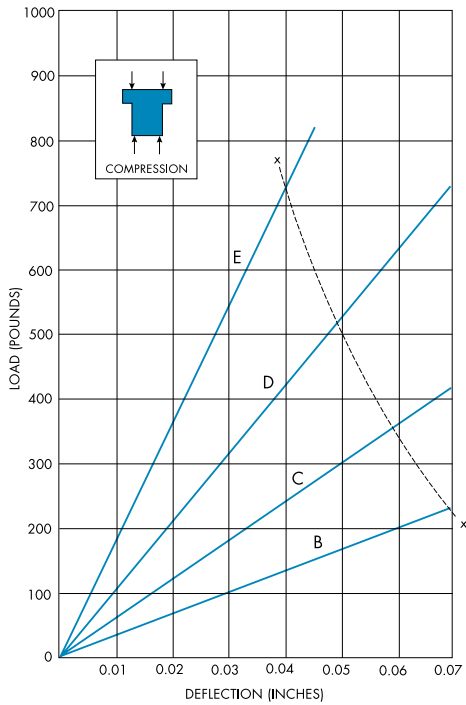



# SERIES 600 HEAVY-DUTY CENTER-BOLT SAFETY MOUNTINGS

Style: **MM650** For loads to 1500 pounds



## SELECTION GUIDE

STYLE 650		MINIMUM LOAD FOR 81% ISOLATION (LBS)					
LOAD RATING	MAXIMUM LOAD (LBS)	FORCING FREQUENCY IN CYCLES PER MINUTE					
		1500	1750	2000	2500	3000	3600
B	600	520	380	300	200	130	100
C	800		650	500	320	230	150
D	1100		1100	830	530	380	260
E	1500			1400	900	630	430

## LOAD DEFLECTION GRAPH

Deflections below the line X---X are considered safe practice for static loads; data above that line are useful for calculating deflections under dynamic loads

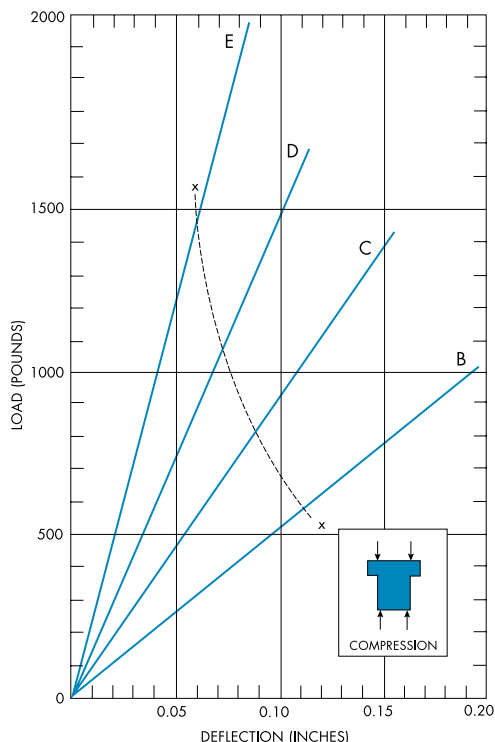

- This ESTCO Heavy-Duty Center-Bolt Safety Mounting Series is a versatile group of one-piece, low-deflection safety mountings designed for multidirectional isolation in heavy-duty applications. The mountings are rated by static load in the axial direction and dynamic loads up to three times the rated load can be handled. Although static loads in the radial direction are not recommended, dynamic radial loads are acceptable. The resilient element compressed during installation spreads at one end to form a self-contained rebound member. It features a bonded steel bushing that acts as a positive spacer. To install, lubricate the end of the mounting lightly with soapy water and, with an arbor press, push on the bushing to seat the mounting in the bore of the supporting member. Tightening the bolt until stopped by the integral spacer completes the installation.





**SERIES 600**  
**HEAVY-DUTY CENTER-BOLT**  
**SAFETY MOUNTINGS**

Style: **MM660** For loads to 2400 pounds

- This ESTCO Heavy-Duty Center-Bolt Safety Mounting Series is a versatile group of one-piece, low-deflection safety mountings designed for multidirectional isolation in heavy-duty applications. The mountings are rated by static load in the axial direction and dynamic loads up to three times the rated load can be handled. Although static loads in the radial direction are not recommended, dynamic radial loads are acceptable. The resilient element compressed during installation spreads at one end to form a self-contained rebound member. It features a bonded steel bushing that acts as a positive spacer. To install, lubricate the end of the mounting lightly with soapy water and, with an arbor press, push on the bushing to seat the mounting in the bore of the supporting member. Tightening the bolt until stopped by the integral spacer completes the installation.

**SELECTION GUIDE**

STYLE 660		MINIMUM LOAD FOR 81% ISOLATION (LBS)						
LOAD RATING	MAXIMUM LOAD (LBS)	FORCING FREQUENCY IN CYCLES PER MINUTE						
		1250	1500	1750	2000	2500	3000	3600
B	950	950	670	500	500	240	170	120
C	1300		1050	800	600	400	270	180
D	1850		1800	1350	1000	650	450	300
E	2400			2000	1550	1000	700	500

**LOAD DEFLECTION GRAPH**

Deflections below the line X---X are considered safe practice for static loads; data above that line are useful for calculating deflections under dynamic loads

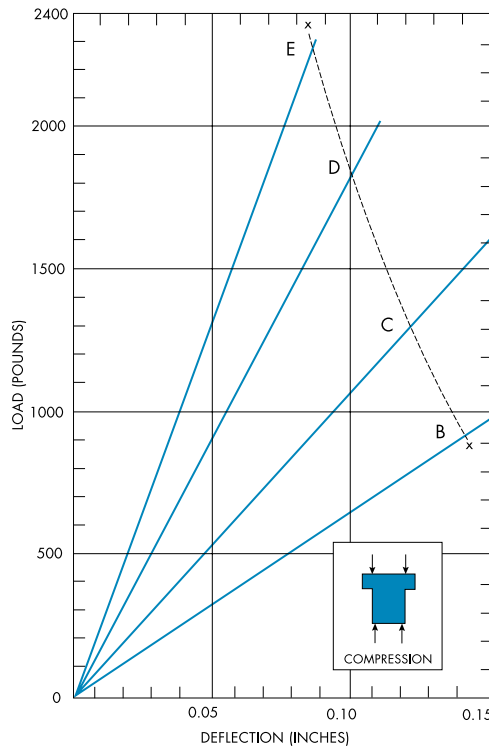

**SERIES 1000**

**CUSTOM MOLDED MOUNTING FEET**

Styles: **MM1020/9624/9690**

For loads to 62 pounds (1020), 100 pounds (9624), 130 pounds (9690)



**MM1020 - RUBBER BUMPERS SELECTION GUIDE**

MOUNTING STYLE	STATIC LOAD (LBS)	OCCASIONAL DYNAMIC LOAD (LBS)
1020A	44	80
1020B	49	100
1020C	56	122
1020D	62	145

- Custom molded mounting feet are an excellent and efficient way to reduce vibration and movement on industrial equipment and machinery. They are ideal for equipment which is “walking” on solid floors or concrete due to machinery vibration.

END STUD (IN.)		
THREAD	LENGTH	SUFFIX
5/16-18	9/16	76
5/16-18	1/2	68
5/16-18	3/4	70
5/16-18	11/8	74
5/16-24	3/4	94
5/16-24	1 3/4	92

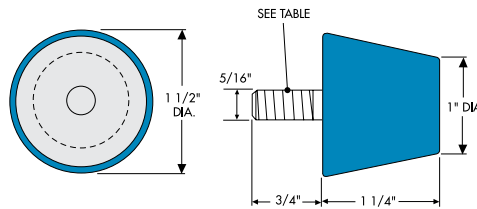

**MM9624 - RUBBER BUMPERS SELECTION GUIDE**

PART #	DIA (in.)	T (in.)	THREAD	S (in.)
9624-155	1 3/4"	3	5/16-18	5/8"

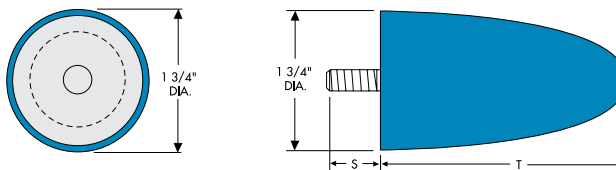

**MM9690 - RUBBER BUMPERS SELECTION GUIDE**

MOUNTING STYLE	STATIC LOAD (LBS)	OCCASIONAL DYNAMIC LOAD (LBS)
9690 A	92	168
9690 B	102	210
9690 C	117	256
9690 D	130	304

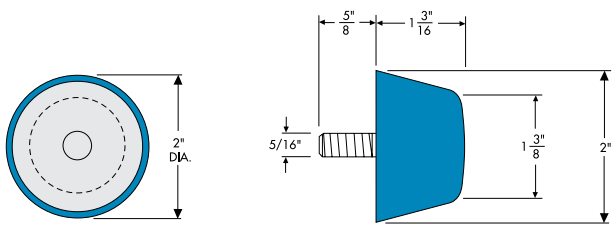



**SERIES 5000**  
**BONDED BUSHING AND SNUBBER**

Style: **MM5000**

For loads to 580 pounds

- ESTCO's 5000 Series Bonded Bushings and snubber Mounts are designed to absorb extreme static and dynamic forces. This system also absorbs forces in the rebound mode. These mounts are designed for engines, cabs, and auxiliary equipment for the on and off highway, military, farm, and construction vehicles.

- **Typical applications:**
- Engines
- Vehicular Cabs
- Vehicular Electronics.
- Radiators
- Gas tanks
- Transmission Cases

**SELECTION GUIDE**

PART NUMBER	RATED (lbs) AXIAL LOAD	RATED (lbs) RADIAL LOAD	A	B	C	D	E (REF)	F	G (REF)	H
5001-01 5001-02 5001-03 5001-04 5001-05	35 80 103 235 280	18 27 36 45 55	1.25	.50	1.25	.39	.52	.78	.53	.37
5002-01 5002-02 5002-03 5002-04 5002-05	65 125 170 275 390	45 80 125 190 290	1.94	.78	1.87	.53	.77	1.31	.78	.50
5003-01 5003-02 5003-03 5003-04 5003-05	100 180 250 350 500	80 120 175 265 370	2.50	.90	2.53	.64	.89	1.54	.90	.75
5004-01 5004-02 5004-03 5004-04 5004-05	150 300 400 500 600	110 220 300 400 580	2.88	1.0	3.5	.94	1.35	2.30	1.36	1.00
5006-01 5006-02 5006-03 5006-04 5006-05	35 80 103 235 280	18 27 36 45 55	1.00	.50	1.25	.39	.52	.78	.53	.125
5007-01 5007-02 5007-03 5007-04	35 80 103 235	18 27 36 45	1.00	.50	1.25	.32	.52	.78	.53	.125

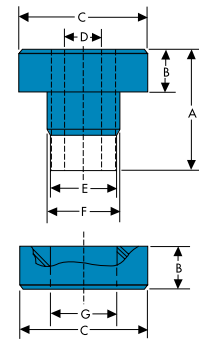
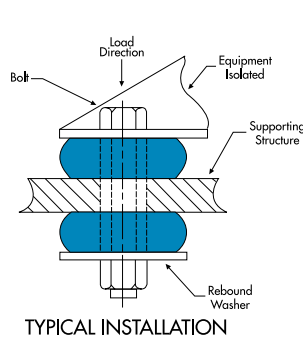

**SERIES 9000**  
**CYLINDRICAL MOUNTING PADS**

Style: **MM9000**



**SELECTION GUIDE**

PART NUMBER	DIAMETER	PAD HEIGHT	STUD LENGTH	THREAD	STATIC LOAD
mm9801	3/8	5/16	3/8	6..32	5
mm9803	3/8	3/8	3/8	6..32	7
mm9805	7/16	7/16	3/8	6..32	9
mm9807	7/16	1/2	3/8	6..32	10
mm9809	3/8	1/4	3/8	8..32	5
mm9811	3/8	5/32	3/8	8..32	5
mm9813	3/8	1/2	3/8	8..32	8
mm9815	3/8	5/16	3/8	8..32	6
mm9817	7/16	1/2	3/8	8..32	11
mm9819	1/2	3/4	3/8	8..32	35
mm9821	9/16	1/2	3/8	8..32	16
mm9823	9/16	3/4	3/8	8..32	35
mm9825	5/8	1/2	3/8	8..32	17
mm9827	3/4	1/2	3/8	8..32	35
mm9829	3/4	1	3/8	8..32	39
mm9831	9/16	1/2	3/8	10..32	16
mm9833	9/16	5/16	3/8	10..32	12
mm9835	5/8	15/16	3/8	10..32	20
mm9837	3/4	5/8	3/8	10..32	37
mm9839	1	3/8	3/8	10..32	37
mm9841	1	3/4	3/8	10..32	60

- ESTCO's 9000 series bumper pads are an easy and economical method to absorb energy and isolate mechanical vibration on equipment or instrumentation. They are available in a variety of compounds and durometers to meet your specifications. Most are also available with threaded female inserts.

\* Most parts also available with female inserts.

continued/next page

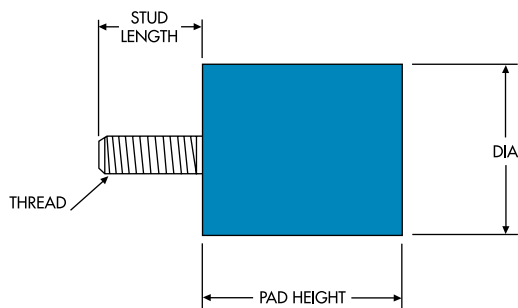



## SERIES 9000 CYLINDRICAL MOUNTING PADS

Style: **MM9000**

- ESTCO's 9000 series bumper pads are an easy and economical method to absorb energy and isolate mechanical vibration on equipment or instrumentation. They are available in a variety of compounds and durometers to meet your specifications. Most are also available with threaded female inserts.

### SELECTION GUIDE

PART NUMBER	DIAMETER	PAD HEIGHT	STUD LENGTH	THREAD	STATIC LOAD
mm9843	5/8	5/8	1/2	1/4..20	17
mm9845	3/4	3/8	1/2	1/4..20	35
mm9847	3/4	1/2	1/2	1/4..20	36
mm9849	1	3/8	1/2	1/4..20	35
mm9851	3/4	5/8	1/2	1/4..20	37
mm9853	3/4	3/4	1/2	1/4..20	38
mm9855	1	17/32	1/2	1/4..20	54
mm9857	1	3/4	1/2	1/4..20	60
mm9859	1	5/8	1/2	1/4..20	57
mm9861	1	1	1/2	1/4..20	62
mm9863	1 1/4	3/4	1/2	1/4..20	100
mm9865	1 1/4	1	1/2	1/4..20	115
mm9867	1	5/8	1/2	5/16..18	56
mm9869	1	17/32	1/2	5/16..18	54
mm9871	1	3/4	1/2	5/16..18	60
mm9873	1	3/8	1/2	5/16..18	35
mm9875	1	1	1/2	5/16..18	62
mm9877	3/4	3/4	1/2	5/16..18	38
mm9879	1	1 1/4	5/8	5/16..18	63
mm9881	1	1 1/2	5/8	5/16..18	65
mm9883	1 1/4	3/4	9/16	5/16..18	100
mm9885	1 1/4	1	9/16	5/16..18	112
mm9887	1 1/4	1 1/4	9/16	5/16..18	90
mm9889	1 3/8	5/8	9/16	5/16..18	158
mm9891	1 3/8	1	9/16	5/16..18	110
mm9893	1 3/8	1 1/2	9/16	5/16..18	148
mm9895	1 1/2	1	9/16	5/16..18	100
mm9897	2	1 3/4	9/16	5/16..18	250
mm9899	2	1	9/16	5/16..18	175
mm9901	2	1 3/16	9/16	5/16..18	195

\* Most parts also available with female inserts.

continued/next page

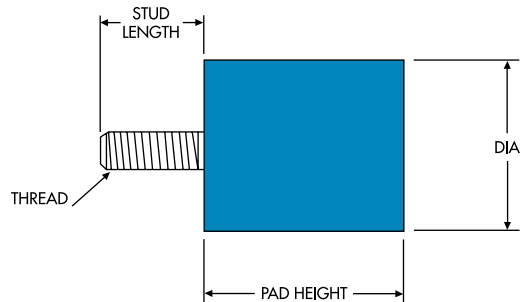

**SERIES 9000**  
**CYLINDRICAL MOUNTING PADS**

Style: **MM9000**



**SELECTION GUIDE**

PART NUMBER	DIAMETER	PAD HEIGHT	STUD LENGTH	THREAD	STATIC LOAD
mm9903	1	3/4	3/4	3/8..16	60
mm9905	1	1	3/8	3/8..16	62
mm9907	1 1/2	1	3/4	3/8..16	100
mm9909	1 3/8	1	3/4	3/8..16	110
mm9911	1 1/2	3/4	1 5/16	3/8..16	90
mm9913	2	1 1/2	3/4	3/8..16	165
mm9915	2	1 3/4	3/4	3/8..16	280
mm9917	2	2 1/8	3/4	3/8..16	325

- ESTCO's 9000 series bumper pads are an easy and economical method to absorb energy and isolate mechanical vibration on equipment or instrumentation. They are available in a variety of compounds and durometers to meet your specifications. Most are also available with threaded female inserts.

\* Most parts also available with female inserts.

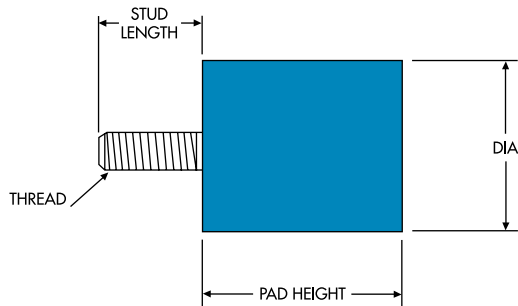

# WIRE PROTECTION & POWER COMPONENTS

CONTACT ESTCO FOR MORE PRODUCT INFORMATION



Cable Clamps, Push & Snap Lock



Cable Ties



Cable Wrap



Lockit Hose Clamps



Nylon Cable Clamps



Nylon Hose Clamps & Nylon Strap Mates



Nylon Rivets, Arrow Clips & Push-in Fasteners

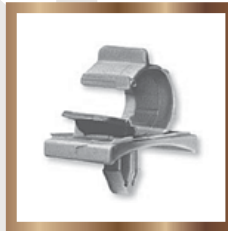

Push Mount Wire Clips



Push Mount Wire Clips

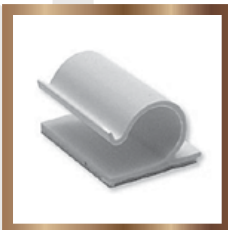

“J” & “C” Style Wire Clips



“P” Style Wire and Cable Holder & Lockit Loops

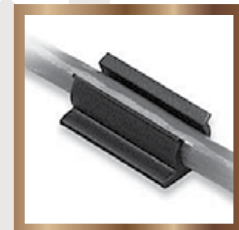

“U” Style Wire Clips



# SAFETY GEAR



Apparel & Hi-Viz Wear

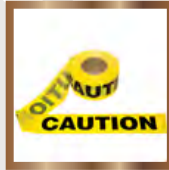

Barricade Tape



Confined Space



Emergency Response



Ergonomics



Eye Protection

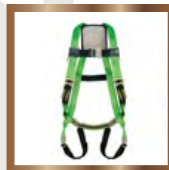

Fall Protection



First Aid



Footwear



Hand Protection



Hazardous Storage



Head & Face Protection



Hearing Protection



Heat Stress

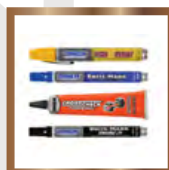

Industrial Markers



Instrumentation

**CALL OR VISIT OUR WEBSITE TO LEARN MORE**

## SAFETY GEAR CONTINUED



Jobsite Safety



Lighting



Lockout/  
Tagout



Marking Tapes



Outdoor



Printer

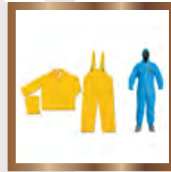

Protective  
Clothing



Respiratory



Safety Cutters



Showers &  
Eyewash



Signs



Sorbents



Tapes &  
Adhesives



Water Safety

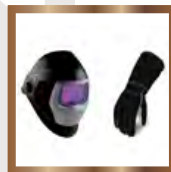

Welding &  
FR Safety



Wipes &  
Cleaners

**CALL OR VISIT OUR WEBSITE TO LEARN MORE**

## SAFETY GEAR CONTINUED: GLOVES



Gloveworks Blue Latex Exam Powder Free Disposable Gloves (500 Gloves Case)



Ammex Professional Ivory Latex Exam Powder Free Disposable Gloves (1000 Gloves/Case)



Gloveworks Hd Ivory Latex Industrial Powder Free Disposable Gloves (1000 Gloves/Case)



Ammex Lx3 Ivory Latex Industrial Powder Free Disposable Gloves (1000 Gloves/Case)



Gloveworks Ivory Latex Industrial Powdered Disposable Gloves (1000 Gloves/Case)



Ammex Gpx3 Clear Vinyl Industrial Latex Free Disposable Gloves (1000 Gloves/Case)



Gloveworks Black Synthetic Vinyl Disposable Gloves (1000 Gloves/Case)



Gloveworks Black Vinyl Powder Free Industrial Gloves (1000 Gloves/Case)



Gloveworks Clear Vinyl Industrial Powdered Disposable Gloves (1000 Gloves/Case)



Gloveworks Ivory Latex Industrial Powder Free Disposable Gloves (1000 Gloves/Case)



Gloveworks Clear Vinyl Industrial Latex Free Disposable Gloves (1000 Gloves/Case)



Gloveworks Blue Vinyl Industrial Latex Free Disposable Gloves (1000 Gloves/Case)



Ammex Clear Vinyl Exam Latex Free Disposable Gloves (1000 Gloves/Case)



Ammex Stretch Synthetic Blue Vinyl Pf Exam Gloves (1000 Gloves/Case)



Ammex Ivory Stretch Vinyl Exam Latex Free Disposable Gloves (1000 Gloves/Case)



Ammex Black Medical Nitrile Exam Latex Free Disposable Gloves (1000 Gloves/Case)



Ammex Indigo Nitrile Exam Latex Free Disposable Gloves (1000 Gloves/Case)



Ammex Blue Nitrile Exam Latex Free Disposable Gloves (1000 Gloves/Case)



Gloveworks Black Nitrile Industrial Latex Free Disposable Gloves (1000 Gloves/Case)



Gloveworks Blue Nitrile Exam Latex Free Disposable Gloves (1000 Gloves/Case)



Gloveworks Black Nitrile Exam Latex Free Disposable Glove (1000 Gloves/Case)



Gloveworks Hd Green Nitrile Industrial Latex Free Disposable Gloves (1000 Gloves/Case)



Gloveworks Hd Black Nitrile Industrial Latex Free Disposable Gloves (1000 Gloves/Case)



Gloveworks Hd Royal Blue Nitrile Latex Free Disposable Gloves (1000 Gloves/Case)



Gloveworks Hd Orange Nitrile Industrial Latex Free Disposable Gloves (1000 Gloves/Case)



Gloveworks Blue Nitrile Industrial Latex Free Disposable Gloves (1000 Gloves/Case)



Ammex X3 Blue Nitrile Industrial Latex Free Disposable Gloves (1000 Gloves/Case)



X3 Ultra Nitrile Powder Free Disposable Gloves (1000 Gloves/Case)



Bx3 (1000 Gloves/Case)



Ammex Exam Blue Nitrile Pf Disposable Gloves (1000 Gloves/Case)



X3 Clear Poly Disposable Gloves (100 Gloves/Box)



X3 Clear Poly Disposable Gloves (500 Gloves/Box)



X3 Stretch Hybrid Poly Disposable Gloves (1000 Gloves/Case)

**CALL OR VISIT OUR WEBSITE TO LEARN MORE**

# ESTCO

From Facility to Everyday Utility

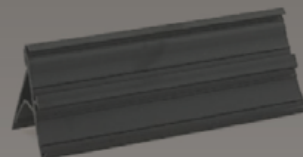
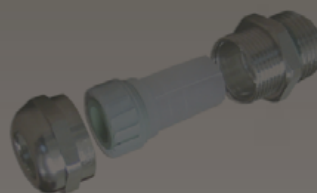

**CONTACT OUR CUSTOMER  
SERVICE DEPARTMENT TODAY!**



888.696.7826  
760.489.8745  
FAX: 760.489.9117



[sales@estcoenterprises.com](mailto:sales@estcoenterprises.com)



[estcoenterprises.com](http://estcoenterprises.com)



1549 Simpson Way  
Escondido, CA 92029